

**MECHANIZED INFANTRY
PLATOON AND SQUAD
(BRADLEY)**

AUGUST 2002

**HEADQUARTERS
DEPARTMENT OF THE ARMY**

DISTRIBUTION RESTRICTION: Approved for public release; distribution is unlimited.

MECHANIZED INFANTRY PLATOON AND SQUAD (BRADLEY)

CONTENTS

	Page
PREFACE	vii
CHAPTER 1. THE ROLE OF THE MECHANIZED INFANTRY RIFLE PLATOON (BRADLEY FIGHTING VEHICLE)	
Section I. Mechanized Infantry Rifle Platoon Employment	1-1
1-1. Close Combat.....	1-1
1-2. Combat Power.....	1-2
1-3. Capabilities	1-3
1-4. Limitations.....	1-4
1-5. Considerations for Tactical Employment	1-4
Section II. Mechanized Infantry Rifle Platoon (Bradley Fighting Vehicle)	
Organization	1-4
1-6. Mounted Element.....	1-5
1-7. Dismounted Element.....	1-5
1-8. Responsibilities.....	1-6
CHAPTER 2. COMMAND, CONTROL, AND THE TROOP-LEADING PROCEDURES	
Section I. Command and Control.....	2-1
2-1. Leadership.....	2-1
2-2. Mission Command.....	2-2
Section II. Plans and Orders	2-3
2-3. Mission Statement	2-3
2-4. Combat Orders.....	2-4
Section III. Troop-Leading Procedures	2-6
2-5. Receive the Mission.....	2-6
2-6. Issue a Warning Order	2-6
2-7. Make a Tentative Plan	2-7

DISTRIBUTION RESTRICTION: Approved for public release; distribution is unlimited.

*This publication supersedes FM 7-7J, 7 May 1993.

	Page
2-8. Initiate Movement.....	2-20
2-9. Conduct Reconnaissance	2-20
2-10. Complete the Plan.....	2-21
2-11. Issue the Operations Order	2-21
2-12. Supervise and Refine	2-21

CHAPTER 3. TACTICAL MOVEMENT

3-1. Mounted Movement Formations	3-1
3-2. Dismounted Movement Formations	3-6
3-3. Movement Techniques.....	3-9
3-4. Actions at Danger Areas.....	3-13
3-5. Security During Movement	3-19
3-6. Maneuver	3-19

CHAPTER 4. OFFENSIVE OPERATIONS

Section		I. Fundamentals of Offensive Operations	4-1
		4-1. Characteristics of Offensive Operations.....	4-1
		4-2. Types of Offensive Operations.....	4-2
		4-3. Forms of Maneuver.....	4-3
Section		II. Sequence of Offensive Operations	4-6
		4-4. Assembly Area.....	4-7
		4-5. Reconnaissance.....	4-7
		4-6. Movement to the Line of Departure	4-7
		4-7. Maneuver	4-7
		4-8. Deployment.....	4-8
		4-9. Assault	4-8
		4-10. Consolidation and Reorganization.....	4-8
Section		III. Battlefield Operating Systems Planning Considerations.....	4-8
		4-11. Maneuver	4-9
		4-12. Fire Support	4-9
		4-13. Mobility, Countermobility, and Survivability	4-9
		4-14. Air Defense.....	4-9
		4-15. Combat Service Support	4-9
Section		IV. Actions on Contact	4-9
		4-16. Deploy and Report.....	4-10
		4-17. Evaluate and Develop the Situation.....	4-10
		4-18. Choose a Course of Action	4-12
		4-19. Recommend and Execute a Course of Action	4-12
Section		V. Movement to Contact	4-13
		4-20. Planning Considerations	4-13
		4-21. Approach March Technique	4-16
		4-22. Search and Attach Technique	4-17
Section		VI. Attack	4-18
		4-23. Reconnaissance.....	4-19

		Page
	4-24.	Movement to the Objective 4-20
	4-25.	Isolate the Objective 4-22
	4-26.	Seize a Foothold and Exploit the Penetration (Actions on the Objective) 4-22
	4-27.	Consolidation and Reorganization 4-23
Section	VII.	Special Purpose Attacks 4-24
	4-28.	Ambush 4-25
	4-29.	Raid 4-32
	4-30.	Counterattack 4-33
	4-31.	Spoiling Attack 4-33
	4-32.	Feint 4-33
	4-33.	Demonstration 4-34
Section	VIII.	Offensive Tactical Tasks 4-34
	4-34.	Seize 4-34
	4-35.	Clear 4-37
	4-36.	Suppress 4-40
	4-37.	Attack by Fire 4-41
	4-38.	Bypass 4-42
 CHAPTER 5. DEFENSIVE OPERATIONS		
Section	I.	Characteristics of the Defense 5-1
	5-1.	Preparation 5-1
	5-2.	Security 5-1
	5-3.	Disruption 5-1
	5-4.	Massing Effects 5-2
	5-5.	Flexibility 5-2
Section	II.	Sequence of the Defense 5-2
	5-6.	Reconnaissance and Security Operations and Enemy Preparatory Fires 5-2
	5-7.	Occupation 5-3
	5-8.	Approach of the Enemy Main Attack 5-4
	5-9.	Enemy Assault 5-4
	5-10.	Counterattack 5-5
	5-11.	Consolidation and Reorganization 5-6
Section	III.	Battlefield Operating Systems Planning Considerations 5-6
	5-12.	Maneuver 5-6
	5-13.	Fire Support 5-8
	5-14.	Mobility, Countermobility, and Survivability 5-9
	5-15.	Air Defense 5-12
	5-16.	Combat Service Support 5-12
Section	IV.	Engagement Area Development 5-12
	5-17.	Identify Likely Enemy Avenues of Approach 5-12
	5-18.	Identify the Enemy Scheme of Maneuver 5-13
	5-19.	Determine Where to Kill the Enemy 5-13

		Page
	5-20. Emplace Weapon Systems.....	5-13
	5-21. Plan and Integrate Obstacles.....	5-14
	5-22. Plan and Integrate Indirect Fires.....	5-14
	5-23. Conduct an Engagement Area Rehearsal	5-15
Section	V. Occupation and Preparation of Defensive Positions	5-16
	5-24. Occupation of Defensive Positions.....	5-16
	5-25. Priority of Work.....	5-18
	5-26. Security in the Defense.....	5-19
	5-27. Establishment of Defensive Positions	5-20
	5-28. Weapons Placement.....	5-22
	5-29. Coordination	5-25
Section	VI. Defensive Techniques.....	5-26
	5-30. Defend in Sector	5-26
	5-31. Defend a Battle Position	5-27
	5-32. Defend a Strong Point.....	5-31
	5-33. Defend a Perimeter	5-34
	5-34. Defend on a Reverse Slope.....	5-36
Section	VII. Retrograde Operations	5-38
	5-35. Withdrawal.....	5-38
	5-36. Delay.....	5-46
	5-37. Retirement.....	5-46
Section	VIII. Fighting and Survivability Positions	5-46
	5-38. Principles	5-47
	5-39. Standard Designs	5-51
	5-40. Types of Fighting Positions.....	5-52
	5-41. Vehicle Positions	5-57
	5-42. Trenches.....	5-60

CHAPTER 6. URBAN OPERATIONS

Section	I. Offense.....	6-1
	6-1. Task Organization (Platoon Attack of a Building).....	6-2
	6-2. Movement	6-5
	6-3. Assaulting a Building	6-7
	6-4. Conduct of the Breach	6-10
	6-5. Enter and Clear a Building	6-14
	6-6. Consolidation and Reorganization.....	6-17
	6-7. Continuation of the Assault Mission	6-18
Section	II. Defense	6-18
	6-8. Planning the Defense	6-18
	6-9. Hasty Defense.....	6-19
	6-10. Priorities of Work and Defensive Considerations	6-21
	6-11. Conduct of the Defense.....	6-28
	6-12. Consolidation and Reorganization.....	6-28
	6-13. Counterattack.....	6-28

		Page
Section	III. Combat Multipliers	6-29
	6-14. Armored Vehicles	6-29
	6-15. Engineers	6-32
	6-16. Mortars	6-32
	6-17. Field Artillery	6-34
	6-18. Attack Helicopters	6-34
	6-19. Antiarmor Weapons	6-35
	6-20. Snipers	6-35
CHAPTER 7. TACTICAL ENABLING OPERATIONS		
	7-1. Reconnaissance	7-1
	7-2. Linkup Operations	7-4
	7-3. Passage of Lines	7-6
	7-4. Relief in Place	7-8
	7-5. Air Assault Operations	7-10
	7-6. Area Security Operations	7-11
	7-7. Convoy and Route Security	7-12
	7-8. Checkpoints, Roadblocks, and Observation Points	7-21
CHAPTER 8. COMBAT SUPPORT		
Section	I. Indirect-Fire Support	8-1
	8-1. Fire Planning	8-2
	8-2. Fire Support Matrix	8-2
	8-3. Call for Fire	8-3
	8-4. Adjust Fire	8-6
	8-5. Mortar Support	8-12
	8-6. Field Artillery Support	8-13
	8-7. Fire Direction Assets	8-14
	8-8. Fire Request Channels	8-14
	8-9. Close Air Support	8-16
	8-10. Attack Helicopters	8-18
Section	II. Combat Engineer Support	8-20
	8-11. Engineer Organization	8-20
	8-12. Mobility	8-21
	8-13. Countermobility	8-21
	8-14. Survivability	8-21
Section	III. Air Defense	8-22
	8-15. Active Air Defense	8-22
	8-16. Passive Air Defense	8-26
	8-17. Air Defense Warnings	8-26
CHAPTER 9. COMBAT SERVICE SUPPORT		
	9-1. Individual Responsibilities	9-1
	9-2. Planning Considerations	9-1

	Page
9-3. Resupply Operations.....	9-3
9-4. Combat Load and Basic Load.....	9-6
9-5. Maintenance.....	9-6
9-6. Evacuation Procedures.....	9-6
9-7. Killed in Action	9-6
9-8. Enemy Prisoners of War	9-7
9-9. Aerial Sustainment.....	9-7
9-10. Casualty Evacuation	9-7
APPENDIX A. PLATOON ORGANIZATION, SEATING, AND VEHICLE DISMOUNT DRILLS.....	A-1
APPENDIX B. M240B MACHINE GUN AND M249 SQUAD AUTOMATIC WEAPON EMPLOYMENT.....	B-1
APPENDIX C. RISK MANAGEMENT.....	C-1
APPENDIX D. FRATRICIDE AVOIDANCE.....	D-1
APPENDIX E. BATTLE DRILLS AND CREW DRILLS.....	E-1
APPENDIX F. JAVELIN EMPLOYMENT	F-1
APPENDIX G. FIRE CONTROL AND DISTRIBUTION TECHNIQUES.....	G-1
APPENDIX H. RANGE CARDS AND SECTOR SKETCHES.....	H-1
APPENDIX I. M2A3 BRADLEY FIGHTING VEHICLE CONSIDERATINS	I-1
GLOSSARY.....	Glossary-1
REFERENCES.....	References-1
INDEX.....	Index-1

PREFACE

This manual describes the operations and capabilities of the Bradley fighting vehicle (BFV)-equipped infantry rifle platoon. It is based on the platoons equipped with the M2A2-ODS, but still applies to all variations of the BFV. It takes into account the reorganization of this platoon, which incorporates three rifle squads. It introduces the enhanced capabilities of the M2A3 BFV and M2A2-ODS BFV (with Applique) equipped with FBCB2. This manual also describes the doctrinal and tactical employment principles for the BFV-equipped infantry rifle platoon. Tactics and techniques in the manual apply both to digital and analog platoons during planning, preparation, and execution are provided.

This manual provides the platoon leader, BFV commanders, and squad leaders with tactics and techniques to exploit infantry rifle platoon capabilities. Although this manual reemphasizes critical information from other manuals, the user must continue to refer to other manuals when referenced for in-depth discussions of certain subjects.

The proponent of this publication is the U.S. Army Infantry School. Send comments and recommendations for improving this manual to doctrine@benning.army.mil or on DA Form 2028 (Recommended Changes to Publications and Forms) to Commandant, U.S. Army Infantry School, ATTN: ATSH-ATD, Fort Benning, Georgia 31905-5000; DSN: 835-4704; commercial: (706) 545-5107.

Unless this publication states otherwise, masculine nouns and pronouns do not refer exclusively to men.

CHAPTER 1

**THE ROLE OF THE MECHANIZED INFANTRY RIFLE
PLATOON (BRADLEY FIGHTING VEHICLE)**

The mission of the mechanized infantry is to close with the enemy using fire and movement to defeat or capture him, or to repel his assault by fire, close combat, or counterattack. Among other things, the mechanized infantry relies on the principles of war and the dynamics of combat power. These basics apply at both platoon and squad levels. This chapter discusses the doctrinal principles of the mechanized infantry rifle platoon. Platoon and squad tactics, techniques, procedures, and drills rely on these principles. It also discusses the skills required of leaders and soldiers at the small-unit level.

Section I. MECHANIZED INFANTRY RIFLE PLATOON EMPLOYMENT

Despite any technological advantages our armed forces might have over an enemy, the *only* way to gain the decision in battle is by close combat between ground forces. Mechanized infantry rifle forces equipped with the Bradley fighting vehicle (BFV) play the following main roles in close combat situations:

- Operate mainly at night or during other periods of natural or induced limited visibility.
- Penetrate and hold existing (natural and man-made) obstacles and difficult terrain as pivots for operational and tactical maneuver.
- Attack over approaches not feasible for armored forces.
- Seize or secure forested and built-up areas.
- Control restrictive routes for use by other forces.
- Conduct rear area operations.

1-1. CLOSE COMBAT

BFV-equipped infantry rifle platoons and rifle squads normally operate as part of a larger force. They benefit from the support of armor, artillery, mortars, close air support, helicopters, air defense, and engineers. They also provide their own suppressive fires either to repel enemy assaults or to support their own maneuver.

a. During close combat, platoon leaders consider the following to determine how to employ the BFVs.

- Support the rifle squads with direct fires.
- Provide mobile protection to transport rifle squads to the critical point on the battlefield.
- Suppress or destroy enemy infantry fighting vehicles and other lightly armored vehicles.
- Destroy enemy armor with TOW fires.

b. Success in battle hinges on the actions of platoons, sections, and rifle squads in close combat. It also depends on their ability to react to contact; employ suppressive fires; maneuver to an enemy's vulnerable flank; and fight through to defeat, destroy, or

capture an enemy. For success, the BFV-equipped infantry rifle platoon relies on the ability of leaders and soldiers to—

- Use the potential of both the rifle squads and the BFV.
- Operate their weapons with accuracy and deadly effect.
- Outthink, outmaneuver, and outfight the enemy.
- Use terrain to their advantage.

1-2. COMBAT POWER

The elements of combat power (maneuver, firepower, protection, leadership, and information) guide the employment of all infantry forces.

a. **Maneuver.** Maneuver is the employment of forces on the battlefield through movement in combination with fire or fire potential. Its purpose is to achieve a position of advantage with respect to the enemy in order to accomplish the mission. Mechanized infantry forces move to gain and hold a position of advantage over the enemy. In the offense, they maneuver to attack enemy flanks, rear areas, logistics points, and command posts. In the defense, they maneuver to counterattack a flank of the enemy attack. When properly supported by fire, maneuver allows the rifle squads to close with the enemy and gain a decision in combat.

b. **Firepower.** Firepower is the amount of fire a position, unit, or weapons system can deliver. Firepower destroys or suppresses the enemy in his positions, deceives him, and supports maneuver. Without effective supporting fires, the rifle squads could not effectively maneuver. However, before trying to maneuver rifle squads, the platoon leader should establish a base of fire with the BFVs.

(1) A base of fire is direct fire placed on an enemy force or position to reduce or eliminate the enemy's ability to interfere with friendly maneuver. A single weapon or group of weapon systems can provide a base of fire. More effective is a base of fire generated by the BFVs (or another platoon) for the desired effect and for the length of time required.

(2) Leaders must know how to control, mass, and combine fire with maneuver. They must identify the most critical targets quickly. As soon as they do that, they direct fires onto those targets. They try to place sufficient direct and indirect fires on the enemy to keep him from returning fire effectively as well as to keep the platoon from using ammunition needlessly.

c. **Protection.** Protection means preserving the fighting potential of an element so that it can apply that potential with maximum force at the decisive time and place. Platoons must never let the enemy get an unexpected advantage. Rifle platoons and squads take active and passive measures to protect themselves from surprise, observation, detection, interference, espionage, sabotage, and annoyance. Protection has four components: force protection, field discipline, safety, and fratricide avoidance. The platoon leader's includes two basic considerations include—

(1) **Care of the Soldier and His Equipment.** The rifle platoon and squad use sustainment techniques to maintain effectiveness as a fighting force. Soldiers keep themselves healthy to maintain their morale. They observe personal hygiene, physical conditioning, and rest plans. They also keep their equipment in good working condition, and maintain and protect their supplies.

(2) **Actions to Counter Enemy Combat Power.** The rifle platoon and squad use security, dispersion, cover, camouflage, and deception. To protect themselves when stationary for any length of time, they dig fighting positions. They use terrain skillfully while moving mounted. They dismount the rifle squads to increase protection. They employ obscuration as necessary. They overwatch other moving elements and provide suppressive fires when required. They attempt to set the time and place of battle. They must protect themselves, so that they can engage the enemy with power and surprise.

d. **Leadership.** Military leadership is a process by which one soldier influences others to accomplish a mission. Leaders coordinate the other elements of combat power—competent and confident leadership produces effective unit action. The right leadership gives purpose, direction, and motivation in combat. Leaders must know their profession, their soldiers, and the tools of war. Only leaders who embody the warrior ethos can inspire and direct soldiers to do difficult tasks under dangerous and stressful conditions. Leadership is the most important element of combat power.

e. **Information.** Information enhances leadership and magnifies the effects of maneuver, firepower, and protection at decisive points. Leaders know and understand the broader tactical situation, which allows them to develop plans that incorporate the other elements of combat power during a decisive action. Information also allows them to make crucial decisions during execution to increase the opportunity for success.

1-3. CAPABILITIES

In accomplishing its assigned missions, the platoon employs combat support (CS) and combat service support (CSS) assets within its capabilities. The platoon's effectiveness depends on the synergy of its subordinate elements, including its BFVs and the rifle squads. To employ the platoon effectively, the platoon leader capitalizes on its strengths. The BFV-equipped mechanized infantry platoon can—

- Assault enemy positions.
- Assault with small arms and indirect fires to deliver rifle squads to tactical positions of advantage.
- Use 25-mm cannon and 7.62-mm machine gun fire to effectively suppress or destroy the enemy's infantry.
- Block dismounted avenues of approach.
- Seize and retain key and decisive terrain.
- Clear danger areas and prepare positions for mounted elements.
- Conduct mounted or dismounted patrols and operations in support of security operations.
- Develop the situation with soldiers (three rifle squads) and equipment (25-mm cannon, TOW, and 7.62-mm coaxial machine gun).
- Establish strong points to deny the enemy important terrain or flank positions.
- Infiltrate enemy positions.
- Overwatch and secure tactical obstacles.
- Repel enemy attacks through close combat.
- Conduct assault breaches of obstacles.
- Participate in air assault operations.
- Destroy light armor vehicles using direct fire from the BFV.

- Employ 25-mm cannon fire to fix, suppress, or disrupt the movement of fighting vehicles and antiarmor systems up to 2,500 meters.
- Use TOW fires to destroy tanks and fighting vehicles out to 3,750 meters.
- Use Javelin fires to destroy tanks and fighting vehicles out to 2,000 meters.
- Operate in a nuclear, biological, and chemical (NBC) environment.
- Participate in stability operations.
- Participate in support operations.

1-4. LIMITATIONS

The platoon leader must also understand the limitations of the BFV-equipped mechanized infantry rifle platoon to effectively employ the platoon—

- BFVs are vulnerable to enemy antiarmor fires.
- Rifle squads are vulnerable to small arms and indirect fires when not mounted.
- The foot speed of the dismounted infantryman may establish the pace of operations.
- The BFV poses a variety of challenges in water-crossing operations. Among other things, the platoon could have difficulty finding adequate fording sites or a bridge with a sufficient weight classification.

1-5. CONSIDERATIONS FOR TACTICAL EMPLOYMENT

Leaders must consider the following guidelines when employing mechanized infantry during the full spectrum of operations.

- a. Squads and platoons fight through enemy contact at the lowest possible level. Upon enemy contact, all soldiers and leaders must act at once and follow up. Battle drills are standard procedures that help the platoon take immediate action.
- b. Before they can maneuver, squads or platoons in contact *must* establish effective suppressive fires and gain fire superiority. If the platoon or squad cannot move under its own fires, the leader must request support from higher headquarters. Once they gain fire superiority, they maneuver against an enemy position. The BFVs suppress the enemy, move to a dismount location (if caught in the open), and dismount the rifle squads. The BFVs quickly build a base of fire for the rifle squads to maneuver.

Section II. MECHANIZED INFANTRY RIFLE PLATOON (BRADLEY FIGHTING VEHICLE) ORGANIZATION

The mechanized infantry rifle platoon is equipped with four BFVs and is divided into two elements: mounted and dismounted. Figure 1-1 depicts the BFV-equipped mechanized infantry rifle platoon organization. The platoon can fight as unified mutually supporting maneuver elements or as two distinct maneuver elements—one mounted and one dismounted (Refer to Appendix A for details on platoon organization and seating of the dismounted squads.). The platoon must prepare to fight in a variety of operational environments. Once the rifle squads have dismounted, the mounted element provides a base of fire for the rifle squads as they close with and destroy the enemy.

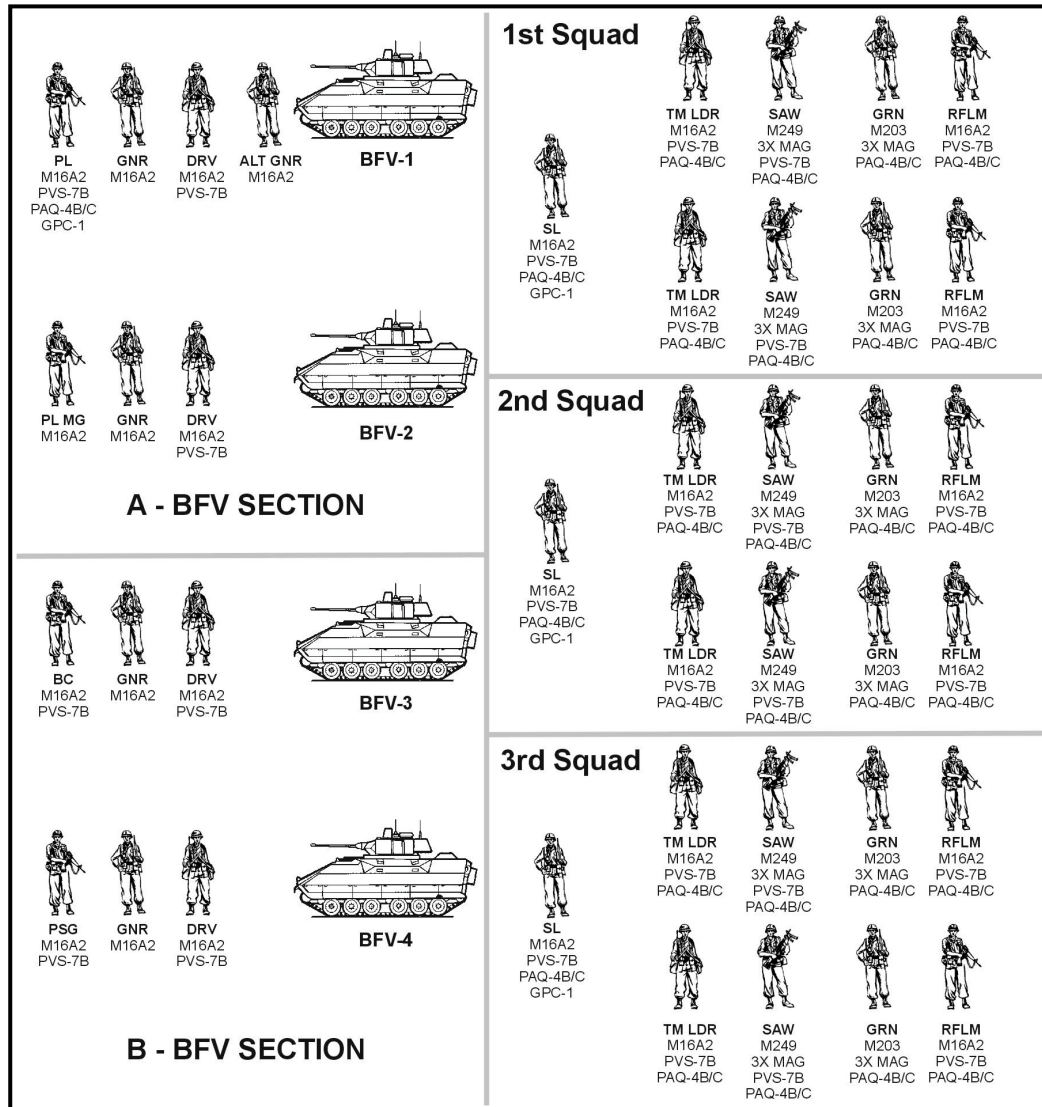

Figure 1-1. Platoon organization.

1-6. MOUNTED ELEMENT

The mounted element consists of four BFVs that are organized into two sections (A and B) with two vehicles each—the platoon leader (or platoon sergeant) vehicle and the section leader (wingman) vehicle.

1-7. DISMOUNTED ELEMENT

Three nine-man rifle squads make up the platoon’s dismounted element. The rifle squad has two, four-man fire teams and a squad leader. Each squad has a CLU and an M240B machine gun. Two riflemen in the squad train and qualify on the M240B and the Javelin. One serves as the M240B (or Javelin) gunner and the other serves as the M240B (or Javelin) assistant gunner, when directed. (Refer to Appendix B for a discussion of the M240B characteristics and employment and Appendix F for a discussion of the employment of the Javelin).

1-8. RESPONSIBILITIES

The employment of the BFV by well-trained and proficient soldiers enhances the platoon's capabilities to conduct operations with greater *lethality, survivability, command and control, and mobility*.

NOTE: The M2A3 has more equipment than previous models of the BFV. This equipment is also more complex than that on earlier models, which requires more cross training to ensure soldiers can fill vacancies or shortfalls in critical positions. Also, because the M2A3 BFV platoon can transfer more information at every level, soldiers must work together more closely than ever before.

a. **Platoon Leader.** The platoon leader bears the responsibility for all that the platoon does or fails to do. This includes the tactical employment, collective training, administration, personnel management, and logistics of his platoon. He must know his soldiers and how to employ the platoon and its weapons. He bears personal responsibility for positioning and employment of all assigned or attached weapons. His list of responsibilities and duties are as follows:

- Leads the platoon in supporting the company and battalion missions. Bases his actions on the mission the company commander assigns him, the concepts of the company and battalion commanders, and his own estimate of the situation.
- Sets the example and the standards.
- Normally dismounts when the situation causes the platoon to dismount.
- Serves as BC when mounted.
- Informs the commander of his actions when operating without orders.
- Plans operations with the help of the platoon sergeant, section leaders, squad leaders, and other key personnel.
- Stays abreast of the situation and goes where needed to supervise, issue FRAGOs, and accomplish the mission.
- Requests from the company commander any support needed to help the platoon perform its mission.
- Helps the platoon sergeant plan and coordinate CSS for the platoon.
- Receives on-hand status reports from the platoon sergeant, section leaders and squad leaders during planning.
- Reviews platoon requirements based on the tactical plan.
- Develops the fire support plan with the platoon sergeant, section leaders, and squad leaders.
- Coordinates the obstacle plan.
- Analyzes tactical situations, disseminates and filters information, and employs the full capabilities of his platoon's equipment (digital or analog) to accomplish the mission.
- Manages C2 information.
- Ensures SITREPs are accurately prepared and sent forward to the company commander.

- Analyzes, and then disseminates to subordinates, pertinent tactical friendly and enemy updates.
- Employs all available assets during limited visibility to designate targets for the direct- and indirect-fire weapons and for situational updates.

b. **Platoon Sergeant.** The platoon leader should consider the platoon sergeant a fighter by trade and place him in the tactical plan either dismounted or maneuvering the mounted element. The platoon sergeant is the senior NCO and most experienced soldier in the platoon. He assists and advises the platoon leader. In the platoon leader's absence, he leads the platoon. He supervises the platoon's administration, logistics, and maintenance. He supervises individual training. He advises the platoon leader on appointments, promotions and reductions, assignments, and discipline of NCOs and enlisted soldiers in the platoon. His *tactical expertise* in platoon operations includes maneuver of the platoon and employment of all weapons. The platoon sergeant also—

- Controls the mounted element when the platoon leader dismounts; or, dismounts with, commands, and controls the platoon when necessary (METT-TC dependent).
- Updates or ensures someone else updates the platoon leader on appropriate reports, and forwards any reports needed by higher headquarters.
- Takes charge of task-organized elements in the platoon during tactical operations, which can include, but is not limited to, quartering parties, support elements in raids or attacks, and security patrols.
- Serves as a BC when the platoon operates mounted.
- Monitors the morale, discipline, and health of platoon members.
- Ensures soldiers maintain all equipment.
- Coordinates and supervises company-directed platoon resupply operations.
- Collects, prepares, and forwards logistical status updates and requests to the company headquarters.
- Ensures ammunition and supplies are properly and evenly distributed after the platoon consolidates on the objective and while the platoon reorganizes.
- Ensures platoon has an adequate amount of batteries on hand.
- Directs the platoon's casualty evacuation process during mounted or dismounted operations.
- Maintains platoon strength information, consolidates and forwards the platoon's casualty reports, and receives and orients replacements.
- Receives section and squad leaders' administrative, logistical, and maintenance reports and requests for rations, water, fuel, and ammunition.
- Ensures soldiers distribute supplies IAW the platoon leader's guidance and direction.

c. **Section Leader.** The section leader assists and advises the platoon leader in the employment of the mounted section. The section leader is responsible for the tactical employment and maintenance of the BFVs within the section. He is also responsible for the individual training of the section's personnel. He is the BC for his BFV.

d. **Platoon Master Gunner.** The platoon master gunner serves as the platoon leader's technical expert on gunnery and turret weapon systems and is the Bradley commander of BFV-3. During combat or field exercises, he advises the platoon leader

and platoon sergeant about BFV weapons effects, capabilities, and safety. He also advises him about fire control measures and preparation. He is the lead technical trainer for the mounted element, under the routine supervision of the platoon sergeant. He helps the platoon leader set up the gunnery task for training.

e. **Bradley Commander.** The platoon leader, platoon sergeant, and the two section leaders serve as the Bradley commander for their BFVs. In the platoon leader's absence (when dismounted), his gunner assumes the responsibilities of the BC. The BC, who remains mounted,—

- Acquires targets.
- Commands the vehicle relative to the section and platoon.
- Controls vehicle fires.
- Ensures the welfare of the crew.
- Holds the vehicle's position in platoon formations.
- Issues fire commands.
- Lays the gun for deflection.
- Maintains the BFV hull and turret.
- Maintains the BFV weapon systems.
- Monitors his CTD for vehicle position, digital overlays, and digital reports (in FBCB2-equipped units).
- Navigates correctly.
- Sends SITREPs as requested or when the vehicle makes contact
- Trains soldiers to use weapons.

f. **Bradley Gunner.** The gunner observes the battlefield to detect enemy targets. He operates the turret weapons as directed by the BC to engage and destroy targets. When only two men remain in the BFV, which occurs rarely, he serves as BC. He bears the responsibility for performing unit-level maintenance on the turret and its weapons systems. He also helps with navigation and with radio operation.

g. **Bradley Driver.** The driver operates the vehicle under the BC's control. The driver follows terrain-driving procedures and tries to select hull-down positions. He also helps detect targets and observe rounds fired. He helps with navigation by monitoring odometer readings and observing terrain. He bears the main responsibility for maintaining the vehicle's automotive (hull) systems.

h. **Rifle Squad Leader.** The rifle squad leader bears the responsibility for all the squad does or fails to do. He is a tactical leader—he leads by example. The rifle squad leader's duties include the following:

- Accounts for soldiers and equipment.
- Completes casualty feeder reports and reviews casualty reports completed by squad members.
- Controls the maneuver of his squad and its rate and distribution of fire: controls two fire teams in the offense; selects each fighting position in the defense; issues commands, codes, and signals to start, stop, and shift fires.
- Directs maintenance of squad weapons and equipment.
- Ensures soldiers in the squads each receive the allotted material and supplies.
- Ensures supplies and equipment are internally cross-leveled within the squad.
- Helps to maintain the hull.

- Informs the platoon leader and platoon sergeant regularly as to the squad's supply status and other squad requirements.
 - Inspects the condition of soldier's weapons, clothing, and equipment.
 - Manages the logistical and administrative needs of his squad. Requests and issues ammunition, water, rations, and special equipment.
 - Passes appropriate information to his team leaders.
 - Sends SITREPs and reports as requested by the platoon leader or platoon sergeant.
 - Trains his squad on individual and collective tasks required to sustain combat effectiveness.
- i. **Team Leader.** Each squad has two fire team leaders, who lead by example. Each team leader is associated with a specific BFV and—
- Controls the fire team's movement and fires.
 - Helps the squad leader control the squad tactically.
 - Helps the squad leader train team members on individual and collective tasks and battle drills.
 - Keeps soldiers in the troop compartment well informed and alert.
 - Sends digital SITREPs as requested by the squad leader or as his team makes contact.
 - Controls the team's fire and distribution by designating and marking targets.
- j. **Squad Members.** Squad members provide any local security needed; they also provide maintenance support for the BFV. Each squad member is equally responsible for the welfare of his squad.
- (1) **Rifleman.** Each infantry squad has two riflemen. Each rifleman is equipped with an M16A2 or M4. One rifleman is designated as the antiarmor specialist (see below). The other rifleman in each squad is assigned the M240B under an "arms room" concept, meaning that the leader will decide which weapon to employ resulting from an analysis of the factors of METT-TC.
- (2) **Antiarmor Specialist.** As the designated Javelin and AT4 gunner, the squad antiarmor specialist has a Javelin AT missile system. This weapon system gives the squad, platoon, and company a lethal fire-and-forget, man-portable, top attack antiarmor capability. With it, they can defeat enemy main battle tanks during day, night, and adverse weather conditions up to 2,000 meters. If required, the squad antiarmor specialist destroys enemy armor threats that might impede the squad or platoon's progress.
- (3) **Grenadier.** The grenadier has an M203 weapon system, which consists of an M16 rifle with attached 40-mm grenade launcher. With the M203, the grenadier gives the fire team an indirect-fire capability out to 350 meters. He can fire high-explosive (HE) rounds to suppress and destroy enemy infantry and lightly armored vehicles. He can also employ smoke to screen and cover his squad's movement, fire, and maneuver. During night and adverse weather conditions, the grenadier can also employ illumination rounds to increase the squad's visibility and to mark enemy or friendly positions.
- (4) **Automatic Rifleman.** Each infantry squad has two automatic weapons. The automatic rifleman mainly uses the M249 squad automatic weapon. The M249 gives the squad a high volume of sustained, long-range, suppressive, or lethal fires far beyond the range of the M16 or M4 rifle. The automatic rifleman uses the M249 to suppress enemy

infantry and bunkers, to destroy enemy automatic rifle and antitank teams, and to enable other teams and squads to maneuver.

CHAPTER 2
**COMMAND, CONTROL, AND
THE TROOP-LEADING PROCEDURES**

Command and control (C2) is the process of directing, coordinating and controlling the unit to accomplish the mission. The purpose of command and control is to implement the commander's will in pursuit of the unit's objective. Command and control is both a system and a process. The essential component for both the process and the system is leadership.

Leadership is influencing people—by providing purpose, direction, and motivation—while operating to accomplish the mission. Purpose gives soldiers a reason to do tasks. Direction communicates the way to accomplish the mission. Motivation gives soldiers the will to accomplish the mission.

This chapter provides techniques and procedures used by Infantry platoons, squads, and sections for C2. It describes troop-leading procedures (TLP), communications in combat, and operation orders. Technical enhancements in an M2A2-ODS (with Applique) or M2A3-equipped platoon provide leaders several significant improvements in C2. Even with these technical enhancements, the platoon and squad leaders must use proven techniques of mission tactics and leadership because the vehicles may not always be in close proximity or in a position to assist in communication. The plan must be clearly articulated in the orders process and rehearsed by all.

Section I. COMMAND AND CONTROL

Command and control refers to the process of directing, coordinating, and controlling a unit to accomplish a mission. Command and control implement the commander's will in pursuit of the unit's objective. The two components of C2 are the *commander* and the *C2 system*. At platoon level, the *C2 system* consists of the personnel, information management, procedures, and equipment the platoon leader uses to carry out the operations process (plan, prepare, execute, and assess) within his platoon.

2-1. LEADERSHIP

Leadership means influencing people by providing purpose, direction, and motivation to accomplish a mission. Leadership is the most vital component of command and control. (Refer to FM 22-100 for additional information on leadership.)

- a. **Purpose.** Purpose gives soldiers a *reason* to accomplish the mission.
- b. **Direction.** Direction gives them the *means* to accomplish the mission.
- c. **Motivation.** Motivation gives them the *will* to accomplish the mission.
- d. **Communications.** To command or control, leaders *must* communicate with their subordinates.

2-2. MISSION COMMAND

Mission encourages and helps subordinates to act within the intent and concept of both the battalion and company commanders. Mission command requires subordinate elements to clearly understand the purpose and commander's intent (two levels up). This allows them the freedom to respond, with disciplined initiative, to threat actions without further guidance. With mission command, the platoon leader must—

a. **Expect Uncertainty.** The platoon leader must understand the impact of information and how it capability impacts on the environment of combat. Dynamic battle conditions, an uncooperative threat, and the chaos—the noise and confusion—of battle challenge the platoon leader's ability to know what is happening in his immediate area of operations (AO). Through a common operational picture (COP), he must try to understand and envision the evolving battle beyond his personal knowledge and senses. Using all of his personal, technical, and tactical resources helps him to develop the situation and reduce uncertainty. The situation the leader anticipates during planning many times will change, which requires assessment and flexible, dynamic leadership during the execution of current operations.

b. **Reduce Leader Intervention.** Too much control stifles subordinate initiative. When soldiers expect the platoon or squad leader to make every decision or initiate every action, they may become reluctant to act. To counter this tendency, the platoon leader must plan and direct operations in a manner that requires a minimum of intervention. The platoon leader must operate on the principle that well-trained subordinates with a clear understanding of the mission will accomplish the intended purpose.

c. **Optimize Planning Time for Subordinates.** The platoon leader must ensure that the timelines he develops for planning and preparation provide adequate time for his subordinate leaders to conduct their TLP.

d. **Allow Maximum Freedom of Action for Subordinates.** Given the expected battlefield conditions, leaders at every level must avoid unnecessary limits on their soldiers' freedom of action. The leader at the decisive point must have the knowledge, training, and freedom to make the correct choice in support of both the battalion and company commanders' intent. This concept must be emphasized at every opportunity and at every level of leadership. Soldiers win battles. The leaders responsibility is to place soldiers in a position where they can seize the opportunity to win battles.

e. **Encourage Cross Talk.** Squad and team leaders sometimes need no guidance from the platoon leader in order to address a change in the situation. In some instances, because of their position on the battlefield, two or more subordinates working together may have on-site information, thus providing the clearest view of what is happening. This becomes critical to the platoon leader as he refines his common operational picture (COP) and develops the tactical solution. This type of problem solving involving direct coordination between subordinate elements is essential to mission command.

f. **Lead Well Forward.** The platoon leader positions himself where he can best employ his platoon and make critical decisions to influence the outcome of the fight. He normally chooses a position with the main effort. This way, he can control his elements and support the main effort as needed. From his far forward position, he can use all of the available resources and technology to visualize the battlefield. In addition to visual observation, intelligence resources also include radio reports and, if available, information provided via the Force XXI battle command brigade and below (FBCB2)

system (M2A3-equipped units). The platoon sergeant normally stays with the mounted element. He must be able to assume the responsibilities of the platoon leader rapidly, if needed.

g. **Maintain the Common Operational Picture.** The commander structures the battlefield based on his intent and on the factors of METT-TC. How he does this affects the platoon leader's planning and his ability to maintain his COP. The framework of the battlefield can vary, ranging from one extreme to the other. At one extreme, the battlefield could have obvious front and rear (linear) boundaries and closely tied adjacent (contiguous) units. At the other, it could consist of a dispersed, decentralized (noncontiguous) structure with few secure areas and unit boundaries and no definable front or rear boundary (nonlinear), with many variations. Maintaining the COP becomes tougher as the battlefield loses structure. Modern, highly mobile operations involving small forces lend themselves to a less rigid framework. To visualize the battlefield accurately, the platoon leader must know the friendly situation one level higher. Whenever possible, he shares what he knows with the section and squad leaders. The platoon leader must also know the terrain and weather and the enemy situation. He must picture enemy and friendly elements through time as well as picture how the terrain will affect their actions. Analyzing the situation—

- Helps leaders form logical conclusions, make decisions that anticipate future events and information, and, if time is short, conduct TLP as fast as possible.
- Provides a basis for platoon leaders, platoon sergeants, section leaders, and squad leaders to make sound, quick tactical decisions.
- Reduces fratricide.

Section II. PLANS AND ORDERS

Plans are the basis for any mission. To develop his plan (concept of the operation), the platoon leader summarizes how best to accomplish his mission within the scope of the commander's intent two levels up. The platoon leader uses TLP to turn the concept into a fully developed plan and to prepare a concise, accurate operations order (OPORD). He assigns additional tasks (and outlines their purpose) for subordinate elements, allocates available resources, and establishes priorities to make the concept work. The platoon leader and his subordinates must have a thorough understanding of planning for everything else that the platoon does.

2-3. MISSION STATEMENT

The platoon leader uses the mission statement to summarize the upcoming operation. This brief paragraph (sometimes a single sentence) describes the type of operation, the unit's tactical task and purpose, the actions to be taken, and the reasons for these actions. It is written based on the five "Ws:" who (unit), what (tasks), when (date-time group), where (grid location or geographical reference for the area of operations or objective), and why (purpose). The platoon leader must ensure that the mission is thoroughly understood by all leaders and soldiers two echelons down. The following paragraphs cover considerations that apply in development of the mission statement.

a. **Operations.** Operations are groupings of related activities in four broad categories: offense, defense, stability, and support.

b. **Tasks.** Tactical tasks are specific activities performed by the unit while it is conducting a tactical operation or a form of maneuver. (The title of each task can also be used as an action verb in the unit’s mission statement to describe actions during the operation.) Tasks should be definable, attainable, and measurable. Tactical tasks that require specific tactics or techniques for the platoon are covered in detail throughout this manual. Figure 2-1 gives examples of tactical tasks the platoon and its subordinate elements may be called upon to conduct.

<p>Destroy Disrupt Fix Suppress Block</p>	<p>Seize Secure Clear Isolate Breach</p>	<p>Follow and support Follow and assume Support by fire Attack by fire Retain</p>
--	---	--

Figure 2-1. Examples of tactical tasks.

c. **Purpose.** A simple, clearly stated purpose tells the subordinates why the platoon is conducting the mission and how the platoon will operate with or provide support for other units.

2-4. COMBAT ORDERS

Combat orders are the means by which the platoon leader receives and transmits information, from the earliest notification that an operation will occur through the final steps of execution. Warning orders, operations orders, and fragmentary orders are absolutely critical to mission success. In a tactical situation, the platoon leader and subordinate leaders work with combat orders on a daily basis, and they must have precise knowledge of the correct format for each type of order. At the same time, they must ensure that every soldier in the platoon understands how to receive and respond to the various types of orders. The skills associated with orders are highly perishable; therefore, the platoon leader must take every opportunity to train the platoon in the use of combat orders with realistic practice.

a. **Warning Order.** Platoon leaders alert their platoons by using a warning order (WARNO) during the planning for an operation. Warning orders also initiate the platoon leader’s most valuable time management tool—parallel planning. The platoon leader may issue a series of warning orders to his subordinate leaders to help them prepare for new missions. The directions and guidelines in the warning order allow subordinates to begin their own planning and preparation activities.

(1) The content of warning orders is based on two major variables: information available about the upcoming operation and special instructions. The information usually comes from the company commander. The platoon leader wants his subordinates to take appropriate action, so he normally issues his warning orders either as he receives additional orders from the company or as he completes his own analysis of the situation.

(2) In addition to alerting the unit to the upcoming operation, warning orders allow the platoon leader to issue tactical information incrementally and, ultimately, to shorten the length of the actual OPORD. Warning orders do not have a specific format, but generally follow the five-paragraph OPORD format. Table 2-1 shows an example of how

the platoon leader might use warning orders to alert the platoon and provide initial planning guidance.

PLATOON LEADER'S ACTION	POSSIBLE CONTENT OF WARNING ORDER	PLATOON LEADER'S PURPOSE
Receive company WARNO #1	Warning order #1 covers: Security plan. Movement plan. Tentative timeline. Standard drills to be rehearsed.	Prepare squads and vehicles for movement to the tactical assembly area. Obtain map sheets. Initiate generic rehearsals (drill- and task-related).
Receive company WARNO #2 or Conduct METT-TC analysis	Warning order #2 covers: Friendly situation. Enemy situation. Terrain analysis. Platoon mission.	Initiate squad-level mission analysis. Prepare for combat.
Receive company WARNO #3 or Receive company OPORD or Develop a tentative plan	Warning order #3 covers: Concept of the operation. Concept of fires. Subordinate unit tasks and purposes. Updated graphics.	Identify platoon-level reconnaissance requirements. Direct leader's reconnaissance. Prepare for combat.

Table 2-1. Example of multiple warning orders.

b. **Operations Order.** The operations order (OPORD) is the five-paragraph directive issued by a leader to subordinates for the purpose of effecting the coordinated execution of an operation. When time and information are available, the platoon leader will normally issue a complete OPORD as part of his troop-leading procedures; however, after issuing a series of warning orders, he does not need to repeat information previously covered. He can simply review previously issued information or brief the changes or earlier omissions. He will then have more time to concentrate on describing his concept of the fight to his subordinates. As noted in his warning orders, the platoon leader may also issue an execution matrix, either to supplement the OPORD or as a tool to aid in the execution of the mission; however, the matrix does not replace a five-paragraph OPORD.

c. **Fragmentary Order.** A fragmentary order (FRAGO) is a brief verbal or written order. A written FRAGO should follow the five-paragraph OPORD structure; however, it includes only the changes to previous information required for subordinates to accomplish their mission. The platoon leader uses a FRAGO to—

- Communicate changes in the enemy or friendly situation.
- Task subordinate elements based on changes in the situation.
- Implement timely changes to existing orders.
- Provide pertinent extracts from more detailed orders.
- Specify instructions for subordinates who do not need a complete order.

NOTE: To enhance understanding of verbal FRAGOs, M2A3-equipped units can quickly develop graphics and transmit digital overlays.

Section III. TROOP-LEADING PROCEDURES

The TLPs begin when the platoon leader receives the first indication of an upcoming mission and continue throughout the operations process (plan, prepare, execute, and assess). The TLP comprise a sequence of actions (Figure 2-2) that help platoon leaders use available time effectively and efficiently to issue and execute tactical operations. TLP are not a hard and fast set of rules. They are a guide that must be applied consistent with the situation and the experience of the platoon leader and his subordinate leaders. The tasks involved in some actions (such as initiate movement, issue the warning order, and conduct reconnaissance) may recur several times during the process. The last action, (activities associated with supervising and refining the plan) occurs continuously throughout TLP. The following information concerning the TLP assumes that the platoon leader will plan in a time-constrained environment. As such, the suggested techniques are oriented to help a platoon leader quickly develop and issue a combat order.

Receive the Mission
Issue a Warning Order
Make a Tentative Plan
Initiate Movement
Conduct Reconnaissance
Complete the Plan
Issue the Operations Order
Supervise and Refine

Figure 2-2. Troop-leading procedures.

2-5. RECEIVE THE MISSION

This step begins with the receipt of an initial WARNO from the company. It may begin when the platoon leader receives the commander's OPORD, or it may result from a change in the overall situation. Receiving the mission initiates planning and preparation for a mission. At this stage of the TLP, mission analysis should focus on determining the unit's mission and the amount of available time. For the platoon leader, mission analysis is essentially the analysis of the mission, enemy, terrain and weather, troops, available time (friendly and enemy), and civil considerations (METT-TC). The platoon leader must not become involved in a detailed METT-TC analysis. This will occur after he issues the initial WARNO.

2-6. ISSUE A WARNING ORDER

After the platoon leader determines the platoon's mission and gauges the time available for planning, preparation and execution, he immediately issues an oral WARNO to his subordinates. In addition to telling his subordinates of the platoon's new mission, the WARNO also gives them the platoon leader's planning timeline. The platoon leader relays all other instructions or information that he thinks will assist the platoon in preparing for the new mission. Such information includes information about the enemy, the nature of the overall plan, and specific instructions for preparation. Most importantly, by issuing the initial WARNO as quickly as possible, the platoon leader enables his subordinates to begin their own planning and preparation while he begins to develop the platoon operation order. This is called parallel planning.

2-7. MAKE A TENTATIVE PLAN

After receiving the company order (WARNO, OPORD, or FRAGO), the platoon leader develops a tentative plan. The process of developing this plan in a time-constrained environment usually has four steps: mission analysis, course of action development, course of action analysis, and course of action selection. Typically, a platoon leader will develop one course of action (COA). If more time is available, he may develop more than one COA; however, these will be limited in nature. If he develops more than one COA, he will then need to compare these COAs and select the one that best accomplishes his assigned purpose.

a. **Mission Analysis.** This is a continuous process during the course of the operation. It requires the platoon leader to analyze all the factors of METT-TC in as much depth as time and quality of information will allow. The factors of METT-TC are not always analyzed sequentially. How and when the platoon leader analyzes each factor depends on when information is made available to him. One technique for the analysis is based on the sequence of products that the company commander receives and produces: *mission, terrain and weather, enemy, troops, time* and *civil considerations*. As a result of this analysis, the platoon leader must develop significant conclusions about how each element will affect mission accomplishment

(1) **Analysis of Mission.** Leaders at every echelon must have a clear understanding of the mission, intent, and concept of the operation of the commanders one and two levels higher. Without this understanding, it would be difficult to exercise disciplined initiative. One technique to quickly understand the operation is to draw a simple sketch of the battalion and company's concepts of the operation (if not provided by the commander). The platoon leader can now understand how his platoon is nested into the overall plan, and can now capture this understanding in his restated mission statement. The platoon leader will write a restated mission statement using his analyses of these areas: the battalion mission, intent and concept; the company mission, intent and concept; identification of specified, implied, and essential tasks; identification of risks; and any constraints.

(a) **Battalion Mission, Intent and Concept.** The platoon leader must understand the battalion commander's concept of the operation. He identifies the battalion's task and purpose, and how his company is contributing to the battalion's fight. The platoon leader must also understand the battalion commander's intent found in the friendly forces paragraph (paragraph 1b) of the company order.

(b) **Company Mission, Intent and Concept.** The platoon leader must understand the company's concept of the operation. He identifies the company's task and purpose, as well as his contribution to the company's fight. The platoon leader must clearly understand the commander's intent from the order. Additionally, the platoon leader identifies the task, purpose, and disposition for all adjacent maneuver elements under company control.

(c) **Platoon Mission.** The platoon leader finds his platoon mission in the company's concept of the operation paragraph. The purpose of the main effort platoon usually matches the purpose of the company. Similarly, supporting effort platoons' purposes must relate directly to the purpose of the main effort platoon. The platoon leader must understand how his purpose relates to the other platoons in the company. He determines

the platoon's essential tactical task to successfully accomplish his given purpose. Finally, he must understand why the commander gave his platoon a particular tactical task and how it fits into the company's concept of the operation.

(d) *Constraints*. Constraints are restrictions placed on the platoon leader by the commander to dictate action or inaction, thus restricting the freedom of action the platoon leader has for planning by stating the things that must or must not be done. The platoon leader identifies all of the constraints the commander places on the unit's ability to execute its mission. The two types of constraints are: requirements for action (for example, maintain a squad in reserve) and prohibitions of action (for example, do not cross PL BULL until authorized).

(e) *Identification of Tasks*. The platoon leader must identify and understand the tasks required to accomplish the mission. There are three types of tasks: specified, implied and essential.

- **Specified Tasks**. These are tasks specifically assigned to a platoon by the commander. Paragraphs 2 and 3 from the company OPORD primarily state specified tasks. Specified tasks may also be found paragraphs 4 and 5, and in annexes and overlays.
- **Implied Tasks**. These are tasks that must be performed to accomplish a specified task, but which are not stated in the OPORD. Implied tasks are derived from a detailed analysis of the OPORD, the enemy situation, the courses of action, and the terrain. Analysis of the platoon's current location in relation to future areas of operation as well as the doctrinal requirements for each specified task also might provide implied tasks. SOP tasks are not considered implied tasks.
- **Essential Task**. An essential task is one that must be executed to accomplish the mission derived from a review of the specified and implied tasks.

(f) *Identification of Risks*. Risk is the chance of injury or death for individuals and damage to or loss of vehicles and equipment. Risk, or the potential for risk, is always present in every combat and training situation the platoon faces. Risk management must take place at all levels of the chain of command during every operation; it is an integral part of tactical planning. The platoon leader, his NCOs, and all other platoon soldiers must know how to use risk management, coupled with fratricide avoidance measures, to ensure that the mission is executed in the safest possible environment within mission constraints. (Refer to Appendix C for a detailed discussion of risk management and Appendix D for a detailed discussion of fratricide avoidance.)

(g) *Restated Platoon Mission Statement*. The platoon leader restates his mission statement (Figure 2-3) using the five W's: who, what, when, where, and why. The "who" is the platoon. The "what" is the type of operation and the platoon's essential tactical task. The "when" is given in the order. The "where" is the objective or location taken from the order. The "why" is the purpose for the platoon's essential tactical task taken from the commander's concept of the operations paragraph.

3rd Platoon (Who performs the task?) attacks to seize (What is the task?) the bridge at NX330159 (Where do they perform the task?) at 040600Z FEB 02 (When do they perform the task?) to pass the 1st Platoon (company main effort) on to OBJ BOB (Why must they perform the task?).

Figure 2-3. Example mission statement.

(2) ***Analysis of Terrain and Weather.*** The platoon leader will receive a detailed terrain analysis from the company team commander; however, he must conduct a detailed analysis of the terrain to determine how it will uniquely affect his unit and the enemy he anticipates fighting. The platoon leader must gain an appreciation of the terrain before attempting to develop either enemy or friendly COA. He must not merely make observations (or example, this is high ground, this is an avenue of approach); he must arrive at significant conclusions about how the ground will affect the enemy as well as his unit. Because of guidance from the commander and limited planning time, the platoon leader normally prioritizes his terrain analysis. For example, in the conduct of an assault, his priority may be the area around the objective followed by the platoon's specific axis leading to the objective.

(a) Terrain mobility is classified in one of three categories.

- Unrestricted. This is terrain free of any movement restrictions; no actions are required to enhance mobility. For mechanized forces, unrestricted terrain is typically flat or moderately sloped, with scattered or widely spaced obstacles such as trees or rocks. Unrestricted terrain generally allows wide maneuver and offers unlimited travel over well-developed road networks. Unrestricted terrain is an advantage in situations requiring rapid movement.
- Restricted. This terrain hinders movement to some degree, and units may need to detour frequently. Restricted terrain may cause difficulty in maintaining optimal speed, moving in some types of combat formations, or transitioning from one formation to another. This terrain typically encompasses moderate to steep slopes or moderate to dense spacing of obstacles such as trees, rocks, or buildings. The terrain may not require additional assets or time to traverse, but it may hinder movement to some degree due of increased security requirements. In instances when security is the paramount concern, both friendly and enemy elements may move in more restricted terrain that may provide more cover and concealment.
- Severely Restricted. This terrain severely hinders or slows movement in combat formations unless some effort is made to enhance mobility. It may require a commitment of engineer forces to improve mobility, or a deviation from doctrinal tactics, such as using a column rather than a wedge formation or moving at speeds much slower than otherwise preferred. Severely restricted terrain includes any terrain that requires equipment not organic to the unit to cross (for example, a large body of water and slopes requiring mountaineering equipment).

(b) The platoon leader uses the military aspects of terrain to analyze the ground. The military aspects of terrain include observation and fields of fire, avenues of approach, key terrain, obstacles, and cover and concealment (Figure 2-4, page 2-10). The sequence used to analyze the military aspects of terrain can vary. The leader may prefer to determine *obstacles* first, *avenues of approach* second, *key terrain* third, *observation and fields of fire* fourth, and *cover and concealment* last. The platoon leader determines the effect of each military aspect of terrain on both enemy and friendly forces, and applies his conclusions to the enemy or friendly course of action.

OCOKA
Observation Fields of Fire
Cover and Concealment
Obstacles
Key Terrain
Avenues of Approach

Figure 2-4. Military aspects of terrain.

- **Obstacles.** The platoon leader first identifies existing and reinforcing obstacles in his AO that limit his mobility with regards to the mission. Existing obstacles are typically natural terrain features present on the battlefield and may include: ravines; gaps, or ditches over 3 meters wide; tree stumps and large rocks over 18 inches high; forests with trees 8 inches or greater in diameter and with less than 4 meters between tree; and man-made obstacles such as towns or cities. Reinforcing obstacles are typically man-made obstacles that augment existing obstacles. These may include minefields, antitank ditches, road craters, abatis and log cribs, wire obstacles, and infantry strongpoints. Figure 2-5 lists several offensive and defensive considerations the platoon leader can include in his analysis of obstacles and restricted terrain.

OFFENSIVE CONSIDERATIONS

- How is the enemy using obstacles and restricted terrain features?
- What is the composition of the enemy's reinforcing obstacles?
- How will obstacles and terrain affect my movement and or maneuver?
- If necessary, how can the platoon avoid such features?
- How do we detect and, if desired, bypass the obstacles?
- Where has the enemy positioned weapons to cover the obstacles, and what type of weapons is he using?
- If I must support or execute a breach, where is the expected breach site?

DEFENSIVE CONSIDERATIONS

- Where does the enemy want to go? Where can I kill the enemy? How do I get him to go there?
- How will existing obstacles and restricted terrain affect the enemy?
- How can I use these features to force the enemy into my engagement area, deny him an avenue, or disrupt his movement?

Figure 2-5. Considerations in obstacle and terrain analysis.

- **Avenues of Approach.** An avenue of approach is an air or ground route of an attacking force leading to its objective or to key terrain. For each avenue of approach, the platoon leader determines the type (mounted, dismounted, air, or subterranean), size, and formation and speed of the largest unit that can travel along it, or the commander may give him this information. Mounted forces may move on avenues along unrestricted or restricted terrain (or both).

Dismounted avenues and avenues used by reconnaissance elements normally include terrain that is restricted and, at times, severely restricted to mounted forces. The terrain analysis also must identify avenues of approach for both friendly and enemy units. Figure 2-6 lists several considerations for avenue of approach analysis.

<p>OFFENSIVE CONSIDERATIONS</p> <ul style="list-style-type: none">• How can I use each avenue of approach to support my movement and or maneuver?• How will each avenue support movement techniques, formations, and (once we make enemy contact) maneuver?• Will variations in trafficability or lane width force changes in formations or movement techniques or require defile drills?• What are the advantages and/or disadvantages of each avenue?• What are the enemy's likely counterattack routes?• Do lateral routes exist that we can use to shift to other axes or that the enemy can use to threaten our flanks? <p>DEFENSIVE CONSIDERATIONS</p> <ul style="list-style-type: none">• What are all likely enemy avenues into my sector?• How can the enemy use each avenue of approach?• Do lateral routes exist that the enemy can use to threaten our flanks?• What avenues would support a friendly counterattack?
--

Figure 2-6. Considerations in avenue of approach analysis.

- **Key Terrain.** Key terrain affords a marked advantage to the combatant who seizes, retains, or controls it. If not provided by the company team commander, the platoon leader identifies key terrain starting at the objective/main battle area and working backwards to his current position. It is a conclusion rather than an observation. The platoon leader must assess what terrain is key to accomplishing his mission. Key terrain may allow the platoon leader to apply direct fire or achieve observation of the objective (or avenue of approach).
 - An example of key terrain for a platoon could be a tree line on a hillside that provides overwatch of a high-speed avenue of approach. Controlling this tree line may be critical in passing follow-on forces (main effort) to their objective. High ground is not necessarily key terrain. For example, a prominent hilltop overlooks an avenue of approach and offers clear observation and fields of fire, but if it is easily bypassed and offers nothing to the enemy, it is not key terrain.
 - Although unlikely, the platoon leader may identify decisive terrain--key terrain that holds such importance that the seizure, retention, and control of it will be necessary for mission accomplishment and may decide the outcome of the battle. A technique for evaluating key terrain is to analyze the following two military aspects of terrain (observation and fields of fire, and cover and concealment) to each piece of key terrain. Figure 2-7, page

2-12) depicts operational considerations to use when analyzing key terrain.

OPERATIONAL CONSIDERATIONS

- What terrain is important for observation, for command and control, and for calling for fires?
- What terrain is important to the enemy and why? Is it important to me?
- What terrain is key to the platoon and to the company and why? Is it important to the enemy?
- Is the enemy controlling this key terrain? Am I controlling this key terrain?
- How do I gain or maintain control of key terrain?

Figure 2-7. Considerations in key terrain analysis.

- **Observation and Fields of Fire.** The platoon leader analyzes areas surrounding key terrain, objectives, avenues of approach, and obstacles to determine if they provide clear observation and fields of fire for both friendly and enemy forces. He locates intervisibility (IV) lines (terrain that inhibits observation from one point to another) that have not been identified by the commander and determines where visual contact between the two forces occurs. When analyzing fields of fire, the platoon leader focuses on both friendly and enemy direct fire capabilities. Additionally, he identifies positions that enable artillery observers to call for indirect fires and permit snipers to engage targets. Figure 2-8 provides considerations for analysis of observation and fields of fire. Whenever possible, the platoon leader conducts a ground reconnaissance from both the friendly and enemy perspective.

OFFENSIVE CONSIDERATIONS

- Are clear observation and fields of fire available on or near the objective for enemy observers and weapon systems?
- Where can the enemy concentrate fires?
- Where is he vulnerable?
- Where are possible SBF or ABF positions for friendly forces.
- Where are the natural TRPs?
- Where do I position indirect fire observers?

DEFENSIVE CONSIDERATIONS

- What locations afford clear observation and fields of fire along enemy avenues of approach?
- Where will the enemy set firing lines and or antitank weapons?
- Where will I be unable to mass fires?
- Where is the dead space in my sector? Where am I vulnerable?
- Where are the natural TRPs?
- Where do I position indirect fire observers?

Figure 2-8. Considerations in analysis of observation and fields of fire.

- **Cover and Concealment.** Cover is protection from the effects of fires. Concealment is protection from observation, but not direct fire or indirect fires. Figure 2-9 provides considerations for analysis of cover and concealment. Consideration of these elements leads the platoon leader to identify areas that can, at best, achieve both facets. The platoon leader looks at the terrain, foliage, structures, and other features on the key terrain, objective, and avenues of approach to identify sites that offer cover and concealment.

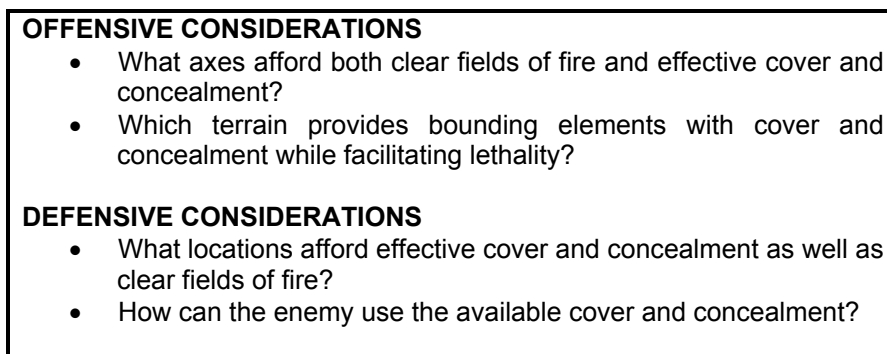

Figure 2-9. Considerations in analysis of cover and concealment.

(c) There are five military aspects of weather (Figure 2-10). The platoon leader must go beyond merely making observations; he must arrive at significant conclusions about how the weather will affect the visibility, mobility, and survivability of his platoon and of the enemy. He receives conclusions from the commander and identifies his own critical conclusions about the five military aspects of weather. Most importantly, the platoon leader must apply these conclusions when he develops friendly and enemy COAs.

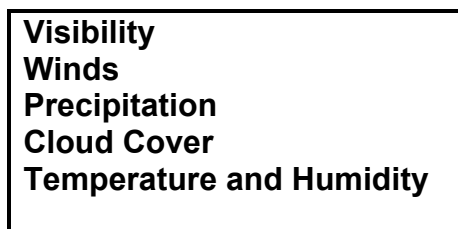

Figure 2-10. Military aspects of weather.

- **Visibility.** The platoon leader identifies critical conclusions about visibility factors (such as light data, fog, and smog) and battlefield obscurants (such as smoke and dust). Some visibility considerations are:
 - **Light Data.** The platoon leader identifies critical conclusions about beginning morning nautical twilight (BMNT), sunrise, sunset, end of evening nautical twilight (EENT), moonrise, moonset, and percentage of illumination. Some light data considerations are:
 - Will the sun rise behind my attack? Will I attack toward the sunrise?

- How can I take advantage of the limited illumination?
- How will this effect friendly and enemy target acquisition?
- Will the current weather favor the use of smoke to obscure during breaching?
- Will fog affect friendly and enemy target acquisition?
- Winds. The platoon leader identifies critical conclusions about wind factors (such as direction and speed) Some wind considerations are:
 - Will wind speed cause smoke to dissipate quickly?
 - Will wind speed and direction favor enemy use of smoke?
- Precipitation. The platoon leader identifies critical conclusions about precipitation factors (such as type, amount, and duration). Some precipitation considerations are:
 - How will precipitation affect mobility?
 - How can precipitation add to the platoon achieving surprise?
- Cloud Cover. The platoon leader identifies critical conclusions about cloud cover (such as limits on illumination and solar heating of targets).
 - How will cloud cover effect platoon operations at night? How will it affect the enemy?
 - How will cloud cover effect the target acquisition of thermal sights?
- Temperature and Humidity. The platoon leader identifies critical conclusions about temperature factors (such as high and low temperatures, and infrared crossover times) and battlefield factors (such as use of smoke or chemicals). Some temperature considerations are:
 - How will temperature (hot or cold) and humidity affect the dismounted rate of march for the platoon?
 - How will temperature (hot or cold) and humidity affect the soldiers and equipment?
 - Will temperatures and humidity favor the use of nonpersistent chemicals?

(3) ***Analysis of Enemy.*** This step allows the platoon leader to identify the enemy's strength and potential weaknesses or vulnerabilities so that he can exploit them to generate overwhelming combat power in achieving his mission. The platoon leader must understand the assumptions the commander used to portray the enemy's COAs covered in the company's plan. Furthermore, the platoon leader's assumptions about the enemy must be consistent with those of the company commander. To effectively analyze the enemy, the platoon leader must know how the enemy may fight. It is equally important for the platoon leader to understand what is actually known about the enemy as opposed to what was assumed or templated. During doctrinal analysis, to know only the number and types of vehicles, soldiers, and weapons the enemy has is not enough. The platoon leader's analysis must extend down to the squad level. During offensive, defensive, or stability operations within a smaller-scale contingency in an underdeveloped area where little is known about the combatants, it may be difficult to doctrinally portray or template the enemy. In this case, the platoon leader must rely on brigade and battalion analyses funneled through the company commander as well as his own knowledge of recent enemy activities. The platoon leader should consider the following areas as he analyzes

the enemy: order of battle (composition, disposition, and strength), capabilities, and courses of action.

(a) *Composition*. The platoon leader's analysis must determine the number and types of threat vehicles, soldiers, and equipment that could be used against his platoon. He gets this information from paragraph 1a of the company team order or intelligence updates. His analysis must also examine how the enemy organizes for combat to include the possible use of a reserve.

(b) *Disposition*. From the commander's information, the platoon leader identifies how the enemy, that his platoon will fight, is arrayed. Much of this information is gained through a detailed company OPORD and intelligence updates.

(c) *Strength*. The platoon leader identifies the strength of the enemy. It is imperative that the platoon leader determines the actual numbers of equipment and personnel that his platoon is expected to fight or that may affect his platoon. Again, much of this information is gained through a detailed OPORD and intelligence updates.

(d) *Capabilities*. Based on the commander's assessment, and the enemy's doctrine and current location, the platoon leader must determine what the enemy is capable of doing against his platoon during the mission. Such an analysis must include the planning ranges for each threat weapon system that the platoon may encounter.

(e) *Enemy Courses of Action*. To identify potential enemy COAs, the platoon leader weighs the result of his initial analysis of terrain and weather against the enemy's composition, capabilities, and doctrinal objectives, then uses this, if necessary, to refine his commander's situational template (SITTEMP). The end product is a platoon visual or graphic depiction of how he believes the enemy will fight under the specific conditions expected on the battlefield. Much of this information will be gained from the commander's analysis and intelligence updates.

- Included in this depiction is the range fan of the enemy's weapons and any tactical and protective obstacles, either identified or merely templated. After the platoon leader briefs the enemy analysis to his subordinates, he must ensure they understand what is known, what is suspected, and what is merely templated (educated guess). The platoon leader's visual or graphic depiction of the enemy may show the commander's SITTEMP in a different manner or depict individual soldier and weapons positions, a refinement of the commander's SITTEMP.
- In conjunction with his visual or graphic depiction of the enemy, the platoon leader considers the factors of METT-TC from the enemy's perspective to develop the details of possible enemy COAs. The following points can assist in this process:
 - Understand the enemy's mission. What will the enemy's likely mission be based on threat doctrine and knowledge of the situation, and the enemy's capabilities? This may be difficult to determine if the enemy has no established order of battle. Enemy analysis must consider situational reports of enemy patterns and intelligence updates. When does the enemy strike, and where? Where does the enemy get logistical support and fire support? What cultural or religious factors are involved?
 - Why is the enemy conducting this operation?
 - What are the enemy's goals?

- What are the enemy’s capabilities?
- What are the enemy’s objectives? Based on the commander’s SITTEMP and the projected threat mission, what are the enemy’s march objectives (offense) or the terrain or force he intends to protect (defense)? The commander normally provides this information.
- Terrain and weather. If the enemy is attacking, which avenues will he use to reach his objectives in executing his COAs, and why?
- How will terrain affect his speed and formations?
- How will he use key terrain and locations with clear observation and fields of fire?
- Does the weather aid or hinder the enemy in accomplishing his mission or does the weather degrade the enemy’s weapons or equipment effectiveness?
- Enemy obstacles. Known locations give the platoon leader insights into how the enemy is trying to accomplish his mission.

(4) **Analysis of Troops.** Perhaps the most critical aspect of mission analysis is determining the combat power potential of one’s force. The platoon leader must realistically and unemotionally determine what tasks his soldiers are capable of performing. This includes the troops who are either attached to or in direct support of the platoon. The platoon leader must know the status of his soldiers’ experience and training level, and the strengths and weaknesses of his subordinate leaders. The assessment includes knowing the status of his soldiers and their equipment. It includes understanding the full array of assets that are in support of the platoon. For example, how much indirect fire is available and when is it available? For M2A3-equipped units, this information is gained from FBCB2.

(5) **Analysis of Time.** As addressed during “receive the mission”, time analysis is a critical aspect to planning, preparation and execution. Not only must the platoon leader appreciate how much time is available, he must be able to appreciate the time-space aspects of preparing, moving, fighting, and sustaining. He must be able to see his own tasks and enemy actions in relation to time (Figure 2-11).

(a) He must be able to assess the impact of limited visibility conditions on the troop leading procedures.

(b) He must know how long it takes to conduct certain tasks such as order preparation, rehearsals, back-briefs, and other time-sensitive preparations for subordinate elements.

(c) He must understand how long it takes to deploy a support by fire element, probably the weapons squad (maybe the mounted element), and determine the amount of ammunition needed to sustain the support for a specific period of time.

(d) He must know how long it takes to assemble a bangalore torpedo and to breach a wire obstacle.

(e) Most importantly, as events occur the platoon leader must adjust his analysis of time available to him, and assess the impact on what he wants to accomplish.

(f) Finally, he must update previous timelines for his subordinates listing all events that affect the platoon.

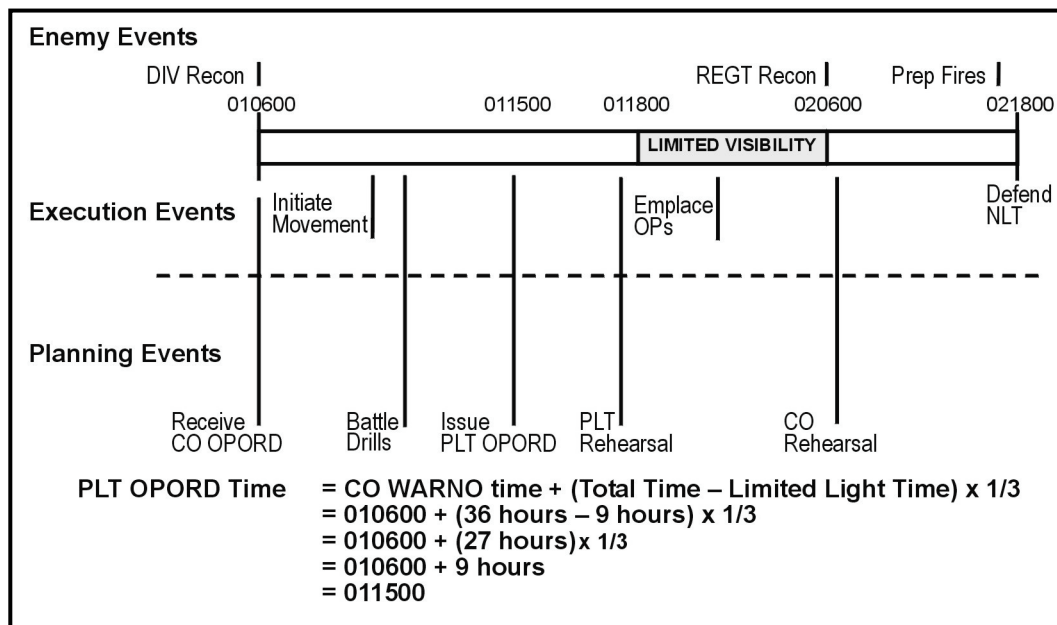

Figure 2-11. Example platoon timeline.

(6) **Analysis of Civil Considerations.** The commander will provide the platoon leader with civil considerations that may affect the company and platoon missions. The platoon leader must also identify any civil considerations that may only affect his platoon mission. These may include refugee movement, humanitarian assistance requirements, or specific requirements related to the rules of engagement (ROE) or rules of interaction (ROI).

(7) **Summary of Mission Analysis.** The end result of mission analysis, as done during the formulation of a tentative plan, is a number of insights and conclusions regarding how the factors of METT-TC affect accomplishment of the platoon's mission. From these the platoon leader will develop a COA.

b. **Course of Action Development.** The purpose of COA development is to determine one (or more) way(s) to achieve the mission by applying the overwhelming effects of combat power at the decisive place or time with the least cost in friendly casualties. IF time permits, the platoon leader may develop several COAs. The platoon leader makes each COA as detailed as possible to clearly describe how he plans to use his forces to achieve the unit's mission-essential task(s) and purpose consistent with the commander's intent. He focuses on the actions the unit must take at the decisive point and works backward to his start point. A COA should satisfy the criteria listed in Table 2-2 (page 2-18).

Suitable	If the COA were successfully executed, would the unit accomplish the mission consistent with the battalion commander's concept and intent?
Feasible	The platoon must have the technical and tactical skill and resources to successfully accomplish the COA. In short, given the enemy situation and terrain, the unit must have the training, equipment, leadership, and rehearsal time necessary to successfully execute the mission.
Distinguishable	<i>If more than one COA is developed</i> , then each COA must be sufficiently different from the others to justify full development and consideration. At platoon level, this is very difficult to accomplish, particularly if the platoon has limited freedom of action.
Acceptable	The COA minimizes friendly casualties and positions the platoon for future operations.
Complete	The COA must include the operational factors of who, what, when, where, and how. The COA must address the doctrinal aspects of the operation. For example, in the attack against a defending enemy, the COA must cover movement to, deployment against, assault of, and consolidation upon the objective.

Table 2-2. Course of action criteria.

(1) **COA Development Step 1. Analyze Relative Combat Power.** This step compares combat power strengths and weaknesses of both friendly and enemy forces. At the platoon level this should not be a complex process. However, if the platoon is attacking or defending against a force in a situation where the enemy has no order of battle but has exhibited guerrilla or terrorist type tactics, it could be difficult. For the platoon leader, it starts by returning to the conclusions the commander arrived at during mission analysis, specifically the conclusions about the enemy's strength, weakness, and vulnerabilities. In short, the platoon leader is trying to see where, when, and how the effects of the platoon's combat power (maneuver, firepower, protection, leadership and information) can be superior to the enemy's while achieving the mission. This analysis should lead to techniques, procedures, and a potential decisive point that will focus the COA development. (See FM 101-5-1 for the definition of a decisive point.)

(2) **COA Development Step 2. Generate Options.** As the platoon leader begins to develop a COA, he should consider, if he has not done so in mission analysis, what doctrine suggests in terms of accomplishing the mission. For example, in an attack of a strongpoint, doctrine outlines several steps: isolate the objective area and the selected breach site, attack to penetrate and seize a foothold in the strongpoint, exploit the penetration, and clear the objective. In this case, doctrine gives the platoon leader a framework to begin developing a way to accomplish the mission.

(a) The next and most important action is to identify a decisive point in order to progress with COA development. The decisive point may be given to the platoon leader by the company commander or determined by the platoon leader through his relative combat power analysis.

(b) The platoon leader then determines the main effort's purpose. The main effort's purpose is nested to the platoon's purpose and is achieved at the platoon leader's decisive point.

(c) The platoon leader next identifies the supporting efforts' purposes. The supporting efforts' purposes are nested to the main effort's purpose by setting the conditions for success of the main effort.

(d) The platoon leader then specifies the essential tactical tasks that will enable the main and supporting efforts to achieve their purpose.

(3) **COA Development Step 3. Array Initial Forces.** The platoon leader must then determine the specific number of squads and weapons necessary to accomplish the mission and provide a basis for development of a scheme of maneuver. He will consider the platoon's restated mission statement, the commander's intent, and the enemy's most probable COA. He should allocate resources to the main effort (at the decisive point) and continue with supporting efforts in descending order of importance to accomplish the tasks and purposes he assigned during Step 2. For example, the main effort in an attack of a strong point may require a rifle squad and an engineer squad to secure a foothold, whereas a support by fire force may require an entire squad and the fires from the vehicles to isolate the objective.

(4) **COA Development Step 4. Develop Schemes of Maneuver.** The scheme of maneuver is a description of how the platoon leader envisions his subordinates will accomplish the mission from the start of the operation until its completion. He does this by determining how the achievement of one task will lead to the execution of the next. He clarifies in his mind the best ways to use the available terrain as well as how best to employ the platoon's strengths against the enemy's weaknesses (gained from his relative combat power analysis). This includes the requirements of indirect fire to support the maneuver. The platoon leader then develops the maneuver control measures necessary to enhance understanding of the scheme of maneuver, ensure fratricide avoidance, and to clarify the task and purpose of the main and supporting efforts. (Refer to Appendix D for a detailed discussion of fratricide avoidance.) He also determines the supply and casualty evacuation aspects of the COA.

(5) **COA Development Step 5. Assign Headquarters.** The platoon leader assigns specific elements (for example, squads) as the main and supporting efforts. The platoon leader ensures that he has employed every element of the unit and has C2 for each element.

(6) **COA Development Step 6. Prepare COA Statements and Sketches.** The platoon leader's ability to prepare COA sketches and statements will depend on the amount of time available and his skill and experience as a platoon leader. Whenever possible, the platoon leader should prepare a sketch showing the COA. The COA statement is based on the scheme of maneuver the commander has already developed. It focuses on all significant actions from the start of the COA to its finish. The company team commander must provide his analysis because the platoon and squad leaders have the least amount of time and experience to conduct COA development.

c. **Analysis of COA.** After developing a COA, the platoon leader analyzes it to determine its advantages and disadvantages, to visualize the flow of the battle, and to identify requirements to synchronize actual execution. Typically this is done mentally or during a discussion with the platoon sergeant, squad leaders, or other key personnel. This

technique is not complicated, and it facilitates a total understanding of the plan. This is not a rehearsal.

d. **COA Comparison and Selection.** If the platoon leader develops more than one COA, he must compare them by weighing the specific advantages, disadvantages, strengths, and weaknesses of each. These attributes may pertain to the accomplishment of the platoon purpose, the use of terrain, the destruction of the enemy, or any other aspect of the operation that the platoon leader believes is important. The platoon leader uses these factors as his frame of reference in tentatively selecting the best COA. He makes the final selection of a COA based on his own analysis.

2-8. INITIATE MOVEMENT

The platoon leader initiates any movement that is necessary to continue preparations or to posture the unit for the operation. This may include movement to an assembly area, battle position, perimeter defense, or attack position; movement of reconnaissance elements; or movement to compute time-distance factors for the unit's mission.

2-9. CONDUCT RECONNAISSANCE

Even if the platoon leader has made a leader's reconnaissance with the company team commander at some point during TLP, he should still conduct a reconnaissance after he has developed his plan. The focus of the reconnaissance is to confirm his tentative plan.

NOTE: The amount or type of reconnaissance conducted must be evaluated by the amount of information needed, the risk to leaders conducting the reconnaissance, and time available, and must be a coordinated effort with higher command.

a. His tentative plan may include assumptions or critical facts concerning the enemy's location (templated positions) and strength or assumptions about the terrain (to verify, for example, that a tentative support by fire position actually will allow for suppression of the enemy, or to verify the utility of an avenue of approach).

b. The platoon leader may include his subordinate leaders in this reconnaissance (or instructs a squad to conduct a reconnaissance patrol with specific objectives). This allows them to see as much of the terrain and enemy as possible. It also helps each leader visualize the plan more clearly.

c. At the platoon level, the leader's reconnaissance may include movement to or beyond an LD or from the forward edge of the battle area (FEBA) back to and through the engagement area along likely enemy routes. If possible, the platoon leader should select a vantage point that provides the group with the best possible view of the decisive point.

d. In addition to the information available to a M2A3-equipped platoon via FBCB2, the platoon leader may also conduct a leader's reconnaissance. Examples of this type of reconnaissance include surveillance of an area by subordinate elements, patrols by infantry squads to determine where the enemy is (and is not) located, and establishment of OPs to gain additional information. The nature of the reconnaissance, including what it covers and how long it lasts, depends on the tactical situation and the time available. The

platoon leader should use the results from the COA development process to identify information and security requirements for the platoon's reconnaissance operations.

2-10. COMPLETE THE PLAN

Completion of the plan includes several actions that transform the commander's intent and concept and the platoon concept into a fully developed platoon OPORD. These actions include preparing overlays, refining the indirect fire list, completing combat service support (CSS) and C2 requirements, as well as updating the tentative plan as a result of the reconnaissance or information updates. It also allows the platoon leader to prepare the briefing site, briefing medium, and briefing material he will need to present the OPORD to his subordinates. Completing the plan allows the platoon leader to make final coordination with other units or the commander before issuing the OPORD to his subordinates.

2-11. ISSUE THE OPERATIONS ORDER

The OPORD precisely and concisely explains the platoon leader's intent and concept of how he wants the three squads and two mounted sections to accomplish the mission. The OPORD must not contain unnecessary information that could obscure what is essential and important. The platoon leader must ensure his squads and sections know exactly what must be done, when it must be done, and how the platoon must work together to accomplish the mission and stay consistent with the intentions of the commander.

a. Whenever possible, the platoon leader issues the order in person, looking into the eyes of all his soldiers to ensure each leader and soldier understands the mission and what his element must achieve. The platoon leader also uses visual aids, such as sand tables and concept sketches, to depict actions on the objective or movement.

b. The format of the five-paragraph OPORD helps the platoon leader paint a complete picture of all aspects of the operation: terrain, enemy, higher and adjacent friendly units, platoon mission, execution, support, and command. The format also helps him address all relevant details of the operation. Finally, it provides subordinates with a predictable, smooth flow of information from beginning to end.

NOTE: In M2A3-equipped units, the platoon leader may issue the platoon OPORD via FBCB2. This allows for quick dissemination of information and graphics. However, the platoon leader lacks the human contact that allows him to feel comfortable that his subordinates clearly understand the plan. Some combination of personal interaction and the FBCB2 is the best solution.

2-12. SUPERVISE AND REFINE

The platoon leader supervises the unit's preparation for combat by conducting confirmation briefs, rehearsals, and inspections.

a. Platoon leaders should conduct a confirmation brief after issuing the oral OPORD to ensure subordinates know the mission, the commander's intent, the concept of the operation, and their assigned tasks. Confirmation briefs can be conducted face to face, by radio, or by FBCB2 (if so equipped), depending on the situation. Face to face is the desired method, because all section and squad leaders are together to resolve questions, and it ensures that each leader knows what the adjacent squad or vehicle is doing.

b. If time permits, the platoon conducts full rehearsals. During the rehearsals, leaders practice sending tactical reports in accordance with the unit's SOP. Reporting before, during, and after contact with the enemy is rehearsed in detail starting with actions on the objective. Rehearsals are not intended to analyze a COA.

(1) The platoon leader uses well-planned, efficiently run rehearsals to accomplish the following:

- Reinforce training and increase proficiency in critical tasks.
- Reveal weaknesses or problems in the plan.
- Integrate the actions of attached elements.
- Confirm coordination requirements between the platoon and adjacent units.
- Improve each soldier's understanding of the concept of the operation, the direct fire plan, anticipated contingencies, and possible actions and reactions for various situations that may arise during the operation.

(2) Rehearsal techniques include:

(a) *Map Rehearsal*. A map rehearsal is usually conducted as part of a confirmation brief involving subordinate leaders or portions of their elements. The leader uses the map and overlay to guide participants as they brief their role in the operation. If necessary, he can use a sketch map. A sketch map provides the same information as a terrain model and can be used at any time.

(b) *Sand Table or Terrain Model*. This reduced-force or full-force technique employs a small-scale sand table or model that depicts graphic control measures and important terrain features for reference and orientation. Participants walk or move "micro" armor around the sand table or model to practice the actions of their own elements or vehicles in relation to other members of the platoon.

(c) *Radio/Tactical Internet (Digital) Rehearsal*. This is a reduced-force or full-force rehearsal conducted when the situation does not allow the platoon to gather at one location. Subordinate elements check their communications systems and rehearse key elements of the platoon plan.

(d) *Reduced-Force Rehearsal*. In this rehearsal, leaders discuss the mission while moving over key terrain or similar terrain in vehicles or dismounted.

(e) *Full-Force Mounted and Dismounted Rehearsal*. This is used during a full-force rehearsal. Rehearsals begin in good visibility over open terrain then become increasingly realistic until conditions approximate those expected in the area of operations.

NOTE: Time permitting, the platoon should conduct a full-force mounted and dismounted rehearsal of the plan. M2A3-equipped units would also rehearse the radio or digital reports required during execution.

CHAPTER 3

TACTICAL MOVEMENT

Leaders move units tactically to prepare them for contact. Each movement technique and formation has unique advantages and disadvantages. Some offer security, but take longer; others offer speed, but less security. Each works better in certain types of terrain or tactical situations than it would in others. This chapter focuses on mechanized infantry rifle platoon and squad mounted and dismounted movement techniques, formations, and actions, and the platoon leader's options for moving the platoon tactically.

3-1. MOUNTED MOVEMENT FORMATIONS

The platoon leader uses formations for several purposes: to relate one vehicle or squad to another on the ground, to position firepower to support the direct-fire plan, to establish responsibilities for sector security among vehicles or squads, or to aid in the execution of battle drills and directed COAs. Just as they do with movement techniques, platoon leaders plan formations based on where they expect enemy contact and on the higher commander's plans to react to contact. The platoon leader evaluates the situation and decides which formation best suits the mission and situation.

a. **Choices.** The platoon need not use the same formation as the company team unless directed by the company commander. However, the platoon leader must coordinate his formation with other elements moving in the main body team's formation.

b. **Factors.** Sometimes, platoon and company team formations differ due to METT-TC factors. For example, the platoons could move in wedge formations within a company team vee.

(1) In planning and executing movement, leaders must consider the fluidity of formations. Spacing requirements, as well as other METT-TC considerations, require the platoon to adapt basic formations. Leaders must stay ready to adjust the distance of individual vehicles based on terrain, visibility, and mission requirements.

(2) The platoon usually moves in formation when using traveling or traveling overwatch. When it uses bounding overwatch, the bounding element makes the best use of the terrain, rather than adopting a precise formation. Only in this way can it move effectively while maintaining adequate security.

NOTE: This chapter includes example formations only. These examples do not take into account terrain and other METT-TC factors, even though METT-TC factors play the most crucial role in selecting and executing a formation. Leaders must plan to adapt their choice of formation to the specific situation.

c. **Mounted Formations.** When mounted, the platoon uses the column, wedge, line, echelon, coil, and herringbone formations (based on METT-TC factors).

(1) **Column Formation.** The platoon uses the column when moving fast, when moving through restricted terrain on a specific route, or when it does not expect enemy contact. Each vehicle normally follows directly behind the vehicle in front of it. However, if the situation dictates, vehicles can disperse laterally to enhance security. This

is sometimes referred to as a staggered column. Figure 3-1 shows this type of column movement. The column formation has the following characteristics, advantages, and limitations:

- Control—Easy.
- Fires:
 - Front and rear—Limited.
 - Flank—Excellent.
- Security—Limited, overall.

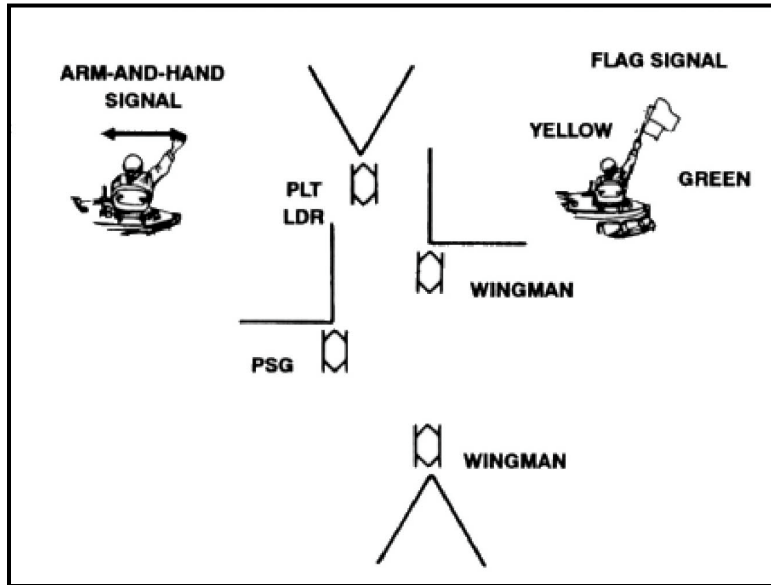

Figure 3-1. Column formation with dispersal for added security (staggered column).

(2) **Wedge Formation.** When the enemy situation seems unclear or when contact might occur, leaders often use the wedge formation shown in Figure 3-2. Both the platoon leader and platoon sergeant stay in the center of the formation, with their wingmen located to the rear of and outside of them. The wedge has the following characteristics, advantages, and limitations:

- Control—Easy.
- Fires:
 - Front—Excellent.
 - Flanks—Good.
- Security—Good, to flanks.

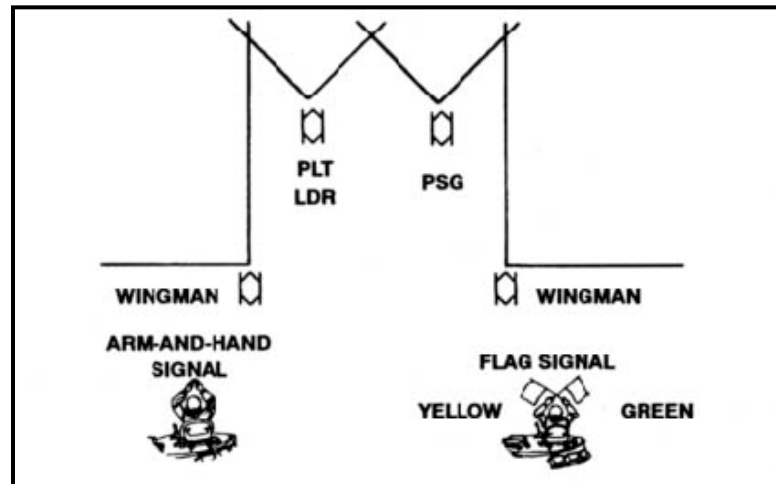

Figure 3-2. Wedge formation.

(3) **Line Formation.** When assaulting a weakly defended objective, crossing open areas, or occupying a support-by-fire position, the platoon mainly uses the line formation (Figure 3-3). The platoon can use the line formation in the assault to maximize the platoon's firepower and shock effect. The platoon normally uses the line formation when no terrain remains between it and the enemy, when the platoon has suppressed the enemy's antitank weapons, or when the platoon is vulnerable to artillery fire and must move fast. The line formation has the following characteristics, advantages, and limitations:

- Control—Difficult.
- Fires:
 - Front and rear—Excellent (maximum firepower).
 - Flank—Poor.
- Security—Less than other formations due to lack of depth.

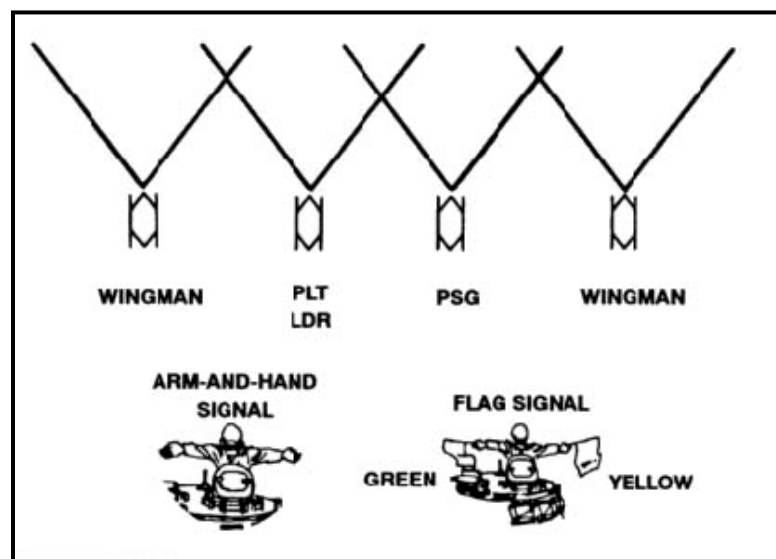

Figure 3-3. Line formation.

(4) **Echelon Formation.** When the company team wants to maintain security or observation of one flank, and when the platoon does not expect enemy contact, the platoon uses the echelon formation (Figure 3-4). The echelon formation covers the exposed flank of a larger force well, and has the following characteristics, advantages, and limitations:

- Control—Difficult.
- Fires:
 - Front—Excellent.
 - Flanks—Excellent for echelon sides.
- Security—Good, for echelon sides of higher formation.

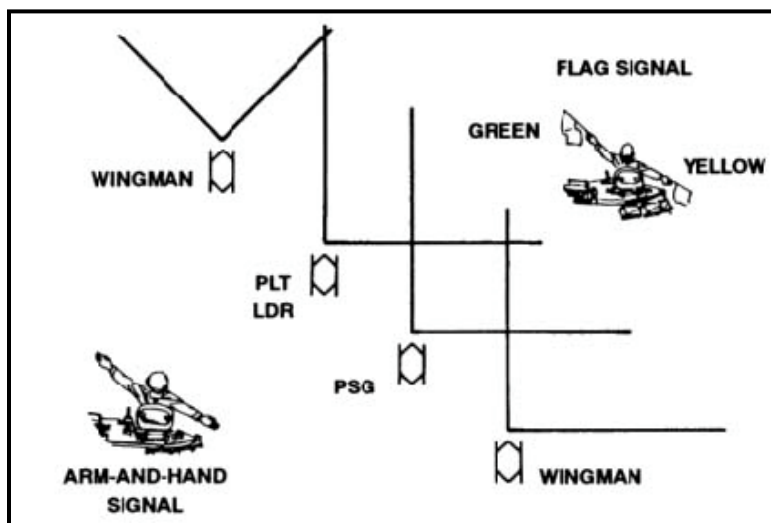

Figure 3-4. Echelon right formation.

(5) **Coil and Herringbone Formations.** The coil and herringbone are platoon-level formations employed when elements of the company team are stationary and must maintain 360-degree security.

(a) **Coil.** The coil (Figure 3-5) is used to provide all-round security and observation when the platoon is stationary. It is also useful for tactical refueling, resupply, and issuing platoon orders. Security is posted to include air guards and dismounted fire teams. The vehicle turrets are manned.

(b) **Herringbone.** The platoon uses the herringbone to disperse when traveling in column formation (Figure 3-6). They can use it during air attacks or when they must stop during movement. It lets them move to covered and concealed positions off a road or from an open area and set up all-round security without detailed instructions. They reposition the vehicles as needed to take advantage of the best cover, concealment, and fields of fire. Fire team members dismount and establish security.

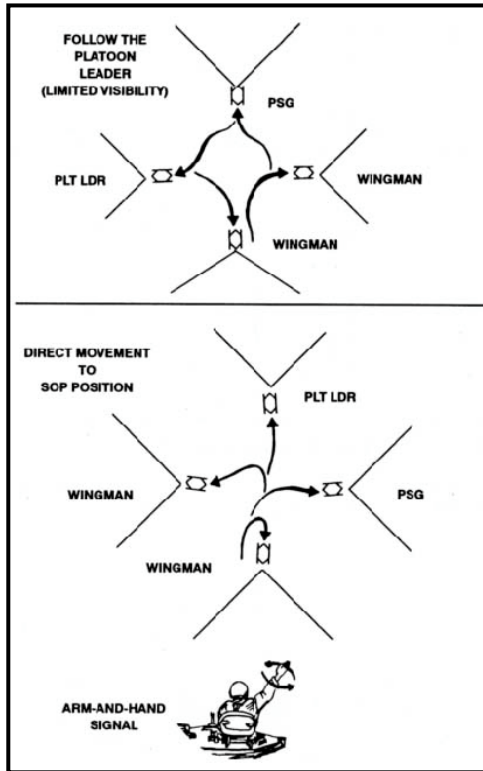

Figure 3-5. Coil formation.

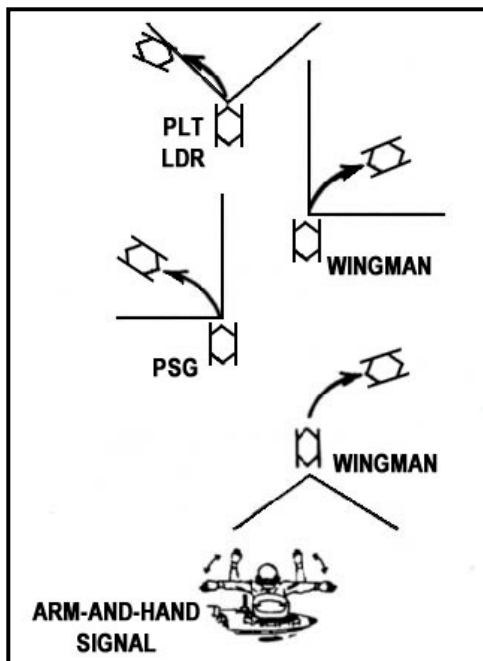

Figure 3-6. Herringbone formation.

3-2. DISMOUNTED MOVEMENT FORMATIONS

Infantry squads normally move mounted until the situation requires them to dismount. The squad moves alone or as part of the platoon’s dismounted element. Either the platoon’s mounted element or other fire teams from the dismounted element overwatch the rifle squad’s movement. Rifle squads use a variety of formations:

a. **Fire Team Formations.** The term “fire team formation” refers to the soldiers’ relative positions within the fire team (Table 3-1). Each type of formation has advantages and disadvantages. The leader weighs these against his METT-TC analysis:

MOVEMENT FORMATION	WHEN MOST OFTEN USED	CHARACTERISTICS			
		CONTROL	FLEXIBILITY	FIRE CAPABILITIES AND RESTRICTIONS	SECURITY
FIRE TEAM WEDGE	Basic fire team formation	Easy	Good	Allows immediate fires in all directions	All-round
FIRE TEAM FILE	Close terrain, dense vegetation, limited visibility conditions	Easiest	Less flexible than wedge	Allows immediate fires to the flanks, masks most fires to the rear	Least

Table 3-1. Comparison of fire team formations.

(1) **Wedge Formation.** This is the fire team’s basic formation. The wedge expands and contracts to take advantage of the terrain. When rough terrain, limited visibility, or other factors make control difficult, the fire team modifies the wedge. Team members reduce the normal intervals so that all team members can still see their team leader, and so each team leader can still see his squad leader. The sides of the wedge can contract to the point that the wedge resembles a single file. In less rugged terrain, where the leader can control movement more easily, soldiers expand or resume their original positions. Figure 3-7 shows the fire team wedge.

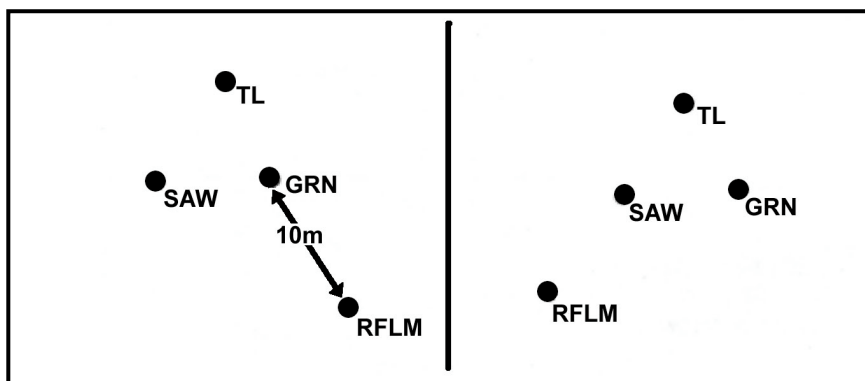

Figure 3-7. Fire team wedge.

(2) **File Formation.** When the terrain precludes use of the wedge, fire teams use the file formation (Figure 3-8).

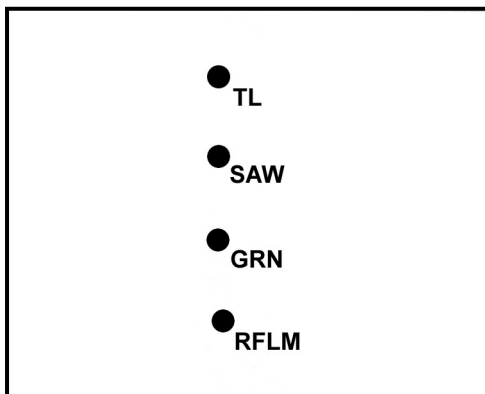

Figure 3-8. Fire team file.

b. **Squad Formations.** The term “squad formation” refers to the relative locations of the fire teams. Squad formations include the squad column, the squad line, and the squad file. Table 3-2 compares squad formations.

MOVEMENT FORMATION	WHEN MOST OFTEN USED	CHARACTERISTICS			
		CONTROL	FLEXIBILITY	FIRE CAPABILITIES AND RESTRICTIONS	SECURITY
SQUAD COLUMN	The main squad formation	Good	Aids maneuver, good dispersion laterally and in depth	Allows large volume of fire to the flanks, but only limited volume to the front	All-round
SQUAD LINE	For maximum firepower to the front	Not as good as squad column	Limited maneuver capability (both fire teams com-matted)	Allows maximum immediate fire to the front	Good to the front, little to the flank and rear
SQUAD FILE	Close terrain, dense vegetation, limited visibility conditions	Easiest	Most difficult formation to maneuver from	Allows immediate fire to the flanks, masks most fire to the front and rear	Least

Table 3-2. Comparison of squad formations.

(1) **Squad Column.** The squad column is the squad’s main formation. It simplifies maneuver, and it provides good dispersion laterally and in depth without sacrificing control. The lead fire team serves as the base fire team. Squads move either in a column or modified wedge. Rough terrain, limited visibility, or other factors might cause the squad to modify the wedge into a file for control purposes. As the terrain becomes less rugged and control becomes easier, the soldiers assume their original positions (Figure 3-9, page 3-8).

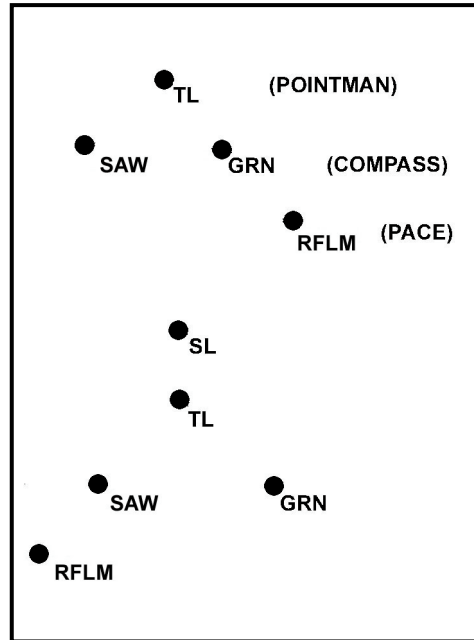

Figure 3-9. Squad column with fire teams in wedge.

(2) **Squad Line.** The squad line (Figure 3-10) provides maximum firepower to the front. When a squad acts as the base squad, the fire team on the right serves as the base fire team.

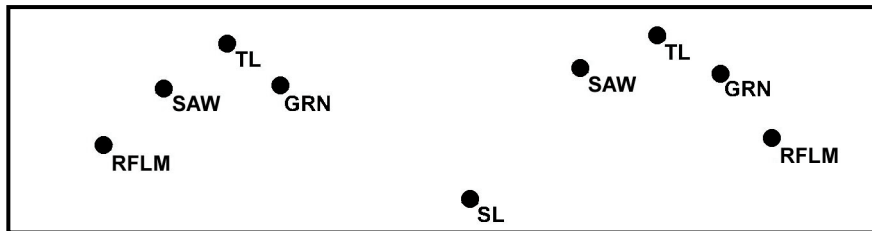

Figure 3-10. Squad line.

(3) **Squad File.** When not traveling in a column or line, squads travel in file (Figure 3-11). The squad file has the same characteristics as the fire team file. The squad leader moves forward to the first or second position if he wants to increase control over the formation, exert greater morale presence by leading from the front, and remain available to make key decisions at once. For more control over the rear of the formation, he moves a team leader to the last position. Platoon leaders and BCs have numerous ways to control the platoon's formations. To enhance awareness, they may have the rifle squads give position updates at regular intervals. When the platoon moves at normal dispersion intervals, the leader uses voice communications and visual contact to control movement.

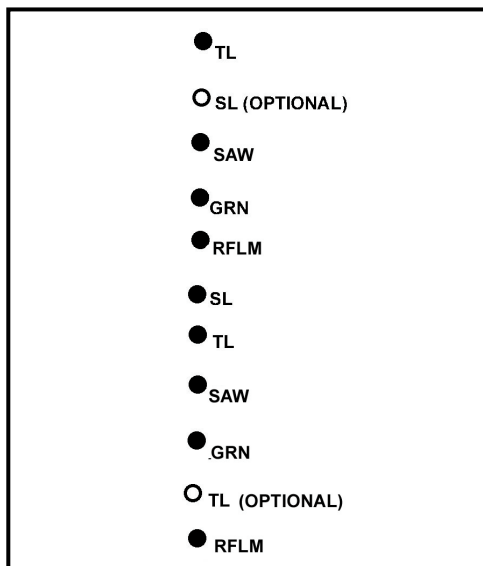

Figure 3-11. Squad file.

c. **Platoon Formation.** The platoon leader also tracks his platoon's formation and movement in conjunction with the company's formation.

3-3. MOVEMENT TECHNIQUES

The term "movement techniques" does not refer to the movement of fixed formations—it refers to the fluctuating distances *between* soldiers, teams, and squads. These distances vary based on the factors of METT-TC. As the probability of enemy contact increases, the platoon leader adjusts the movement technique to provide greater security. For example, if an enemy update received from higher headquarters states that the enemy has moved much closer to the platoon than the platoon leader anticipated, he immediately switches the platoon from traveling overwatch to bounding overwatch.

a. **Traveling (Mounted).** The platoon travels mounted when contact with the enemy is not likely and speed is desired (Figure 3-12, page 3-10). The leader analyzes the latest information on the enemy and determines if contact with the enemy is unlikely. Because units generally move faster when traveling mounted, leaders must remember the increased potential for a break in contact. This means more to the nondigitized platoon than it does to the digitized platoon. Should a break in contact occur:

(1) The leader or detached element uses GPS aids to reestablish contact with the main body.

(2) The platoon's main body can use an infrared or thermal source to regain visual contact with the element and link it back to the main body.

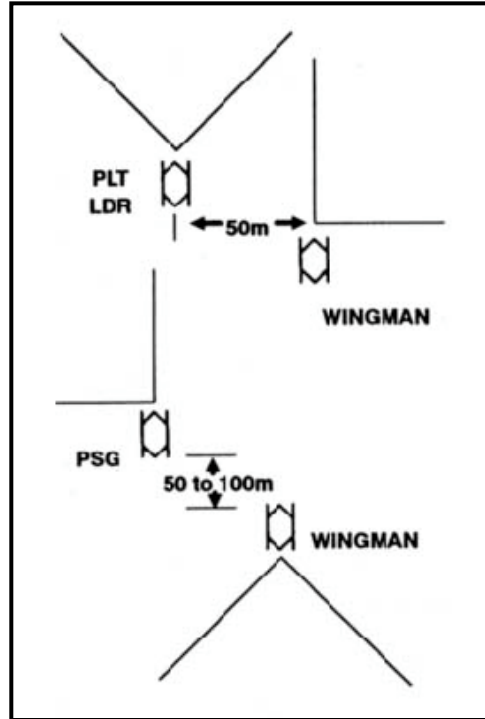

Figure 3-12. Traveling, platoon mounted.

b. **Traveling Overwatch (Mounted).** The platoon leader uses traveling overwatch when he thinks contact could occur (Figure 3-13). He designates one of his subordinate elements to provide security forward of the main body. In some cases, the improved awareness might prompt the security element to increase these distances. Leaders track the movement of forward security elements.. They get position updates to ensure the forward security element remains on azimuth and within range of supporting direct fires.

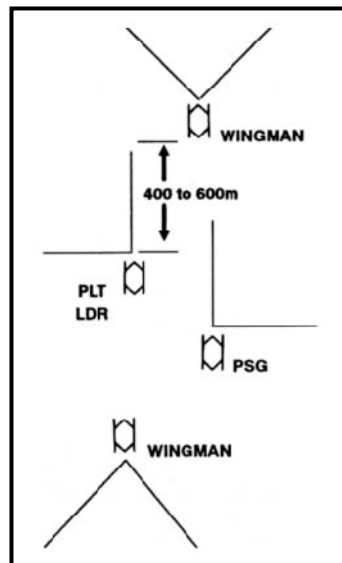

Figure 3-13. Traveling overwatch.

c. **Bounding Overwatch (Mounted).** When the platoon leader expects enemy contact, he uses bounding overwatch (Figure 3-14). He initiates it based on planning information received earlier about the enemy situation and on SITREPs received during movement. He bounds elements using successive or alternate bounds (Figures 3-15).

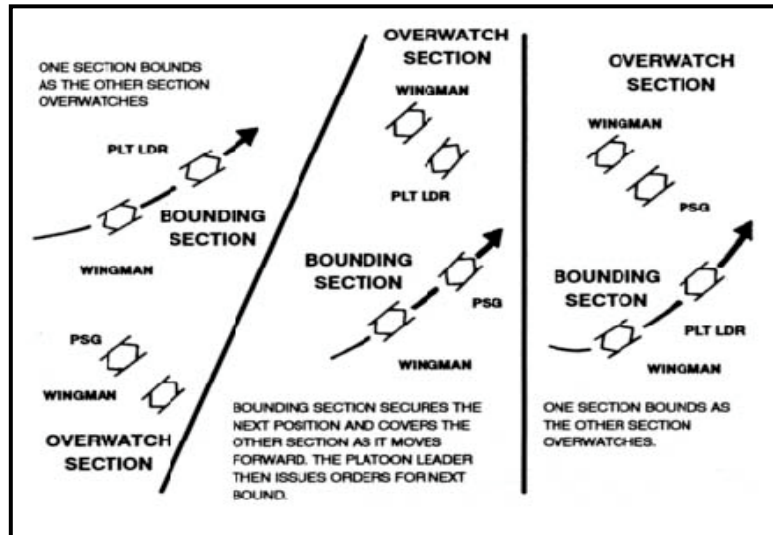

Figure 3-14. Bounding overwatch.

(1) Before bounding, the leader shows the bounding element the location of the next overwatch position. Ideally, the overwatch element keeps the bounding element in sight.

(2) Once the bounding element reaches its overwatch position, it signals “READY” by voice or visual means to the element that overwatched its bound. The platoon leader makes sure the bounding element stays within two-thirds of the weapons range of the overwatch element.

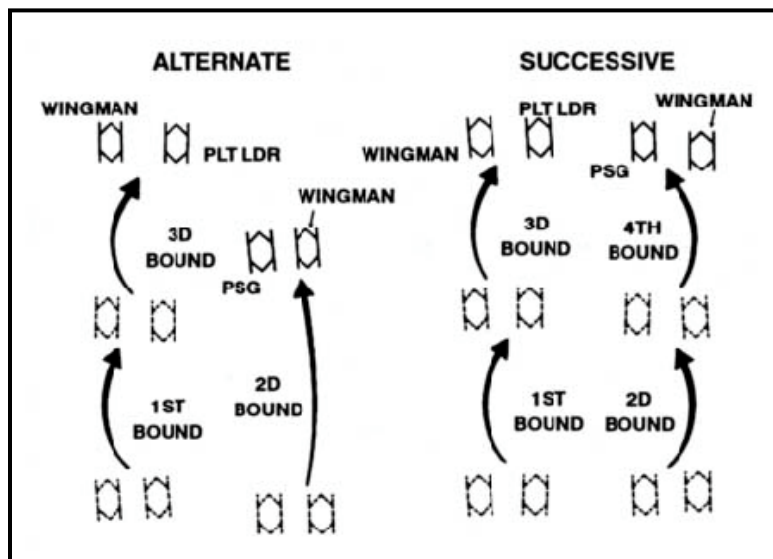

Figure 3-15. Methods of bounding overwatch.

d. **Traveling (Dismounted).** Some platoon missions may require that rifle squads to operate independently of the BFVs. The trailing rifle squad in a formation may use the traveling technique (Figure 3-16). The element's formation adjusts to fit the situation.

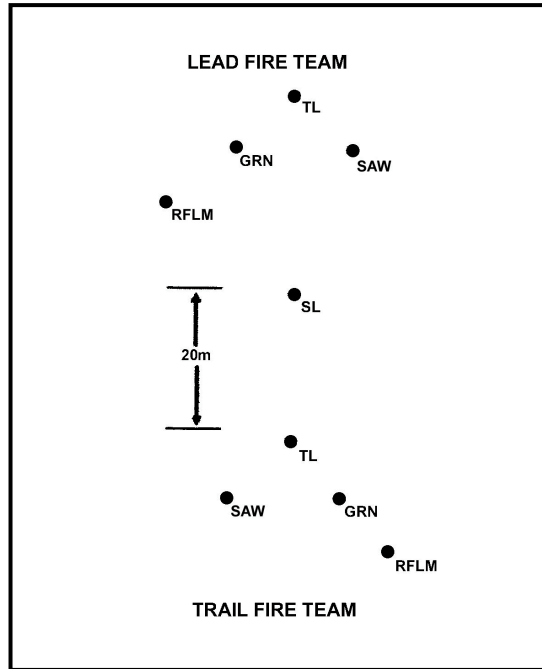

Figure 3-16. Traveling, squad dismounted.

e. **Traveling Overwatch (Dismounted).** Rifle squads normally move in column or wedge formation (Figure 3-17). Ideally, the lead team moves at least 50 meters in front of the rest of the element.

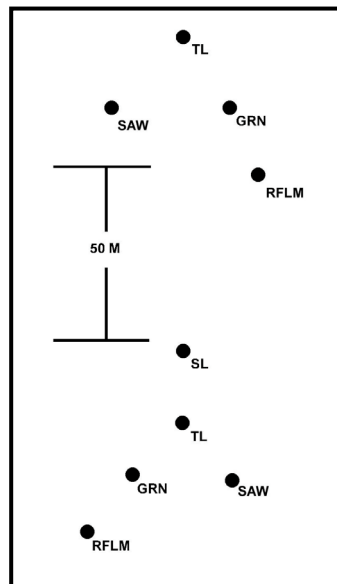

Figure 3-17. Traveling overwatch, squads dismounted.

f. **Bounding Overwatch (Dismounted).** When the platoon leader expects contact and the terrain prohibits mounted movement, or when the rifle squads move separated from the vehicles, the platoon (-) bounds with the rifle squads deployed.

3-4. ACTIONS AT DANGER AREAS

When analyzing the terrain during the troop-leading procedures (during his METT-TC analysis), the platoon leader may identify “danger areas.” When planning the route, the platoon leader marks the danger areas on his digital concept sketch and overlay. The term “danger area” refers to any area on the route where the terrain would expose the platoon to enemy observation, fire, or both. Examples include large open areas, roads and trails, and bridges or crossing sites over water obstacles. If he can, the platoon leader plans avoid danger areas, but sometimes he cannot. Navigational aids help, but when using them, the platoon and squads should always know their own location. Naturally, when the unit must cross a danger area, it does so as quickly and carefully as possible. During planning, the leader designates near side and far side rally points. If the platoon encounters an unexpected danger area, it uses the en route rally points closest to the danger area as far side and near side rally points.

a. **Crossing Large Open Areas (Mounted).** If time and terrain permit, the platoon should dismount infantry to reconnoiter the movement route and secure the far side of the open area. However, the distances between covered and concealed positions may make the use of dismounted infantry impractical. If time constraints prevent the platoon from bypassing a large open area, then the platoon uses a combination of traveling overwatch and bounding overwatch to cross the open area. When the platoon has to move across large open areas with limited cover and concealment, the platoon leader should consider the factors of METT-TC before firing indirect or direct fire while the platoon moves. Also, indirect-fire weapons can provide concealment by firing smoke alone or mixed with suppressive fires.

(1) **Traveling Overwatch.** The lead element moves continuously along the covered and concealed routes that give it the best available protection from possible threat observation and direct fire (Figure 3-18, page 3-14). The trail element moves at variable speeds, providing continuous overwatch, keeping contact with the lead element, and stopping periodically to get a better look. The trail element stays close enough to provide immediate suppressive fire and to maneuver for support. However, it must stay far enough to the rear to retain freedom of maneuver, in case an enemy force engages the lead element.

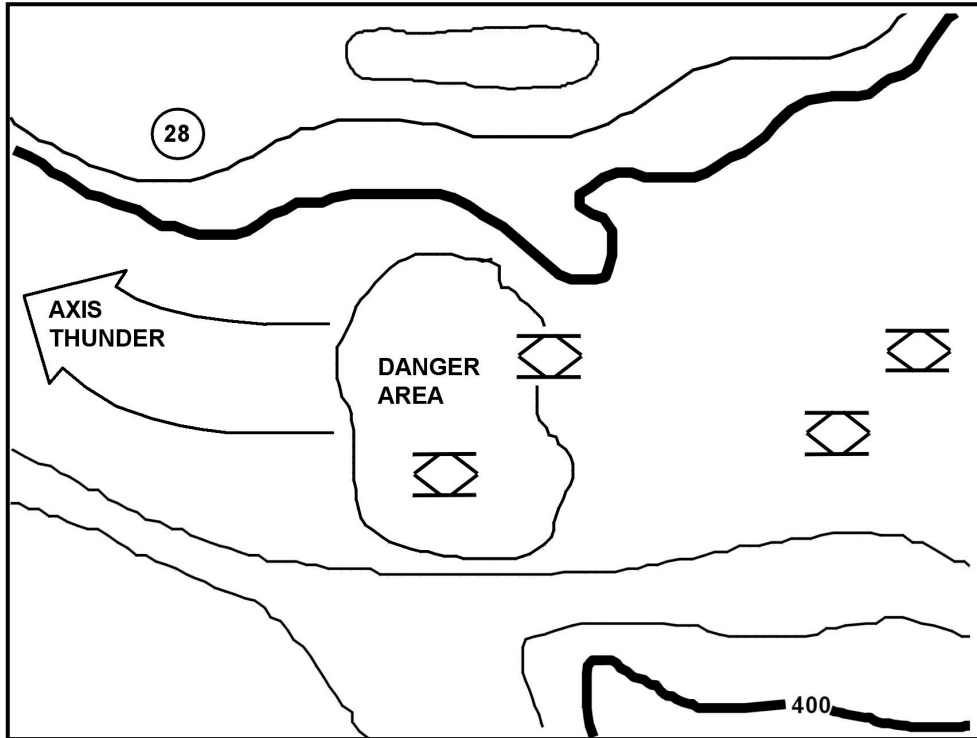

Figure 3-18. Crossing large open areas mounted (traveling overwatch).

(2) **Bounding Overwatch.** When expecting contact, the platoon should use the slowest, most secure movement technique (Figure 3-19). If any threat force engages the bounding element with direct fire, the platoon can suppress it at once with its own direct fire. With bounding overwatch, one element is always stopped to provide overwatching fire. First, the trail element occupies a covered and concealed position where it can overwatch the lead element. As soon as the lead element completes its bound (movement), it occupies a similar position and becomes the overwatch element. It overwatches while the new trail element (formerly the overwatch element) bounds forward to the next overwatch position. The platoon uses the folds in the earth and any other concealment to mask its movement. The platoon can execute a bounding overwatch using one of the methods discussed earlier in this chapter.

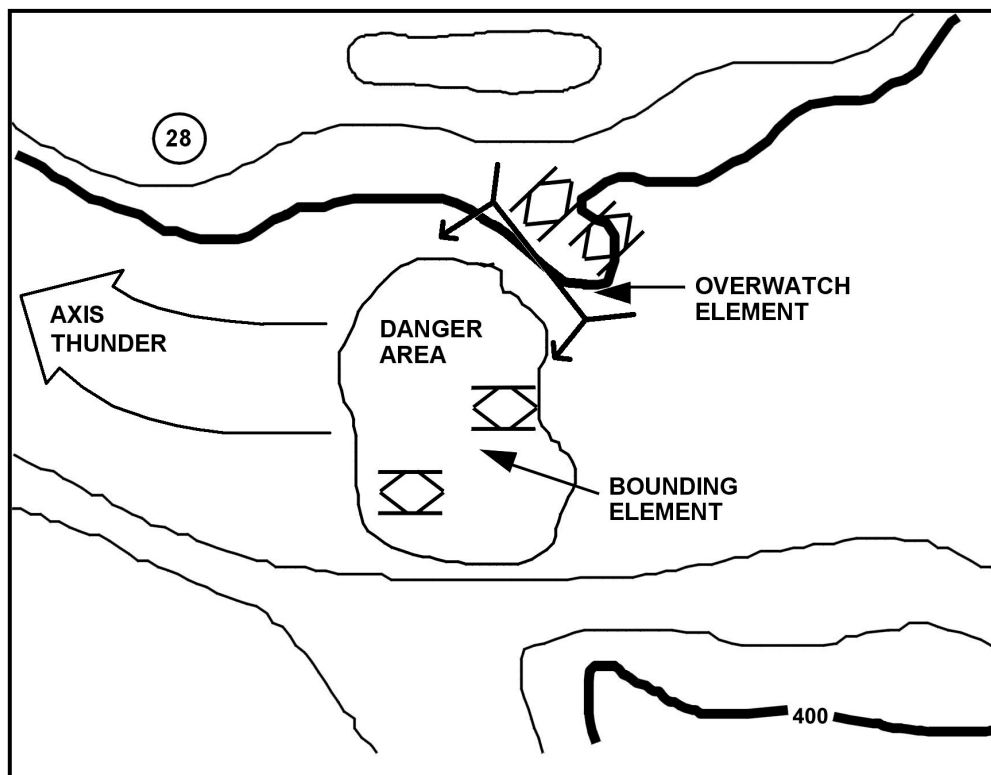

Figure 3-19. Crossing large open areas mounted (bounding overwatch).

b. **Crossing Large Open Areas (Dismounted).** When the platoon lacks the time to bypass a large open area, it uses a combination of traveling overwatch and bounding overwatch (Figure 3-20, page 3-16). It uses traveling overwatch when it needs to save time. Wherever the platoon expects possible contact, or after the squad or platoon moves within small-arms range of the far side (within about 250 meters of it), the platoon uses bounding overwatch. Once past the open area, the squad or platoon reforms and continues the mission.

(1) **Far-Side Rally Point.** The squad bounds by fire teams into the wood line and clear an area large enough for the entire squad. The squad begins bounding overwatch when within effective small-arms range (about 250 meters).

(2) **Near-Side Rally Point.** The platoon should use the traveling overwatch formation. The platoon should not clear the rally point like a separate linear danger area. Teams and individuals increase the interval between them.

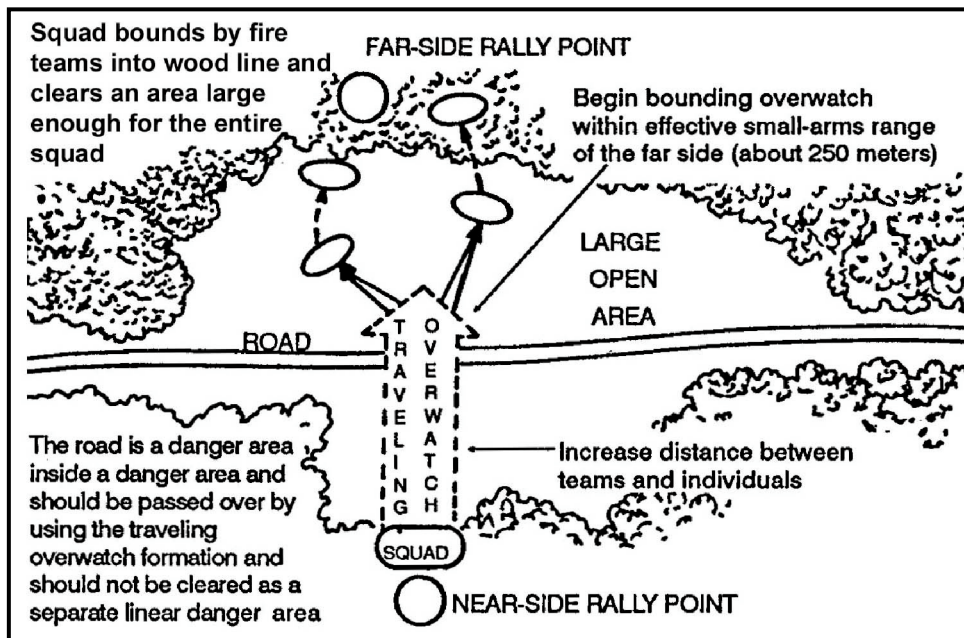

Figure 3-20. Crossing large open area.

c. **Crossing Small Open Areas (Dismounted).** When crossing an open area small enough to bypass in the time allowed for the mission, the platoon uses one of two techniques (Figure 3-21).

(1) **Detour Bypass Method.** The squad or platoon turns 90 degrees to the right or left around the open area and continues to move until it reaches the far side. Then, it continues the mission. The distance of the planned route does not include the pace count of the offset and return legs.

(2) **Contouring Around the Open Area.** Using the movement azimuth, the leader designates a rally point on the far side, decides which side of the open area to contour around (after considering the distance, terrain, and cover and concealment), and moves around the open area. He uses the wood line and vegetation for cover and concealment. When the squad or platoon arrives at the rally point on the far side, the leader aligns himself with the azimuth to the objective area, then continues the mission.

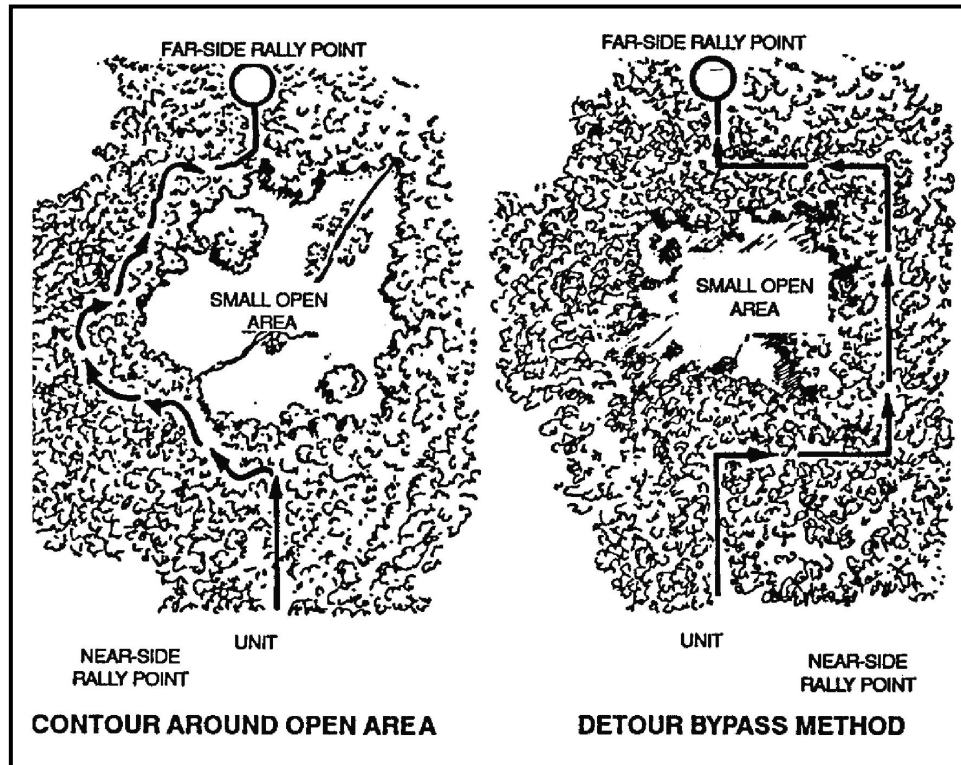

Figure 3-21. Crossing a small open area.

d. **Crossing Linear Danger Area (Dismounted).** The platoon crosses a linear danger area in the formation and location specified by the platoon leader (Figure 3-22, page 3-18). When the lead team signals “danger area” (relayed throughout the platoon, the platoon halts. The platoon leader quickly moves forward, confirms the danger area, and determines what technique the platoon will use to cross. The platoon sergeant (or designated NCO, if the platoon sergeant remains with the BFVs) also moves forward to the platoon leader.

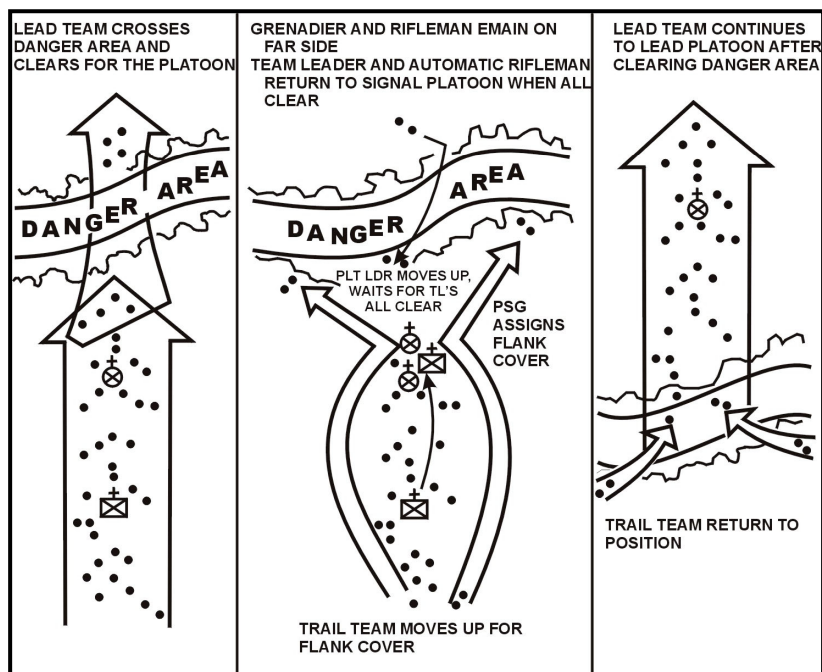

Figure 3-22. Crossing a linear danger area.

(1) The platoon leader informs all of the squad leaders of the situation and identifies the near-side and far-side rally points. He reconnoiters the danger area and selects the crossing point that provides the best available cover and concealment.

(2) The platoon sergeant directs positioning of the near-side security (usually conducted by the trail rifle squad). The near-side security element observes the flanks and overwatches the crossing. When the near-side security element is in position, the platoon leader directs the far-side security element (a fire team from the lead squad) to cross the danger area.

(3) The far-side security element clears the far side. The far-side security element leader establishes an OP forward of the cleared area. The cleared area must be large enough to allow full deployment of the remainder of the platoon. The team leader signals his squad leader that the far side is clear. The squad leader relays this message to the platoon leader.

(4) The platoon leader selects the method for the remainder of the platoon use to cross the linear danger area. Once the platoon crosses the linear danger area, the main body begins moving slowly on the designated azimuth. The near-side security, controlled by the platoon sergeant, crosses the linear danger area where the platoon crossed. The platoon sergeant ensures that everyone in the platoon has crossed and sends a report to the platoon leader.

(5) The platoon leader ensures accountability and resumes movement at normal speed.

e. **Making Enemy Contact at Danger Areas.** An increased awareness of the situation helps the platoon leader control the platoon when it makes contact with the enemy. If the platoon makes contact in or near the danger area, it moves to the designated rally points. Based on the direction of enemy contact, the leader still designates the far- or

near-side rally point. During limited visibility, he can also use his AN/PAQ-4B/C or AN/PEQ-2A to point out the rally points at a distance. If the platoon has a hard time linking up at the rally point, then the first element to arrive should mark the rally point with an infrared light source. This will help direct the rest of the platoon to the location. In an M2A3-equipped unit, he uses the rally point graphic control measure in the CTD, and then sends the data to his BCs and squad leaders. During movement to the rally point, position updates allow separated elements to identify each other's locations. These updates help them link up at the rally point by identifying friends and foes.

3-5. SECURITY DURING MOVEMENT

Security during movement includes whatever the platoon, vehicle crews, or squads do to secure the unit or the larger force. The leader obtains information about his location, the tactical situation, and the enemy. However, nothing replaces a head out of the turret, scanning the terrain, and looking for the enemy.

a. **Terrain.** When planning movements, the leader must consider how terrain affects security. The company commander should receive a copy of the modified combined obstacle overlay (MCOO) of the AO from battalion task force. The platoon leader may ask the company team commander for a copy of the MCOO for his AO. Once he receives this, he uses it and the commander's results of terrain analysis to analyze the terrain to find the best covered and concealed route for his mission. At the same time, he considers the other factors of METT-TC.

b. **Formations and Movement Techniques.** When choosing a movement formation or technique, the leader considers the most recent situational update and the level of C2 needed for the mission. He chooses the option that will provide the greatest security, and that will most likely result in mission accomplishment. During individual platoon movement, the platoon leader places a small element forward to allow the platoon to make contact with the smallest element possible. This gives the rest of the platoon freedom to maneuver.

c. **Light Discipline.** If soldiers need more illumination than an image intensifier can provide in infrared mode during dismounted movement, they should also use other infrared light sources. The combination should provide the light needed, but with the least risk of enemy detection. When using infrared light, leaders must consider the enemy's night vision and infrared capabilities. For instance, an enemy with night vision capability can send infrared light signals plus, when the platoon uses infrared, the enemy can concentrate direct and indirect fire on it.

3-6. MANEUVER

Maneuver provides the foundation for battlefield employment. The term "maneuver" means "...the use of movement in combination with fire (or fire potential) employed to achieve a position of advantage with respect to the enemy, and to facilitate accomplishment of the mission." At the platoon level, maneuver forms the heart of every tactical operation and task. The platoon leader maneuvers his mounted element and rifle squads to close with, gain positional advantage over, and ultimately destroy the enemy.

a. **Base-of-Fire Element.** Combining fire and movement requires a base of fire. Some platoon elements remain stationary to provide protection for bounding elements by suppressing or destroying enemy elements.

(1) When possible, the base-of-fire element occupies positions that afford good cover and concealment, a clear view, and clear fields of fire. Once in position, the base-of-fire element suppresses known, likely, or suspected enemy elements and at the same time aggressively scans its assigned sectors. It also identifies previously unknown elements, and then suppresses them with direct and indirect fires. The base-of-fire element allows the bounding unit to keep maneuvering so it can retain the initiative, even when the enemy can see and fire on it.

(2) Because maneuver is decentralized in nature, the platoon leader determines from his terrain analysis where and when he wants to establish a base of fire. During actions on contact, he adjusts maneuver plans as needed. Making maneuver decisions normally falls to the leader on a specific part of the battlefield—the one who knows what enemy elements can engage the maneuvering element and what friendly forces can provide the base of fire. Within a platoon, a section would provide a base of fire. Within a section, an individual vehicle or squad would do so.

b. **Bounding Element.** Maneuver is inherently dangerous. Enemy weapons, unknown terrain, and other operational factors all increase the danger. When maneuvering, the platoon leader considers the following.

(1) The bounding element must take full advantage of whatever cover and concealment the terrain offers. By enforcing and applying the principles of terrain driving, leaders and drivers, respectively, can enhance security. For example, they should always use intervening terrain and avoid “skylining.”

(2) All crews involved in the maneuver must always maintain all-round security at all times. Crewmen in the bounding element must continuously scan their assigned sectors of observation.

(3) Factors of METT-TC dictate the length of the bounds. However, the bounding element should never move beyond the range at which the base-of-fire element can effectively suppress known, likely, or suspected enemy positions ($2/3$ the effective range of the weapon system). Taking this precaution lessens the bounding element’s exposure to enemy fires.

(4) In severely restricted terrain, the bounding element makes shorter bounds than it would in more open areas.

(5) To clear intervening gaps or dead spaces, the bounding element may have to dismount infantry squads or teams. Although doing so usually forces the element to make a tactical pause, it will slow the operation less than losing a vehicle and crew to a hidden threat element.

(6) The bounding element must focus on its ultimate goal—gaining a positional advantage. Once achieved, the element uses this advantage to destroy the enemy with direct fires and dismounted infantry assault.

c. **Relationship of Tactical Movement and Actions on Contact.** The purpose of tactical movement is to move units on the battlefield to prepare them for contact with the enemy. The process they use to evolve from tactical movement to maneuver, if unplanned, is “actions on contact.” (Refer to Chapter 4, Section IV.)

CHAPTER 4

OFFENSIVE OPERATIONS

The purpose of offensive operations is to defeat, destroy, or neutralize an enemy force. Offensive operations are also undertaken to secure key terrain, to gain information, to deprive the enemy of resources, to deceive and divert him, to hold him in position, to disrupt his attack, and to set the conditions for successful future operations. The platoon's ability to mass combat power at the decisive time and place while maintaining the momentum of the attack at a tempo the enemy cannot match, is essential for successful offensive operations.

Section I. FUNDAMENTALS OF OFFENSIVE OPERATIONS

The outcome of decisive combat derives from offensive operations. Only through offensive operations can a platoon close with the enemy by means of fire and maneuver to destroy or capture him, or to repel his assault by fire, close combat, and counterattack. While tactical considerations may call for the platoon to execute defensive operations for a period of time, defeat of the enemy requires a shift to offensive operations. To ensure the success of the attack, the BFV infantry platoon leader must understand the following fundamentals of offensive operations and apply the troop-leading procedures during the operations process (For a discussion on the operations process refer to Chapter 2). A sound doctrinal foundation during offensive planning assists the platoon leader in capitalizing the tactical flexibility of a BFV infantry platoon.

4-1. CHARACTERISTICS OF OFFENSIVE OPERATIONS

Surprise, concentration, tempo, and audacity characterize all offensive. To maximize the value of these characteristics, BFV infantry platoon leaders must apply the following considerations.

a. **Surprise.** Platoons achieve surprise by attacking the enemy at a time or place he does not expect, or in a manner for which he is unprepared. Unpredictability and boldness, within the scope of the commander's intent, help the platoon to gain surprise. Total surprise is rarely essential; simply delaying or disrupting the enemy's reaction is usually effective. Surprise delays the enemy's reactions, stresses his command and control, and induces psychological shock in his soldiers and leaders. The platoon's ability to attack during limited visibility, to operate as a small unit, and to infiltrate are often key to achieving surprise. The platoon must exploit the effect of surprise on the enemy before he can recover.

b. **Concentration.** Platoons achieve concentration by massing overwhelming effects of their weapon systems and rifle squads, without necessarily massing platoon vehicles and squads at a single location, to achieve a single purpose. Because the attacker moves across terrain the enemy has prepared, he may expose himself to the enemy's fires. By concentrating overwhelming combat power, the attacker can reduce the effectiveness of enemy fires and the amount of time he is exposed to those fires. Modern navigation tools (such as GPS) allow the platoon leader to disperse his vehicles while retaining the ability to quickly mass the effects of the platoon's weapon systems whenever necessary.

c. **Tempo.** Tempo is the rate of speed of military action. Controlling or altering that rate is essential for maintaining the initiative. While a fast tempo is preferred, the platoon leader must remember that synchronization sets the stage for successful accomplishment of the platoon's mission. To support the commander's intent, the platoon leader must ensure that his platoon's movement is synchronized with the company's movement and with that of the other platoons. If the platoon is forced to slow down because of terrain or enemy resistance, the commander can alter the tempo of company movement to maintain synchronization. The tempo may change many times during an offensive operation. The platoon leader must remember that it is more important to move using covered and concealed routes to positions from which the platoon can mass the effects of direct fires on the enemy than it is to maintain precise formations and predetermined speeds.

d. **Audacity.** Audacity is a simple plan of action, boldly executed. It is the willingness to risk bold action to achieve positive results. Knowledge of the commander's intent two levels up allows the platoon leader to take advantage of battlefield opportunities whenever they present themselves, enhancing the effectiveness of the platoon's support for the entire offensive operation. Audacity, marked by disciplined initiative, inspires soldiers to overcome adversity and danger.

4-2. TYPES OF OFFENSIVE OPERATIONS

The four types of offensive operations, described in FM 3-90, are *movement to contact*, *attack*, *exploitation*, and *pursuit*. Company teams can execute movements to contact and attacks. Platoons generally conduct these forms of the offense as part of a company team. Company teams and platoons participate in a higher unit's exploitation or pursuit. The nature of these operations depends largely on the amount of time and enemy information available during the planning and preparing for the operation phases. Company teams and platoons participate in an exploitation or pursuit as part of a larger force.

a. **Movement to Contact.** The movement to contact (MTC) is a type of offensive operation designed to develop the situation, and establish or regain contact. The platoon will likely conduct a MTC as part of a company team when the enemy situation is vague or not specific enough to conduct an attack. (For a detailed discussion of MTC refer to Section V.)

b. **Attack.** An attack is an offensive operation that destroys enemy forces, or seizes or secures terrain. Movement, supported by fires, characterizes the conduct of an attack. The platoon will likely participate in a synchronized company team attack. However a platoon may conduct a special purpose attack as part of, or separate from, a company team offensive or defensive operation. Special purpose attacks consist of ambush, spoiling attack, counterattack, raid, feint, and demonstration. (For a detailed discussion of attack and special purpose attacks refer to Sections VI and VII.)

c. **Exploitation.** Exploitations are conducted at the battalion task force level and higher. The objective of exploitation is to complete the destruction of the enemy following a successful attack. Company teams and platoons may conduct movements to contact or attacks as part of a higher unit's exploitation.

d. **Pursuit.** Pursuits are conducted at the company team level and higher. A pursuit typically follows a successful exploitation. The pursuit is designed to prevent a fleeing enemy from escape and to destroy him. Company teams and platoons may conduct attacks as part of a higher unit's exploitation.

4-3. FORMS OF MANUEVER

Given the typical sequence for offensive operations (refer to Section II), the platoon maneuvers against the enemy in an area of operation. Maneuver places the enemy at a disadvantage through the application of friendly fires and movement. The five forms of maneuver are:

- Envelopment.
- Turning movement.
- Infiltration.
- Penetration.
- Frontal attack.

a. **Envelopment.** Envelopment (Figure 4-1) is a form of maneuver in which an attacking force seeks to avoid the principle enemy defenses by seizing objectives to the enemy rear or flank in order to destroy him in his current positions. “Flank attacks” are a variant of envelopment in which access to the enemy’s flank and rear results in enemy movement. A successful envelopment requires discovery or creation of an assailable flank. The envelopment is the preferred form of maneuver because the attacking force tends to suffer fewer casualties while having the most opportunities to destroy the enemy. A platoon may conduct the envelopment by itself or as part of the company team’s attack. Envelopments focus on:

- Seizing terrain.
- Destroying specific enemy forces.
- Interdicting enemy withdrawal routes.

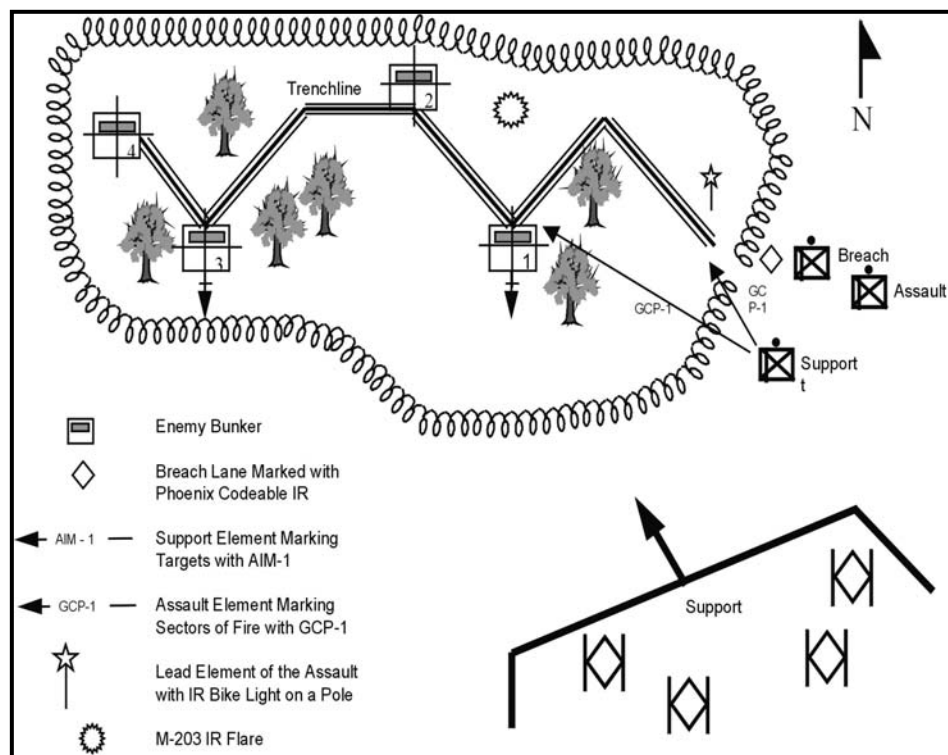

Figure 4-1. Envelopment.

b. **Turning Movement.** Turning movement (Figure 4-2) is a form of maneuver in which the attacking force seeks to avoid the enemy's principle defensive positions by seizing objectives to the enemy's rear and causing the enemy to move out of his current positions or to divert major forces to meet the threat. For a turning movement to be successful, the unit trying to turn the enemy must attack something that the enemy will fight to save. This may be a supply route, artillery emplacement or a headquarters. In addition to attacking a target that the enemy will fight to save, the attacking unit should be strong enough to pose a real threat to the enemy. A platoon will likely conduct a turning movement as part of a company team supporting a task force attack.

NOTE: The turning movement is different from envelopment because the force conducting the turning movement seeks to make the enemy displace from his current location whereas an enveloping force seeks to engage the enemy in his current location from an unexpected direction.

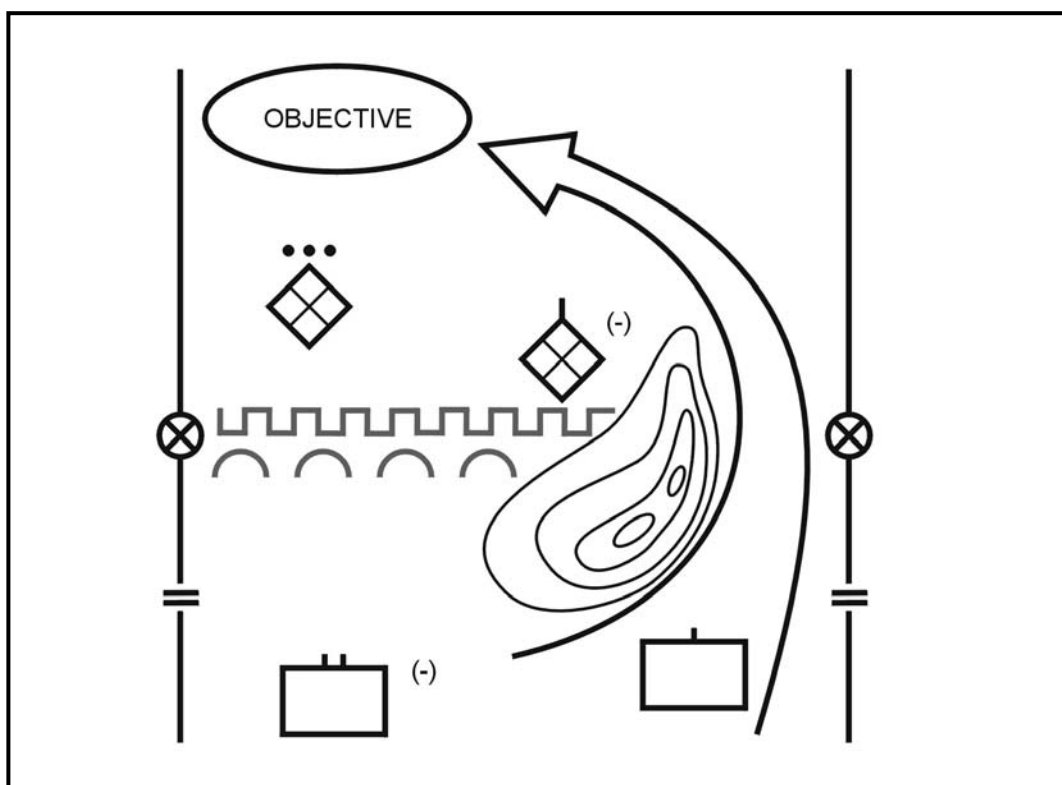

Figure 4-2. Turning movement.

c. **Infiltration.** Infiltration (Figure 4-3) is a form of maneuver in which an attacking force conducts undetected movement through or into an area occupied by enemy forces to occupy a position of advantage in the enemy rear while exposing only small elements to enemy defensive fires. Moving and assembling forces covertly through enemy positions takes a considerable amount of time. A successful infiltration reaches the enemy's rear without fighting through prepared positions. An infiltration is normally used

in conjunction with and in support of another form of maneuver. A platoon may conduct an infiltration (dismounted or mounted) as part of a larger unit's attack with the company team employing another form of maneuver. The platoon leader may also employ the form of maneuver by infiltration his squads to a location to support the attack of the mounted element. A platoon may conduct an infiltration in order to:

- Attack enemy-held positions from an unexpected direction.
- Occupy a support-by-fire position to support an attack.
- Secure key terrain.
- Conduct ambushes and raids.
- Conduct a covert breach of an obstacle.

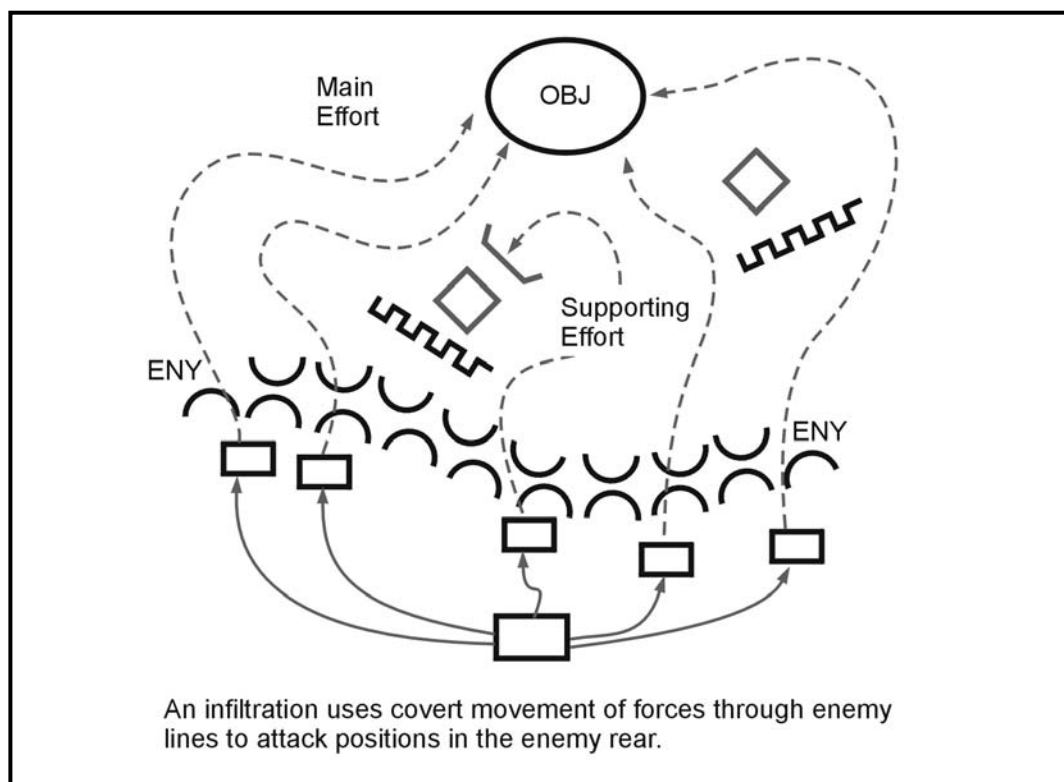

Figure 4-3. Infiltration.

d. **Penetration.** Penetration (Figure 4-4, page 4-6) is a form of maneuver in which an attacking force seeks to rupture enemy defenses on a narrow front to create both assailable flanks and access to the enemy's rear. Penetration is used when enemy flanks are not assailable, when enemy defenses are overextended, when weak spots in the enemy defense are identified, and when time does not permit some other form of maneuver. A penetration normally consists of three steps:

- Breach the enemy's main defense positions.
- Widen the gap created to secure flanks by enveloping one or both of the newly exposed flanks.
- Seize the objective.

As part of a larger force penetration, the BFV infantry platoon will normally isolate, suppress, fix, or destroy enemy forces, breach tactical or protective obstacles in the enemy's main defense, secure the shoulders of the penetration, or seize key terrain. A company team may also use the penetration to secure a foothold within a built-up area.

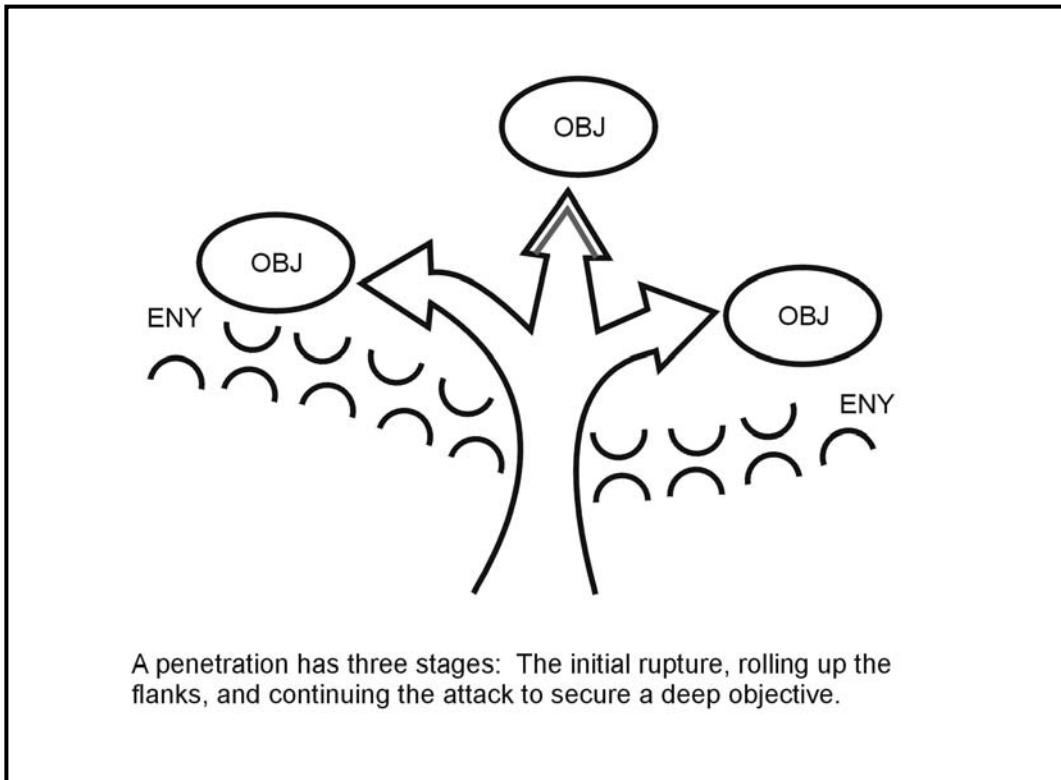

Figure 4-4. Penetration.

e. **Frontal Attack.** Frontal attack is a form of maneuver in which an attacking force seeks to destroy a weaker enemy force or fix a larger enemy force along a broad front. It is the least desirable form of maneuver because it exposes the attacker to the concentrated fire of the defender and limits the effectiveness of the attacker's own fires. However, the frontal attack is often the best form of maneuver for an attack in which speed and simplicity are key; it is useful in overwhelming weak defenses, security outposts, or disorganized enemy forces.

Section II. SEQUENCE OF OFFENSIVE OPERATION

As the platoon leader plans for an offensive mission, he generally considers the following sequence of events that apply to many, but not all, offensive operation.

- Assembly area.
- Reconnaissance.
- Movement to the line of departure.
- Maneuver.
- Deployment.

- Assault
- Consolidation and reorganization.

4-4. ASSEMBLY AREA

The platoon leader plans for the upcoming mission, and directs and supervises mission preparations in the assembly area (AA) to prepare the platoon for the upcoming battle. Preparation time in the assembly area allows the platoon to conduct precombat checks and inspections, rehearsals, and CSS activities. Typically, the BFV infantry platoon will conduct these preparations within a company team assembly area. Rarely, the platoon will occupy its own assembly area.

4-5. RECONNAISSANCE

All leaders should aggressively seek information about the terrain and the enemy. The enemy situation and available planning time may limit a unit's reconnaissance. In this circumstance, the platoon will likely conduct reconnaissance to answer the company team commander's PIR. An example may be to reconnoiter and time routes from the AA to the line of departure (LD). The platoon may also augment the efforts of the task force scouts to answer the task force commander's PIR.

NOTE: In digitally equipped units, this information may be available via FBCB2; however, leaders must never forget the benefit of having patrols and leaders on the ground to the front of the maneuver force.

4-6. MOVEMENT TO THE LINE OF DEPARTURE

The platoon will typically move from the AA to the LD as part of the company team movement plan. This movement plan may direct the platoon to move to an attack position to await orders to cross the LD. The attack position is the last position an attacking force occupies or passes through before crossing the LD. If so, the platoon leader must reconnoiter, time and rehearse the route to the attack position, and reconnoiter the actual position. Section and squad leaders must know where they are to locate within the assigned attack position. The company team commander may order all of the platoons to move within a company formation from the AA directly to the point of departure (PD) at the LD. The PD is the point where the unit crosses the LD and begins moving along a direction of attack or axis of advance. If one PD is used, it is important that not only the lead platoon reconnoiter, time, and rehearse the route to the PD, but also the trail platoons. This allows the company team commander to maintain synchronization. The company team commander may also designate a PD along the LD for each platoon in order to maintain synchronization and flexibility.

4-7. MANUEVER

The company team commander will plan the approach of all platoons to the objective to ensure synchronization, security, speed, and flexibility. He will select the routes, movement techniques and formations and the methods of movement (mounted or dismounted) of the platoons that best supports his intent for actions on the objective. The platoon leader must recognize this portion of the battle as a fight, not as a movement. He must be prepared to make contact with the enemy. (For a detailed discussion of actions

on contact refer to Section III.) He must plan accordingly to reinforce the commander's needs for synchronization, security, speed, and flexibility. During execution, he may display disciplined initiative and alter his platoon's formation, technique, or speed to maintain synchronization with the other platoons and flexibility for the company team commander.

4-8. DEPLOYMENT

As the platoon deploys and moves toward the assault position, it begins the final positioning of the BFVs (or squads), as directed by the company team commander, to minimize delay and confusion. An assault position is a covered and concealed position short of the objective from which final preparations are made to assault the objective. This tactical positioning allows the platoon to move in the best tactical posture through the assault position into the attack. Movement should be as rapid as the terrain, unit mobility, and the enemy situation permit. The probable line of deployment (PLD) is usually the next control measure following the assault position; however, the PLD may be located within the assault position. The PLD is a phase line that the company team commander designates as the location where he intends to completely deploy his unit into the assault formation before beginning the assault.

4-9. ASSAULT

During an offensive operation, the platoon's objective may be terrain-oriented or force-oriented. Terrain-oriented objectives may require the platoon to seize or retain a designated area and often require fighting through enemy forces. If the objective is force-oriented, an AO may be assigned for orientation, but the platoon's efforts are focused on the enemy's actual location. Actions on the objective begin when the company team (or platoon) begins placing direct and indirect fires on the objective. This may actually occur while the platoon is still moving toward the objective from the assault position or PLD.

4-10. CONSOLIDATION AND REORGANIZATION

The platoon consolidates and reorganizes as required by the situation and mission. Consolidation is the process of organizing and strengthening a newly captured position so that it can be defended. Reorganization is the actions taken to shift internal resources within a degraded unit to increase its level of combat effectiveness. The platoon executes follow-on missions as directed by the company team commander. A likely mission may be to continue the attack against enemy within the AO. Regardless of the situation, the platoon must posture itself and prepare for continued offensive operations.

Section III. BATTLEFIELD OPERATING SYSTEMS PLANNING CONSIDERATIONS

The BOS are a listing of critical tactical activities that provides a means of reviewing preparation and execution. Synchronization and coordination among the BOS are critical for success. Selected BOS are addressed in this section. (For a detailed discussion of C2 and intelligence, refer to Chapter 2.)

4-11. MANEUVER

The purpose of maneuver is to close with and destroy the enemy. Maneuver requires a base-of-fire element to suppress and or destroy enemy forces with accurate direct fires and bounding elements to gain positional advantage over the enemy. When effectively executed, maneuver leaves enemy elements vulnerable by forcing them to fight in two directions, robbing the enemy of the initiative and, ultimately, limits his tactical options.

4-12. FIRE SUPPORT

The platoon may be able to employ indirect fires from field artillery or battalion mortars to isolate a small part of the enemy defense or to suppress the enemy on the objective. The platoon leader must always keep in mind the potential danger to friendly elements created by indirect fires used in support of the assault. He must ensure that the indirect fire assets always know the position and direction of movement of the assault force.

4-13. MOBILITY, COUNTERMOBILITY, AND SURVIVABILITY

The platoon will likely focus on “mobility” during offensive operations. The platoon may be required to breach obstacles as part of an offensive operation. These may be protective obstacles that the platoon is expected to breach without additional assets or these may be tactical obstacles that the platoon will require engineer assets in order to breach. Refer to FM 3-34.2 for a detailed discussion of breaching.

4-14. AIR DEFENSE

A Bradley Stinger fighting vehicle (BSFV) or Linebacker may operate in the platoon’s AO. Although these assets do not necessarily work for or with the platoon, the platoon may have a specified (or implied) task to secure these air defense asset. The platoon leader must take this into consideration during this planning. The platoon leader should also address how to react to enemy air assets if no external assets are available or operating within his AO. Unit SOPs should dictate internal air security measures and active air defense measures.

4-15. COMBAT SERVICE SUPPORT

The primary purpose of CSS in the offense is to assist the platoon and company team in maintaining momentum during the attack. Key CSS planning considerations for the platoon leader during the offense include—

- Increased consumption of Class III supplies.
- High expenditure of ammunition for selected tactical tasks.
- Casualty evacuation procedures.
- Vehicle maintenance and recovery requirements.

Section IV. ACTIONS ON CONTACT

The four-step process for actions on contact is not a rigid, lockstep response to enemy contact; rather, it provides an orderly framework to help the platoon survive the initial contact. Leaders can follow up with sound decisions and act promptly to complete the operation. The platoon must react instinctively and instantly to the contact. The platoon leader’s initial consideration should be, “Did the enemy see us before we deployed to

cover?” The platoon leader decides what to do—he can have the platoon execute a planned battle drill or plan, or he can recommend to the company team commander that the platoon execute an alternate drill or action. At times, the platoon leader and his platoon must execute more than one of these steps at the same time. This is why the platoon must prepare thoroughly for contact situations. To ensure the platoon works well as a team and reacts correctly, yet instinctively, the platoon leader must rehearse battle drills and established unit SOPs. He must also conduct comprehensive training. The four-step process gives the platoon leader a logical, well-organized decision-making process for executing actions on contact. The four steps are:

- Deploy and report.
- Evaluate and develop the situation.
- Choose a course of action.
- Recommend and execute a course of action.

4-16. DEPLOY AND REPORT

The platoon leader deploys the platoon when he recognizes one of the general categories of initial contact or receives a report of contact with enemy or civilians.

- a. Contact situations include (but are not limited to) the following:
 - Visual contact (friendly elements may or may not be observed).
 - Physical contact with a superior, inferior or unknown enemy or with civilians.
 - Indirect fire contact.
 - Contact with obstacles of enemy or unknown origin.
 - Contact with enemy or unknown aircraft.
 - Situations involving NBC conditions.
 - Situations involving electronic warfare tactics such as jamming, interference, and imitative deception.

- b. When the platoon makes contact with the enemy, the platoon leader responds according to the circumstances of the situation. The BFV or squad that makes initial contact must react as appropriate. The platoon leader has several choices in deploying the platoon. In many cases, he will initiate one of the battle drills for the BFV platoon (Appendix E). He can also order his sections or squads to immediately seek the best available covered and concealed position. (If mounted, the platoon leader determines whether or not to dismount the rifle squads.) The position should afford unobstructed observation and fields of fire and allow the platoon to maintain flank security. Bradley crews will also seek cover and concealment in the absence of a deployment order from the platoon leader. This step concludes with the platoon leader or platoon sergeant sending a contact report to the company team commander followed as soon as possible by a SPOTREP (FM or digital).

4-17. EVALUATE AND DEVELOP THE SITUATION

While the platoon deploys by executing a battle drill or occupying a covered and concealed position, the platoon leader must begin to evaluate the situation and, as necessary, develop it. His primary focus is on determining or confirming the *size* (inferior or superior), *composition* (available weapon systems), *activity*, and *orientation* of the enemy force. He analyzes how obstacles and terrain in the AO will affect enemy and friendly capabilities and possible courses of action. The platoon leader uses reports from

his section and squad leaders, other platoon leaders, the executive officer, and the company commander to make his evaluation.

a. Because the BFV infantry platoon usually operates as part of a company team, task force scouts or other assets may be available to assist the commander and platoon leader in evaluating and developing the situation.

b. There are no established rules for determining the level of superiority of an enemy in relation to the platoon; the result is dependent on the situation. The general criteria are as follows:

(1) **Inferior Force.** An inferior force is defined as an enemy element that the platoon can destroy while remaining postured to conduct further operations.

(2) **Superior Force.** A superior force is one that can be destroyed only through a combined effort of company- or battalion-level combat and CS assets.

c. The platoon leader evaluates the enemy's capabilities, especially the number of lethal weapon systems that he knows the enemy has. He also considers the enemy's recent activities.

d. The enemy's lethality options vary. The enemy might use rapid-fire antitank weaponry, slow-firing wire-guided systems, or dismounted soldiers with automatic weapons. He can entrench forces in prepared fighting positions, or he can conduct a refueling operation with little security.

e. After making contact and evaluating the situation, the platoon leader may discover that he does not have enough information to determine the superiority or inferiority of the enemy force. To make this determination, he can further develop the situation using a combination of techniques including fire and maneuver, indirect fire, reconnaissance by fire, and surveillance. In such a situation, however, the platoon leader must exercise caution, ensuring that his actions support the commander's intent.

f. The platoon leader's most crucial considerations include mission accomplishment and the survivability of the platoon. Once the platoon leader determines what the platoon is up against, he or the platoon sergeant sends an updated SPOTREP to the company team commander. Once the platoon leader develops the situation and determines that he has enough information to make a decision, he selects a COA that accomplishes the mission, meets the requirements of the commander's intent, and is within the platoon's capabilities. He has several options in determining the COA:

- Direct the platoon to execute the original plan. The platoon leader selects the COA specified by the commander in the OPORD.
- Based on the situation, issue FRAGOs to refine the plan, ensuring it supports the company commander's intent.
- Report the situation and recommend to the company team commander an alternative course of action based on known information in response to an unforeseen enemy or battlefield situation.
- Direct the platoon to execute tactical movement (employing bounding overwatch and support by fire within the platoon) and reconnaissance by fire to further develop the situation and gain the information he needs to clarify a vague battlefield picture.

4-18. CHOOSE A COURSE OF ACTION

The platoon leader will have little time for analysis at this point, but he should already have developed a clear understanding of the available COAs. He considers the commander's intent and guidance to help him determine his choice of a COA.

a. In most cases, the commander will have identified the criteria for anticipated actions on contact in terms of the enemy's capabilities (that is, whether the enemy is a superior or inferior force). He will have specified criteria for destroying, fixing, and bypassing the enemy as well as the applicable disengagement criteria. He evaluates various reactions to possible enemy actions during planning, in the company rehearsal, during his informal war-gaming and during platoon rehearsals. He should also plan for the employment of indirect fires to support his COA.

b. Refinements to the original plan or development of a new COA may change the scheme of maneuver. In most situations, the intent of maneuver is to gain positions of advantage over the enemy, forcing him to fight in an unintended direction. One element moves to the position of advantage while another element overwatches and supports. Control of indirect fires is shifted to the observer who can best call for and adjust fire on the enemy. If necessary, the platoon leader issues a revised set of graphic control measures, as part of the FRAGO.

NOTE: M2A3-equipped platoons send the FRAGO and graphics through FBCB2 following the verbal FRAGO. The digital FRAGO and graphics may include waypoints to assist in navigation along desired routes to a position of advantage and TRPs to help the platoon orient weapons.

4-19. RECOMMEND AND EXECUTE A COURSE OF ACTION

Once he has chosen a COA, the platoon leader continues his evaluation of the situation by determining whether or not his COA aligns with the commander's intent and guidance from the order or rehearsal. If so, he orders the platoon to execute it, and he reports his intentions to the company team commander.

a. If, however, the situation dictates a change from the original plan, the platoon leader must recommend a new COA to the commander. He then directs the platoon to execute the COA selected by the commander, who may or may not follow the recommendation. The platoon leader communicates with other platoon leaders as necessary to obtain support IAW the commander's intent.

b. More information will become available as the platoon executes its COA. The platoon leader or platoon sergeant keeps the company team commander abreast of the situation with SPOTREPs and SITREPs. Accuracy of these reports is critical, because the task force commander and S2 eventually use them to confirm or deny the enemy situational template.

c. Key information the commander needs includes the size, activity, location, time observed, equipment (SALUTE) of any enemy elements that the platoon has observed, engaged, destroyed, or bypassed. The platoon leader also informs the commander of the platoon's current location or destination, and of any changes in the platoon's combat power or logistical status.

d. Based on details of the enemy situation, the platoon leader may have to alter his plan during execution. For example, as the platoon maneuvers to destroy what appears to

be a lone enemy tank, it might discover six more in prepared fighting positions (a superior force). In this case, the platoon leader informs the commander and recommends an alternate COA, such as the platoon occupying a support-by-fire while the remainder of the company team destroys the enemy tanks. The platoon continues to execute the selected or refined COA until it accomplishes the original mission, receives a FRAGO from the company team commander changing the mission or COA, or receives a new order to consolidate and reorganize on the objective.

EXAMPLE:

As the platoon maneuvers to destroy what appears to be a combat security outpost (CSOP) with one BMP-3 and an infantry squad, it discovers that the CSOP is actually manned by a reinforced MRP (three BMP-3s and one T-80U). The platoon leader must analyze and develop the new situation. He reports to the company team commander that the enemy is more than the platoon can handle and recommends an alternate course of action such as establishing a support-by-fire position to suppress the enemy as the remainder of the company team bounds forward to destroy the reinforced MRP.

Section V. MOVEMENT TO CONTACT

A movement to contact (MTC) is a type of offensive operation designed to develop the situation and establish or regain contact. A company team conducts an MTC when it must gain or maintain contact with the enemy (refer to Section III) or when it lacks sufficient time to gain information or make extensive plans to defeat the enemy. BFV infantry platoons and rifle squads participate in a movement to contact as part of a company team using movement formations and techniques explained in Chapter 3. The platoon, as part of a company team, will employ one of two techniques during a movement to contact: *approach march* or *search and attack*.

4-20. PLANNING CONSIDERATIONS

The company team commander will not have a complete visualization of the situation. The leader's role is to gain as much first hand information as possible. That combined with information on the enemy and the terrain provides the knowledge and understanding necessary to respond to the enemy. However, if the enemy situation remains vague, the platoon must be prepared to act in any situation. This is accomplished through proper planning, appropriate movement formations and techniques, fire control measures, platoon SOPs, engagement criteria, and studying the terrain before and during movement to anticipate likely enemy locations. While moving, all leaders study the terrain and anticipate enemy contact. The platoon leader may not know when or where he will make contact with the enemy and should avoid mounted movement on terrain restricting maneuver (such as draws, ravines, narrow trails, or steep slopes). If restrictive terrain is unavoidable, the platoon leader dismounts the rifle squads to enhance security in restrictive areas.

a. **Techniques.** BFV infantry platoons will participate in two techniques for conducting a movement to contact: approach march or search and attack. The approach march technique is used when the enemy is expected to deploy using relatively fixed offensive or defensive formations but the situation remains vague. The search and attack technique is used when the enemy is dispersed, when he is expected to avoid contact or quickly disengage and withdraw, or when the higher unit needs to deny him movement in an AO.

b. **Command and Control.** The company team commander will dictate a number of command and control techniques or graphic control measures for the unit to employ. The platoon leader may modify these techniques or control measures (within the scope of the company team commander's intent and guidance and the factors of METT-TC) in order to better control his sections and squads. Some examples of command and control techniques that may be modified are—

- Line of departure, phase lines, and checkpoints.
- Fire control and distribution.
- Indirect fire plan.

(1) **Line of Departure, Phase Lines, and Checkpoints.** The company team commander will normally assign lines of departure, phase lines, and checkpoints to control the forward movement of the platoon. The platoon does not stop at a phase line unless told to do so. If necessary, the platoon leader designates additional phase lines or checkpoints for use within the platoon to reduce the number and length of radio transmissions used to control movement.

(2) **Fire Control and Distribution.** The platoon uses boundaries, direct fire plans, pyrotechnics, signals, and FRAGOs for direct fire control and distribution. (For a detailed discussion of direct fire control and distribution refer to Appendix G.) The variety of weapons in the BFV infantry platoon makes it critical for all sections and squads to understand the observation plan and the designated sectors of fire during an MTC. This takes on importance because of the scarcity of information about the enemy.

(3) **Indirect Fire Plan.** The platoon leader must have a good indirect fire plan for his route to cover anticipated places of contact. These targets are a product of the platoon leader's analysis of the factors of METT-TC and must be incorporated into the company team indirect fire plan. The platoon leader, platoon sergeant, section leaders, or squad leaders may initiate the calls for fire.

c. **Developing the situation.** Once the platoon makes contact with the enemy, it maintains contact until the commander orders otherwise. The platoon leader develops the situation based on the effectiveness of enemy fire, friendly casualties, size of enemy force, and freedom to maneuver. He gathers and reports critical information about the enemy and recommends a course of action. The platoon can bypass the enemy with permission from the commander, conduct an attack, fix the enemy so another platoon can conduct the assault, conduct a defense, establish an ambush, or break contact. The following guidelines apply for the platoon to develop the situation after making contact.

(1) *Light resistance* is resistance from an enemy element, squad-sized or smaller, that is not inflicting friendly casualties; is not equipped with an armored vehicle, machineguns, or antiarmor assets; and is occupying hasty fighting positions with no tactical obstacles.

(a) Light resistance may be bypassed IAW the order, or when directed by the company team commander. Once the platoon reacts to contact and the leader makes the decision to bypass, the following actions occur:

- BFVs suppress the enemy and continue to move.
- Rifle Squads remains mounted.
- Platoon leader calls for and adjusts indirect fire and smoke to screen his movement past the enemy position.
- Platoon leader reports the size, activity, and location of the enemy to the company team commander, and the platoon continues the mission.

(b) When the platoon reacts to contact and decides to conduct an attack against light resistance, the actions are:

- Rifle squads dismount in covered and concealed locations.
- BFVs provide long-range supporting fires from a covered position.
- Platoon leader calls for and adjusts indirect fire to suppress the enemy.
- Rifle squads maneuver, supported by the fires of the BFVs, to destroy the enemy.
- Platoon conducts consolidation and reorganization, if required.
- Platoon leader reports the status and continues the mission.

(2) *Medium resistance* is resistance from an enemy squad- to platoon-sized element that is inflicting friendly casualties. The enemy defense is organized around the best defensible terrain with combined arms assets integrated. The platoon reacts to medium resistance using the following actions:

- BFVs move to a covered and concealed position to dismount the rifle squads.
- Platoon leader calls for and adjusts indirect fires to suppress the enemy and obscure movement with smoke.
- BFVs, rifle squads, or a combination of these immediately suppress the enemy from a covered position and continue to suppress while the assault element moves to the objective. The support element keeps fires in front of the assault element as they conduct the assault.
- The rifle squads conduct the assault using fire and movement. One squad (if not with the BFVs) supports-by-fire while the other two squads move. The platoon leader moves with the squads conducting the assault to control the movement and adjust or control all supporting fires.
- Once the assault element seizes the objective (or destroys the enemy) and begins consolidation, the platoon leader calls the BFVs forward.
- The platoon conducts consolidation and reorganization.

(3) *Heavy resistance* is resistance from an enemy platoon-sized element or larger that is inflicting heavy friendly casualties. The enemy is defending a strongpoint with combined arms assets. If a bypass or attack is not possible, the company team commander may instruct the platoon to fix the enemy. Fixing the enemy involves establishing a base-of-fire to prevent the enemy from repositioning any part of his force for use elsewhere. When enemy resistance is too heavy for the platoon to assault or an attack has failed, the actions of the platoon are:

- The platoon suppresses from support-by-fire positions to support the company team maneuver.

- The platoon leader calls for and adjusts indirect fires to suppress the enemy.
- The platoon prepares to lift or shift fires as other platoons conduct the assault.
- Depending on the company formation and order of movement, platoons must be prepared to support-by-fire for another platoon while it conducts the assault, or to conduct the assault while other platoons support-by-fire.
- If more than one platoon is involved, the commander issues instructions for direct fire control and distribution to the platoon leader. The platoon leader then controls the platoon fires.

d. **Defensive Considerations.** In some situations, a platoon conducting an MTC makes contact with a much larger and more powerful enemy force. If the platoon encounters a larger enemy force where the terrain gives the platoon an advantage, it should attempt to fix the enemy force. This allows the rest of the company team to maneuver against the force. If the platoon cannot fix the enemy, it may have to assume a defensive posture (refer to Chapter 5) or break contact. Because the defense may surrender the initiative to the enemy and means the enemy has fixed the platoon in place, the platoon should use it only if it is in danger of being overwhelmed. Exposed rifle squads are vulnerable to enemy indirect fires. If the platoon receives indirect fire during movement, it should use the protection of the BFVs and attempt to move out of the area or find a covered position for the rifle squads to dismount. Once the indirect fires cease, the platoon prepares for an enemy assault. In the defense, the platoon leader—

- Keeps the company team commander informed and continues to report on enemy strength, dispositions, and activities.
- Dismounts the rifle squads to cover dismounted avenues of approach in preparation for the enemy's attack.
- Places BFVs in hull-down positions (if available) or position that provide the best cover and concealment.
- Orients Javelins to augment the BFVs along mounted avenues of approach.
- Establishes direct fire control and distribution measures.
- Calls for and adjusts indirect fires.

4-21. APPROACH MARCH TECHNIQUE

The approach march is one of the methods of troop movement (*administrative movement, tactical road march, and approach march*). The approach march is the advance of a combat unit when direct contact with the enemy is intended. The concept behind the approach march as a technique for MTC is to make contact with the smallest element, allowing the commander the flexibility of maneuvering or bypassing the enemy force. During an approach march, the company team commander will organize his unit into two elements (advance guard and main body). As part of a company team using the approach march technique, platoons may act as the advance guard, the flank or rear guard, or they may also receive on-order missions as part of the main body.

a. **Advance Guard.** The advance guard operates forward of the main body to ensure its uninterrupted advance. It protects the main body from surprise attack and fixes the enemy to protect the deployment of the main body. As the advance guard, the platoon finds the enemy and locates gaps, flanks, and weaknesses in his defense. The advance guard attempts to make contact on ground of its own choosing, to gain the advantage of surprise, and to develop the situation (either fight through or support the assault of all or

part of the main body). The advance guard operates within the range of indirect fire support weapons. The platoon uses appropriate formations and movement techniques based on the factors of METT-TC.

b. **Flank or Rear Guard.** The platoon will have the responsibilities of flank or rear guard when moving within the company team main body; however, the platoon may act as the flank or rear guard for a battalion task force conducting a movement to contact using approach march technique. In either situation, the platoon:

- Moves using the appropriate formation and movement technique. (It must maintain the same momentum as the main body.)
- Provides early warning.
- Destroys enemy reconnaissance units.
- Prevents direct fires or observation of the main body.

c. **Main Body.** When moving as part of the main body, platoons may be tasked to assault, bypass, or fix an enemy force or to seize, secure, or clear an assigned area. The platoon may also be detailed to provide sections as flank or rear guards, stay-behind ambushes, or additional security to the front. Platoons and sections use appropriate formations and movement, assault, and ambush techniques.

4-22. SEARCH AND ATTACK TECHNIQUE

The search and attack is a technique for conducted when the enemy is operating as small, dispersed elements, or when the task is to deny the enemy the ability to move within a given AO. The platoon will participate as part of company or battalion search and attack. A unit conducts a search and attack for one or more of the following reasons:

- Render the enemy in the AO combat-ineffective.
- Prevent the enemy from operating unhindered in a given AO.
- Prevent the enemy from massing to disrupt or destroy friendly military or civilian operations, equipment, or facilities.
- Gain information about the enemy and the terrain.

a. **Organization of Forces.** The higher commander will task organize the subordinate units into reconnaissance, fixing, and finishing forces. He will assign specific tasks and purposes to his search and attack forces. Planning considerations for organizing include:

- The factors of METT-TC.
- The requirement for decentralized execution.
- The requirement for mutual support. (The platoon leader must be able to respond to contact with his rifle squads or his mounted sections not in contact, or to mutually support another platoon within the company team.)
- Mounted or dismounted.
- The soldier's load.
- Resupply and CASEVAC.
- The employment of key weapons.
- The requirement for patrol bases.

(1) **Reconnaissance Force.** The size and composition of the reconnaissance force is based on the available information on the size and activity of the enemy operating in the designate AO. The reconnaissance force is typically consists of the task force scout.

However, an infantry platoon may also comprise all or part of the reconnaissance force. The platoon will reconnoiter identified named areas of interest. The platoon leader may also identify fixing and finish elements within the platoon.

(2) **Fixing Force.** The fixing force must have sufficient combat power to isolate the enemy once the reconnaissance force finds him. The fixing force develops the situation once the reconnaissance force finds the enemy. When developing the situation, the fixing force either continues to maintain visual contact with the enemy until the finishing force arrives or conducts an attack to physically fix the enemy until the finishing force arrives. The platoon leader may also identify a finishing element within the platoon.

(a) The platoon maintains visual contact to allow the reconnaissance force to continue to other named areas of interest, and it isolates the immediate area. The fixing force makes physical contact only if the enemy attempts to leave the area or other enemy elements enter the area.

(b) The platoon attacks the enemy if that action meets the commander's intent and if he has sufficient combat power to destroy the enemy.

(3) **Finishing Force.** The finishing force must have sufficient combat power to destroy enemy forces located within the AO. The finishing force must be mobile and responsive enough to engage the enemy before he can break contact with the reconnaissance or fixing forces. A platoon, as the finishing force, may be tasked to conduct the following:

- Destroy the enemy with an attack.
- Block enemy escape routes while another company team conducts the attack.
- Destroy the enemy with an ambush while the reconnaissance or fixing forces drive the enemy toward the ambush location.

b. **Control Measures.** The higher commander will establish control measures that allow for decentralized execution and platoon leader initiative to the greatest extent possible. The minimum control measures for a search and attack are:

- Areas of operation.
- Target reference points.
- Objectives.
- Checkpoints.
- Contact points.

An AO defines the location in which the subordinate units will conduct their searches. A TRP facilitates the responsiveness of the fixing and finishing forces once the reconnaissance force detects the enemy. A TRP also assists in avoiding fratricide in what may be a confusing, noncontiguous environment. Objectives and checkpoints guide the movement of subordinates and help leaders control their organizations. Contact points aid in the coordination among the units operating within the same AO.

Section VI. ATTACK

platoons and squads conduct an attack as part of the company team. An attack requires detailed planning, synchronization and rehearsals to be successful. The company team commander designates platoon objectives with a task and purpose for his assault, support, and breach elements. To ensure synchronization, all leaders must know the location of their subordinates and adjacent units during the attack. In addition to having different

forms based on their purposes (refer to Section VII), attacks are characterized as hasty or deliberate. The primary difference between them is the extent of planning and preparation conducted by the attacking force, but there is no clear distinction between hasty and deliberate attacks. Attacks range along a continuum defined at one end by FRAGOs, which direct the rapid execution of battle drills by forces immediately available. At the other end of the continuum, the platoon has detailed knowledge of the enemy and the terrain, and may be task organized specifically for the attack. Most platoon-level attacks fall somewhere between these two ends of the continuum (Figure 4-5).

		Attack Situations		
		Force-Oriented Moving Enemy	Force-Oriented Stationary Enemy	Terrain-Oriented
Planning Time	Attack Options			
	<ul style="list-style-type: none"> • Attack (hasty) to destroy, disrupt, or block • Counterattack • Spoiling attack • Ambush 	<ul style="list-style-type: none"> • Attack (hasty) to destroy, disrupt, or block] • Counterattack • Feint • Demonstration 	<ul style="list-style-type: none"> • Attack (hasty) to seize, clear, or secure • Counterattack 	
	<ul style="list-style-type: none"> • Attack (deliberate) to destroy, disrupt, or block • Counterattack • Spoiling attack • Ambush • Feint • Demonstration 	<ul style="list-style-type: none"> • Attack (deliberate) to destroy • Raid • Counterattack • Feint • Demonstration 	<ul style="list-style-type: none"> • Attack (deliberate) to seize, clear, or secure • Counterattack 	

Figure 4-5. Attack continuum.

4-23. RECONNAISSANCE

Normally, the platoon leader obtains his information from the company team commander, and then integrates the new information into the plan.

a. Platoons should not conduct reconnaissance unless specifically tasked to in a consolidated reconnaissance plan. If possible, the company team commander should determine the enemy’s size, location, disposition, most vulnerable point, and most probable course of action. At this point, and with permission from battalion, the company team commander should direct the platoon to conduct a reconnaissance patrol. This element conducts a reconnaissance of the terrain along the axis of advance and on the objective. It determines where the enemy is most vulnerable to attack and where the support element can best place fires on the objective.

b. The tentative plan may change as a result of the reconnaissance because the reconnaissance element discovers terrain or enemy dispositions are different than determined during planning. The platoon leader may modify his graphic control measures based on the results of the reconnaissance. For example, the reconnaissance may provide

information that indicates the BFVs could not suppress the enemy from the north side of an objective as originally planned because of terrain limitations. Therefore, the company team commander move the support-by-fire position to the south side of the objective, adjusting the tentative plan to allow the platoon to accomplish its original task and purpose. The platoon leader then refines his plan to properly employ his sections and squads at the new location to accomplish his assigned purpose.

4-24. MOVEMENT TO THE OBJECTIVE

The platoon conducts tactical movement as part of the company team plan under supporting fires using a combination of *traveling*, *traveling overwatch*, and or *bounding overwatch* movement techniques (refer to Chapter 3). The platoon leader transitions the platoon from movement to maneuver at a point either identified by the company team commander during his TLPs, or when the platoon makes contact with the enemy, to reach its objective to support the company team attack. During the movement or maneuver, the company team commander may designate support-by-fire positions to protect friendly forces with direct fires. As the company team maneuvers, it employs fires to destroy, suppress, neutralize and or obscure the enemy positions. If detected early, the platoon concentrates direct and indirect fires, establishing a base-of-fire, and maneuvers to regain the initiative. The BFV platoon conducts most movement to an objective while mounted. If the rifle squads are dismounted and moving separately from the vehicles, leaders must maintain a COP between the mounted sections and the three rifle squads. The platoon leader must consider the following when planning movement to the objective:

- Assembly area to the line of departure.
- Line of departure to the assault position.
- Assault position to the objective.

a. **Assembly Area to the Line of Departure.** The LD is normally a phase line where elements of the attacking force transition to movement techniques in preparation for contact with the enemy.

(1) Before leaving the assembly area, the platoon leader should receive updated information on enemy forces, friendly forces, and the terrain. The platoon leader then disseminates this to the section and squad leaders to keep them abreast of the situation.

(2) The platoon moves forward from the assembly area to the LD, usually as part of a company formation, along a planned, timed, and rehearsed route.

(3) The platoon leader must ensure he crosses the LD at the designated point of departure (PD). He times the move from the assembly area beforehand, so the lead section crosses through the PD at the time of attack. The company team commander will direct if the platoon is to halt in an attack position. If the platoon leader must halt in an attack position, he places the platoon in a coil or herringbone formation, dismounts rifle squads for security, and conducts necessary last minute coordination.

b. **Line of Departure to the Assault Position.** The platoon leader directs the movement of the platoon through checkpoints along the route. During movement, he ensures the platoon navigates from checkpoint to checkpoint or phase line by using basic land navigation skills. The platoon leader ensures his platoon is employing the correct formation and technique for the movement. During movement, the platoon uses cover and concealment (as required) and, if detected, smoke and supporting fires. The platoon

communicates primarily by FM radio. It may also communicate by using hand and arm signals, or flags.

c. **Assault Position to the Objective.** The assault position is the last covered and concealed position prior to reaching the objective. The platoon may move through the assault position at a PLD to begin the assault. The platoon leader may stop in the assault position and designate a PLD between the assault position and the objective.

(1) The platoon leader and company commander must decide whether or not the assault element will assault the objective mounted or dismounted. Generally, if the enemy is in restrictive terrain and poses a significant antiarmor threat, the platoon assaults the objective dismounted. If the objective is on unrestrictive terrain and the enemy's antiarmor threat is minimal, the assault element may assault mounted.

(a) *Mounted Assault.* If the platoon leader decides to assault mounted, then as soon as the BFVs assault across the objective, the rifle squads dismount to clear the objective of enemy forces

(b) *Dismounted Assault.* If the platoon leader decides to assault the objective dismounted, the platoon dismounts its rifle squads to assault the objective, and the BFVs move to support-by-fire positions. If possible, the platoon dismounts in an area that offers some cover and concealment from enemy observation and direct fire, which allows the platoon to assemble and orient appropriately. The dismount point must be close enough to the objective that the infantry squads do not become excessively fatigued while moving to the objective.

(2) Whether assaulting mounted or dismounted, the platoon leader or company team commander designates the dismount point based on the following factors:

- Short of the objective (near or at the assault position).
- On the objective.
- Beyond the objective.

(a) *Short of the Objective.* The advantages of dismounting the rifle squads before reaching the objective include: protection for the squad members while dismounting; better control at the dismount point; and an ability to suppress the enemy with indirect fires without endangering the platoon. The disadvantages include: exposure of the rifle squads to indirect and direct fires as the move toward the objective; and the enemy may target possible dismount points with indirect fires.

(b) *On the Objective.* The advantages of dismounting the rifle squads on the objective include: better platoon speed toward the objective; protection for the rifle squads and the platoon maneuvers toward the objective. The disadvantages include: difficult to orient the rifle squads on specific locations or objectives while riding in the BFV; difficult to control at the dismount point; and the BFVs are vulnerable to short-range, hand-held antiarmor systems while dismounting the rifle squads.

(c) *Beyond the Objective.* Dismounting beyond the objective has several potential advantages: effective control at the dismount point; easier to orient the rifle squads to the terrain and the objective; and confused or disoriented enemy are forced to fight in an unexpected direction. There are also significant disadvantages: the platoon is vulnerable to attack from enemy defensive positions in depth; the platoon is vulnerable to attack by enemy reserve forces; the BFVs are vulnerable to short-range, hand-held antiarmor systems; and it is difficult to control direct fires, increasing the risk of fratricide.

(3) Ideally, the platoon's assault element occupies the assault position without the enemy detecting any of the platoon's elements. Preparations in the assault position may include preparing bangalores, other breaching equipment, or demolitions; fixing bayonets; lifting or shifting direct fires; or preparing smoke pots.

(4) If the platoon is detected as it nears its assault position, indirect fire suppression is required on the objective and the support element increases its volume of fire. If the platoon needs to make any last-minute preparations, then it occupies the assault position. If the platoon does not need to stop, it passes through the assault position, treating it as a PLD and assaults the objective. Sometimes, a platoon must halt to complete preparation and to ensure synchronization of friendly forces. Once the assault element moves forward of the assault position, the assault continues. If the assault element stops or turns back, the element could sustain excessive casualties.

4-25. ISOLATE THE OBJECTIVE

The goals of isolation are to prevent the enemy from reinforcing the objective and to prevent enemy forces on the objective from leaving. Infantry platoons will likely be an isolating force within a company team. If the platoon must isolate its own objective, the platoon leader may use the mounted element to accomplish isolation. The mounted element by its nature is agile, has significant firepower, has protection from small arms fire, and is led by the platoon sergeant. Using the mounted element for this purpose allows the three rifle squads to conduct actions on the objective.

4-26. SEIZE A Foothold AND EXPLOIT THE PENETRATION (ACTIONS ON THE OBJECTIVE)

When conducting the assault across the objectives, a technique is to designate the BFVs, under the platoon sergeant's control, as the mounted support element and to designate the three nine-man rifle squads as the breach and or the assault elements. Platoon internal support elements, employing the M240Bs, should also be considered.

a. As the rifle squads move to the objective, soldiers use individual movement techniques and fire teams retain their basic fire team wedge. The mounted support element begins placing suppressive fires on the objective and monitors the breach and assault elements' movement, and shifts, lifts, or ceases fire according to the plan and the situation.

b. The support (or assault) squad begins placing suppressive fires on the far side of the breach to support the breach element's initial breach of the objective.

c. As the breach is being established, the mounted element should switch from their 25-mm cannon to 7.62-mm coaxial machine guns to allow the breach element to establish a foothold on the objective while avoiding fratricide. To prevent fratricide, supporting direct fire must continue to suppress the enemy, and the platoon leader or platoon sergeant must closely control it. One technique is to mark, either with infrared devices or other visual means, each soldier or just the assault element team on the flank nearest the support element. The assaulting soldiers and the support element sustain a continuous rate of fire to suppress the enemy. When the assault element moves to the breach point, the base-of-fire leader (platoon sergeant) verifies that the assault element is at the right location. He must be able to identify the assault element while it assaults the objective. One section, or designated BFVs, may shift their 25-mm cannon fires to another portion

of the objective. As the breach element is preparing to conduct the breach, the mounted support-by-fire element monitors their progress. This helps the mounted element shift fires as needed. Visual observation is also vital so they can maintain suppressive fires just forward of the breach and assault elements. The assault element (one or two squads) passes through the breach element toward the objective.

d. The mounted element monitors the forward progress of the assault element and keeps shifting suppressive fire at a safe distance in front of them. The breach element should bound forward to provide continual close-in suppressive fire to support the actions of the assault element as it moves across the objective. Once the assault element has seized the initial foothold on the objective, the breach element may then move to the objective to reinforce the assault element.

e. As this occurs, the platoon sergeant closely observes the progress of the breach and assault elements to ensure there is no loss in momentum and that assault and breach elements *do not cross* in front of the mounted support-by-fire line. As the direct fires of the platoon's support element become masked, the platoon leader (or platoon sergeant) shifts, lifts or ceases fire, or he displaces the sections and or weapons to a position where they can continue to support the assault element.

f. All communications from the mounted support element to the breach and assault squads is by FM radio or visual signals. If the mounted element leader observes problems, he radios them to the platoon leader. The platoon leader uses this information in conjunction with what he sees on the objective to control the assault.

NOTE: Even in M2A3-equipped units, leaders should not take the time to type and read digital reports during actions on the objective. Digital reports can be sent when consolidating on the objective.

4-27. CONSOLIDATION AND REORGANIZATION

Once enemy resistance on the objective has ceased, the platoon quickly consolidates to defend against a possible counterattack. The platoon establishes security on or near the objective. The platoon leader assesses and reports the status of ammunition, casualties, and equipment (ACE).

a. **Consolidation.** Consolidation consists of actions taken to secure the objective and defend against an enemy counterattack. The platoon leader determines the most likely enemy avenue of approach based on his assessment of terrain and enemy information. This analysis is conducted before execution of an attack and the enemy's most likely counterattack route is posted on maps and disseminated throughout the platoon. During consolidation, the platoon leader determines if his sections and squads are positioned according to the original plan or to changes in the factors of METT-TC. Once the platoon is positioned to defend against an enemy counterattack, section and squad leaders create sector sketches and submit them to the platoon leader. This information allows the platoon leader to verify the location and orientation of elements when the situation does not allow him to walk the entire security perimeter. As a minimum, section and squad leaders provide the platoon leader with the location and sectors of their key weapons. The platoon leader must use the troop leading procedures to plan and prepare. He ensures the platoon is ready to—

- Eliminate enemy resistance on the objective.

- Establish security beyond the objective by securing areas that may be the source of enemy direct fires or enemy artillery observation.
- Establish additional security measures such as OPs and patrols.
- Prepare for and assist the passage of follow-on forces (if required).
- Continue to improve security by conducting other necessary defensive actions. (These steps, which are outlined in Chapter 5 of this manual, include engagement area development, direct fire planning, and battle position preparation).
- Adjust FPF.
- Secure EPWs

NOTE: The platoon leader and platoon sergeant in M2A3-equipped units must resist the temptation to rely on digital position updates and sector sketches as the sole means of ensuring their defense is established. They *must* walk the perimeter and make on-the-spot adjustments.

b. **Reorganization.** Reorganization, normally conducted concurrently with consolidation, consists of actions taken to prepare for follow-on operations. During reorganization, leaders identify and report losses. Section and squad leaders update their ACE reports. Section leaders also provide information on their fuel status. The platoon sergeant consolidates the reports, updates all platoon status reports, and sends a consolidated platoon report to the company team commander and first sergeant. Based on the information in this consolidated status report, the platoon reorganizes personnel and redistributes ammunition, equipment, and other mission-essential items. As with consolidation, the platoon leader must plan and prepare for reorganization as he conducts his troop leading procedures. He ensures the platoon is prepared to—

- Provide appropriate care and or medical treatment and evacuation of casualties, as necessary.
- Cross-level personnel and adjust task organization as required.
- Conduct resupply operations, including rearming and refueling.
- Redistribute ammunition.
- Conduct required maintenance.
- Reestablish chain of command.

Section VII. SPECIAL PURPOSE ATTACKS

The platoon will conduct a special attack at the direction of the company team commander. The commander will base his decision on the factors of METT-TC. Special purpose attacks are subordinate forms of an attack, they are:

- Ambush.
- Raid.
- Counterattack.
- Spoiling attack.
- Feint.
- Demonstration.

As forms of the attack, they share many of the same planning, preparation, and execution considerations of the offense. Feints and demonstrations are also associated with military deception operations.

4-28. AMBUSH

An ambush is a form of attack by fire or other destructive means from concealed positions on a moving or temporarily halted enemy. It may take the form of an assault to close with and destroy the enemy or it may be an attack-by-fire only, executed from concealed positions. An ambush does not require that ground be seized or held. Ambushes are generally executed to reduce the enemy force's overall combat effectiveness. Destruction is the primary reason for conducting an ambush. Other reasons to conduct ambushes are to harass the enemy, capture the enemy, destroy or capture enemy equipment, and to gain information about the enemy. Ambushes are classified by *category* (deliberate or hasty), *formation* (linear or L-shaped), and *type* (point, area, or antiarmor). The platoon leader uses a combination of category, type, and formation for developing his ambush plan.

a. **Operational Considerations.** The execution of an ambush is offensive in nature; however, the platoon may be directed to conduct an ambush during offensive or defensive operations. The platoon leader considers both mounted and dismounted options for conducting the ambush. The platoon must take all necessary precautions to ensure that it is not detected during movement to or preparation of the ambush site. The platoon must also have a secure route of withdrawal following the ambush. An ambush normally consists of the following actions:

- Mounted (or dismounted) tactical movement to the objective rally point (ORP).
- Reconnaissance of the ambush site.
- Establishment of the ambush security site.
- Preparation of the ambush site.
- Execution of the ambush.
- Withdrawal.

b. **Task Organization.** The platoon is normally task-organized into assault, support, and security forces for execution of the ambush.

(1) **Assault Force.** The assault force executes the ambush. It may employ an attack by fire, an assault, or a combination of those techniques to destroy the ambushed enemy force. The assault force will generally consist of a rifle squad. The platoon leader will normally be located with the assault force.

(2) **Support Force.** The support force fixes the enemy force to prevent it from moving out of the kill zone, allowing the assault force to conduct the ambush. The support force generally uses direct fires in this role, but it may be responsible for calling indirect fires to further fix the ambushed enemy force. The support force will generally consist of a rifle squad with the platoon's M240Bs. The platoon sergeant will normally be located with the support force.

(3) **Security Force.** The security force provides protection and early warning to the assault and support forces and secures the ORP. It isolates the ambush site both to prevent the ambushed enemy force from moving out of the ambush site and to prevent enemy rescue elements from reaching the ambush site. The security force may also be

responsible for securing the platoon's withdrawal route. The security force will generally consist of a rifle squad and the mounted sections. However, the factors of METT-TC may determine that a section or a single BFV be employed in the assault or support forces.

c. **Planning.** The platoon leader's key planning considerations for any ambush include:

- Cover the entire kill zone (engagement area) by fire.
- Use existing (rocks, fallen trees, and so forth) or reinforcing obstacles orienting into the kill zone (Claymores or other mines) to keep the enemy in the kill zone.
- Determine how to emplace reinforcing obstacles on the far side of the kill zone.
- Protect the assault and support forces with mines, Claymores, or explosives.
- Use security force to isolate the kill zone.
- Establish rear security behind the assault force.
- Assault into the kill zone to search dead and wounded, assemble prisoners, and collect equipment. (The assault force must be able to move quickly on its own through protective obstacles.)
- Time the actions of all elements of the platoon to preclude the loss of surprise.
- Determine the role of the BFVs as dictated by the factors of METT-TC.

NOTE: When manning an ambush for long periods of time, the platoon leader may use only one squad to conduct the entire ambush, rotating squads over time. The platoon leader must consider the factors of METT-TC, especially the company team commander's intent and guidance.

d. **Category.** The leader determines the category of ambush through an analysis of the factors of METT-TC. Typically, the two most important factors are time and enemy.

(1) **Deliberate.** A deliberate ambush is a planned offensive action conducted against a specific target for a specific purpose at a predetermined location. The leader requires detailed information on the following when planning a deliberate ambush:

- Size and composition of the targeted enemy unit.
- Weapons and equipment available to the enemy.
- The enemy's route and direction of movement.
- Times that the targeted enemy unit will reach or pass specified points along the route.

(2) **Hasty.** The platoon (or squad) conducts a hasty ambush when it makes visual contact with an enemy force and has time to establish an ambush without being detected. The conduct of the hasty ambush should represent the execution of disciplined initiative within the parameters of the commander's intent. The actions for a hasty ambush should be established in a unit SOP and rehearsed so that soldiers know what to do on the leader's signal.

e. **Formations.** The platoon leader considers the factors of METT-TC to determine the required formation.

(1) **Linear.** In an ambush using a linear formation, the assault and support forces deploy parallel to the enemy's route (Figure 4-6). This positions both forces on the long axis of the kill zone and subjects the enemy to flanking fire. This formation can be used

in close terrain that restricts the enemy's ability to maneuver against the platoon, or in open terrain provided a means of keeping the enemy in the kill zone can be effected.

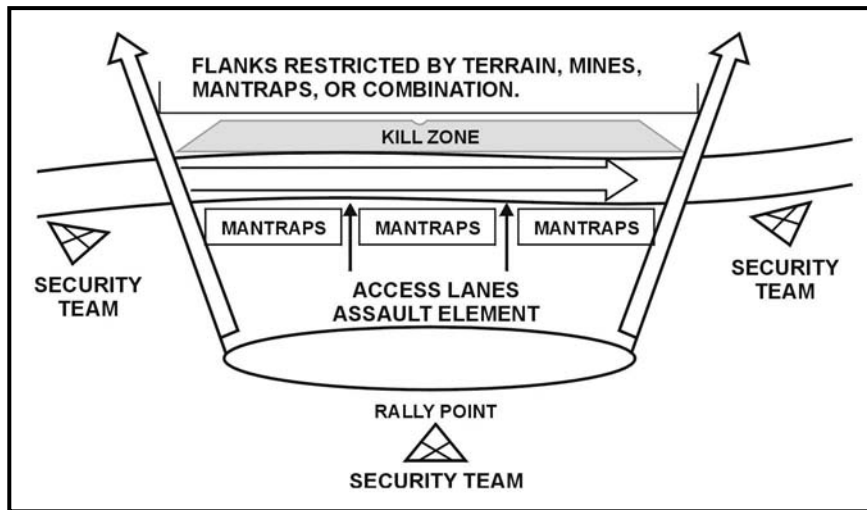

Figure 4-6. Linear ambush formation.

(2) *L-shaped*. In an L-shaped ambush (Figure 4-7), the assault force forms the long leg parallel to the enemy's direction of movement along the kill zone. The support force forms the short leg at one end of and at right angles to the assault force. This provides both flanking (long leg) and enfilading fires (short leg) against the enemy. The L-shaped ambush can be used at a sharp bend in a road, trail, or stream. It should not be used where the short leg would have to cross a straight road or trail. The platoon leader must consider the other factors of METT-TC before opting for the L-shaped formation.

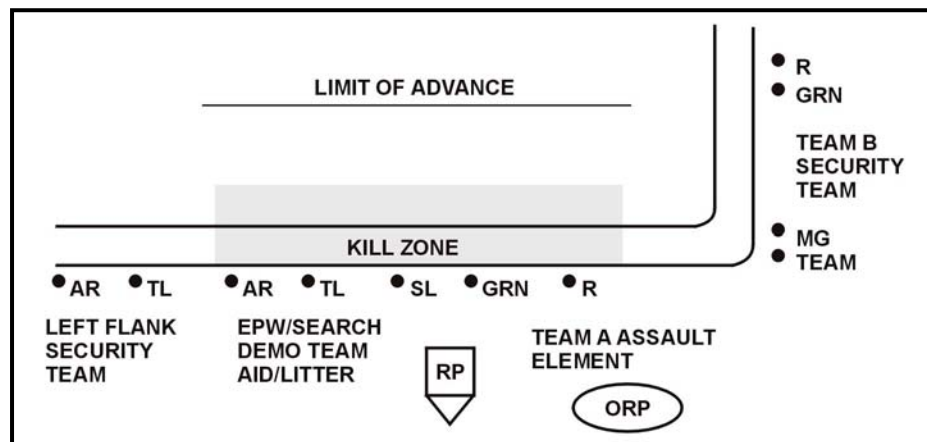

Figure 4-7. L-shaped ambush formation.

f. **Type.** The company team commander, following an analysis of the factors of METT-TC will determine the type of ambush that the platoon will employ.

(1) **Point.** In a point ambush, soldiers deploy to attack an enemy in a single kill zone. The platoon leader should consider the following sequence of actions when planning a point ambush.

(a) The security or surveillance team(s) should be positioned first. The support force should be in position before the assault force moves forward. The support force must overwatch the movement of the assault force into position.

(b) The platoon leader is the leader of the assault force. He must check each soldier once they emplaced. He signals the surveillance team to rejoin the assault force, if it is positioned away from the assault location. If the platoon leader does not employ the BFVs as the security force, the platoon sergeant will likely locate with the platoon leader in the assault force, leaving the mounted sections under the control of the platoon master gunner (Section “A” Leader). The actions of the assault force, support and security force are in Table 4-1.

ASSAULT FORCE	SUPPORT FORCE	SECURITY FORCE
<ul style="list-style-type: none"> • Identify individual sectors of fire assigned by the platoon leader; emplace aiming stakes. • Emplace Claymores and other protective obstacles. • Emplace Claymores, mines, or other explosives in dead space within the kill zone. • Camouflage positions. • Take weapons off SAFE, when directed by the platoon leader. 	<ul style="list-style-type: none"> • Identify sectors of fire for all weapons, especially machine guns • Emplace limiting stakes to prevent friendly fires from hitting the assault force in an L-shaped ambush. • Emplace Claymores and other protective obstacles. • Camouflage positions. 	<ul style="list-style-type: none"> • Identify sectors of fire for all weapons; emplace aiming stakes. • Emplace Claymores and other protective obstacles. • Camouflage positions. • Secure the ORP. • Secure route to ORP, as required.

Table 4-1. Actions by ambush forces.

(c) The platoon leader instructs the security force (or teams) to notify him of the enemy’s approach into the kill zone using the SALUTE reporting format. The security force must also keep the platoon leader informed if any enemy forces are following the lead enemy force, allowing the platoon leader to know if the enemy force meets the engagement criteria directed by the company team commander. The platoon leader must be prepared to let enemy force pass that are too large or do not meet the engagement criteria. He must report to the company team commander any enemy forces that pass through the ambush unengaged.

(d) The platoon leader initiates the ambush with the greatest casualty-producing weapon, typically a command-detonated Claymore. He must also plan a back-up method to initiate the ambush should the primary means fail. This is typically an M240B machine gun. All soldiers in the ambush must know the primary and back-up methods. The platoon should rehearse with both methods to avoid confusion and the loss of surprise during execution of the ambush.

(e) The platoon leader must include a plan for engaging the enemy during limited visibility. Based on the company team commander's guidance, the platoon leader should consider the use and mix of tracers, and the employment of illumination (hand held or indirect fire systems using IR). As little light as possible is preferred. For example, if Javelins are not used during the ambush, the platoon leader may still employ the command launch unit (CLU) with its thermal sights in the security or support force to observe enemy forces.

(f) The platoon leader may also include the employment of indirect fire support in his plan. Based on the company team commander's guidance, the platoon leader may employ indirect fires to: cover flanks of the kill zone to isolate an enemy force; assist the platoon to disengage if the ambush is compromised or must depart the ambush site under pressure.

(g) The platoon leader must have a good plan (day and night) to signal the advance of the assault force into the kill zone to begin its search and collection activities. He should take into consideration the existing environmental factors. For example, smoke may not be visible to the support force because of limited visibility or the lay of the terrain. All soldiers must know and practice relaying the signal during rehearsals.

(h) The assault force must be prepared to move across the kill zone using individual movement techniques if there is any return fire once they begin to search. Otherwise, the assault force moves across by bounding fire teams.

(i) The assault force collects and secures all EPWs and moves them out of the kill zone to an established location before searching bodies. The EPW collection point should provide cover, but should be easily found by enemy forces following the ambush. The assault force searches from far side of the kill zone to the near side, marking bodies that have been searched to ensure thoroughness and speed.

(j) Search teams (two-man teams) approach a dead enemy soldier. One man will guard while the other searches. First, the search man will kick the enemy weapon away. Second, he rolls the body over (if on the stomach) by lying on top and when given the go ahead by the guard (who is positioned at the enemy's head, perpendicular to the search man), the search man rolls the body over on him. This is done for protection in case the enemy soldier has a grenade with the pin pulled or other demolition device underneath him. Third, the search man conducts a systematic search of the dead enemy soldier from head to toe, removing all papers and anything of intelligence value (different type of rank, shoulder board, different unit insignia, pistol, weapon, or other special equipment). The guard annotates all of this information. Finally, once the body has been thoroughly searched, the search team will continue in this manner until all enemy personnel in and near the kill zone have been searched. Enemy bodies should be marked (for example, folded arms over the chest and legs crossed) to avoid duplication of effort.

(k) The platoon identifies and collects equipment to be carried back and prepares it for transport. Weapons are put on safe. The platoon also identifies and collects at a central point the enemy equipment to be destroyed. The demolition team prepares the fuse and awaits the signal to initiate. This is normally the last action performed before departing the ambush site. The flank security force returns to the ORP after the demolition team completes its task. The platoon will treat friendly wounded first then enemy wounded (time permitting).

(l) The flank security teams may also emplace antiarmor mines after the ambush has been initiated if the enemy is known to have armored vehicles that can quickly reinforce the ambushed enemy force. If a flank security team makes contact, it fights as long as possible without becoming decisively engaged. It uses prearranged signals to inform the platoon leader it is breaking contact. The platoon leader may direct a portion of the support force to assist the security force to break contact.

(m) The platoon leader must plan the withdrawal of the platoon from the ambush site. He considers the following:

- Elements normally withdraw in the reverse order that they established their positions.
- Elements may return to the release point, then to the ORP, depending on the distance between the elements.
- The security force at the ORP (this may be the BFVs) must be alert to assist the platoon's return. It maintains security for the ORP while the remainder of the platoon prepares to depart.

(n) Actions back at the ORP include, but are not limited to, accounting for personnel and equipment, stowing captured equipment, first aid (as necessary) and squads remounting the BFVs.

(2) **Area.** In an area ambush, soldiers deploy in two or more related point ambushes. The platoon may conduct an area ambush as part of a company team offensive or defensive plan, or it may conduct a point ambush as part of a company team area ambush. The platoon leader should consider the following sequence of actions when planning an area ambush.

(a) The platoon is the smallest level to conduct an area ambush (Figure 4-8). Platoons conduct area ambushes where enemy movement is largely restricted to trails or streams.

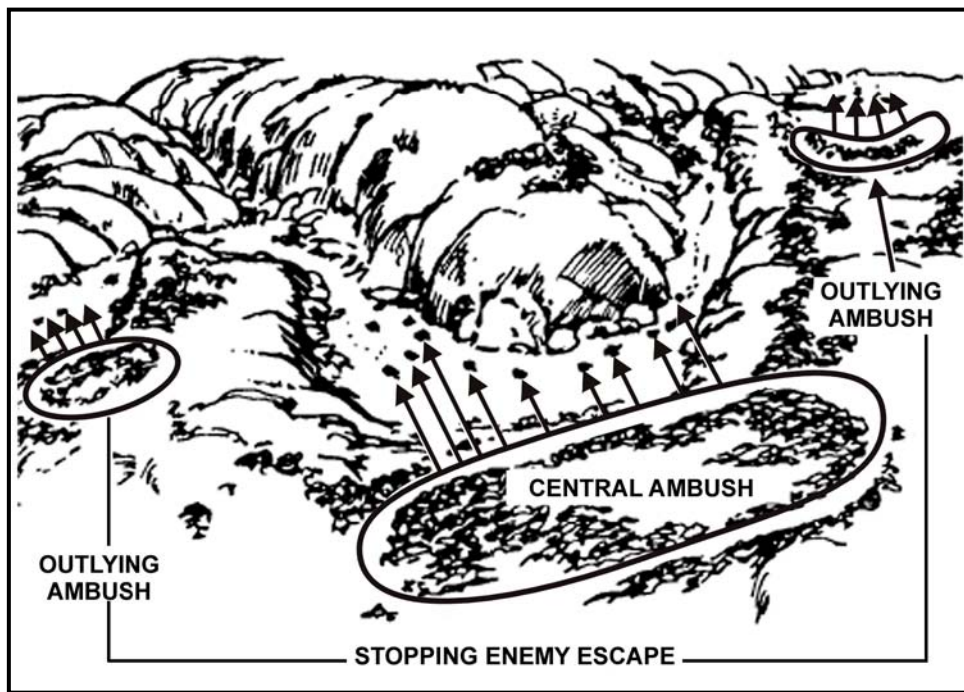

Figure 4-8. Area ambush.

(b) The platoon leader (or company team commander) selects one principal ambush site around which he organizes outlying ambushes. These secondary sites are located along the enemy's most likely avenue of approach to and escape from the principal ambush site. Squads are normally responsible for each ambush site.

(c) The platoon leader considers the factors of METT-TC to determine the best employment of BFVs, machine guns and Javelins. He will normally locate the M240Bs with the support force in the principal ambush site.

(d) Squads (or sections) responsible for outlying ambushes do not initiate their ambushes until the principal one has been initiated. They then engage to prevent enemy forces from escaping the principal ambush or reinforcing the ambushed force.

(3) **Antiarmor.** Platoons and squads conduct antiarmor ambushes (Figure 4-9) to destroy one or two armored vehicles. The ambush may be part of an area ambush. The antiarmor ambush consists of the assault force (armor-killer force) and the support/security force. The leader considers the following when planning an antiarmor ambush.

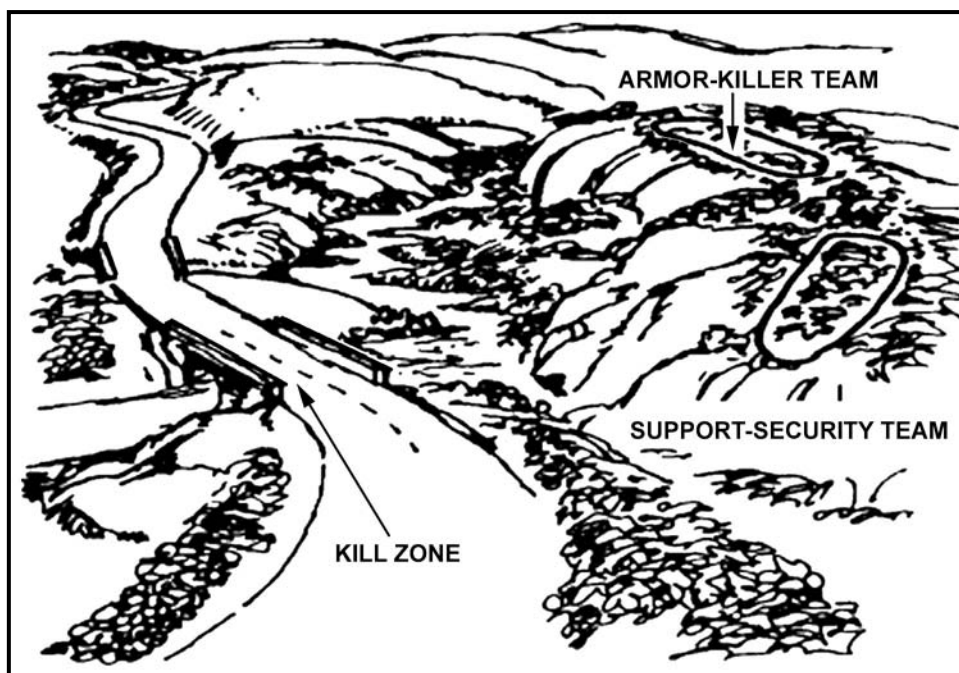

Figure 4-9. Antiarmor ambush.

(a) The armor-killer force is built around the Javelin (or BFV, if employed). The leader should consider additional weapons available to supplement the fires. These may include the light antitank weapon or AT4. The leader considers the factors of METT-TC to position all antiarmor weapons to endure the best engagement (rear, flank, or top). The remainder of the platoon must function as support and security forces in the same manner as the other types of ambushes.

(b) In a platoon antiarmor ambush, the company team commander selects the general site for the ambush. The platoon leader must find a site that restricts the movement of

armored vehicles out of the kill zone. The leader should emplace his weapons so that an obstacle is between them and the kill zone. In a squad antiarmor ambush, the platoon leader selects the general site for the ambush. The squad leader then must find a site that restricts the movement of armored vehicles out of the kill zone.

(c) The support-security forces are emplaced to cover dismounted avenues of approach into the ambush site.

(d) The leader should consider the method for initiating the antiarmor ambush. The preferred method is to use a command-detonated antitank (AT) mine placed in the kill zone. The Javelin can be used to initiate the ambush, but even with its limited signature, it may be less desirable than an AT mine.

(e) The armor-killer team destroys the first and last vehicle in the enemy formation, if possible. All other weapons begin firing once the ambush has been initiated.

(f) The leader must determine how the presence of dismounted enemy soldiers with armored vehicles will affect the success of the ambush. The leader's choices include:

- Initiate the ambush as planned.
- Withdraw without initiating the ambush.
- Initiate the ambush with machine guns without firing antiarmor weapons.

(g) Because of the speed with which enemy armored forces can reinforce the ambushed enemy, the leader should plan to keep the engagement short, and with a quick withdrawal planned. The platoon, based on the factors of METT-TC, may not clear the kill zone as in the other types of ambushes.

4-29. RAID

A raid is a limited-objective form of an attack, usually small-scale, entailing swift penetration of hostile territory to secure information, confuse the enemy, or destroy installations. A raid always ends with a planned withdrawal to a friendly location upon completion of the mission. The platoon can conduct an independent raid (mounted or dismounted) in support of the task force or higher headquarters operation or it can participate as part of the company team in a series of raids. Rifle squads do not execute raids; rather, they participate in a platoon raid.

a. **Operational Considerations.** The platoon may conduct a raid to accomplish a number of missions, including the following:

- Capture prisoners.
- Capture or destroy specific command and control locations.
- Destroy logistical areas.
- Obtain information concerning enemy locations, dispositions, strengths, intentions, or methods of operation.
- Confuse the enemy or disrupt his plans.

b. **Task Organization.** The task organization of the raiding force is determined by the purpose of the operation. However, the raiding force normally consists of the following elements:

- Support force (with the task of support by fire).
- Assault force (with the task of destroy).
- Breach force (if required).

c. **Conduct of the Raid.** The main differences between a raid and other special purpose attacks are the limited objectives of the raid and the associated withdrawal

following completion. However, the sequence of platoon actions for a raid is very similar to those for an ambush. Additionally, the assault element of the platoon may have to conduct a breach of a protective obstacle (if a breach force has not been designated). Raids may be conducted in daylight or darkness, within or beyond the supporting distances of the parent unit. When the location to be raided is beyond supporting distances of friendly lines, the raiding party operates as a separate force. An objective, usually very specific in nature, is normally assigned to orient the raiding unit. During the withdrawal, the attacking force should use a route different from that used to conduct the raid itself.

4-30. COUNTERATTACK

The counterattack is a form of attack by part or all of a defending force against an enemy attacking force, with the general objective of denying the enemy his goal of attacking. This attack by defensive forces regains the initiative or denies the enemy success with his attack. The platoon may conduct a counterattack as lightly committed force within a company team or as the battalion task force reserve. The platoon counterattacks after the enemy begins his attack, reveals his main effort, or creates an assailable flank. As part of a higher headquarters, the platoon conducts the counterattack much like other attacks. However, the platoon leader must synchronize the execution of his counterattack within the overall defensive effort. Counterattacks afford the defender the opportunity to create favorable conditions for the commitment of combat power. The platoon should rehearse the counterattack and prepare the ground to be traversed. Counterattacks are more useful to the higher headquarters when the platoon anticipates employment, plans and prepares for employment, and executes with the other defending, delaying, or attacking forces in conjunction with the higher commander's plan.

4-31 SPOILING ATTACK

A spoiling attack is a form of attack that preempts or seriously impairs an enemy attack while the enemy is in the process of planning or preparing to attack. The purpose of a spoiling attack is to disrupt the enemy's offensive capabilities and timelines while destroying his personnel and equipment. The purpose is not to secure terrain or other physical objectives. A commander (company or battalion) may direct a platoon to conduct a spoiling attack during friendly defensive preparations to strike the enemy while he is in assembly areas or attack positions, preparing for his own offensive operation. The platoon leader plans for a spoiling attack as he does for other attacks. The reasons for conducting a spoiling attack include:

- Disrupt the enemy's offensive preparations.
- Destroy assets that the enemy requires to attack (fire support systems, logistic resupply points, or engineering equipment).
- Gain additional time for the defending force to prepare positions.

4-32 FEINT

A feint is a form of attack used to deceive the enemy as to the location and time of the actual operation. Feints attempt to deceive the enemy and induce him to move reserves and shift his fire support to locations where they cannot immediately impact the actual operation. When directed to conduct a feint, the platoon seeks direct fire (or physical)

contact with the enemy, but avoids decisive engagement. The commander (company or battalion) will assign the platoon an objective limited in size or scope. The planning, preparation, and execution considerations are the same as the other forms of attack. The enemy must be convinced that the feint is the actual attack.

4-33. DEMONSTRATION

A demonstration is a form of attack designed to deceive the enemy as to the location or time of the actual operation by a display of force. Demonstrations attempt to deceive the enemy and induce him to move reserves and shift his fire support to locations where they cannot immediately impact the actual operation. When directed to conduct a demonstration, the platoon does not seek physical contact with the enemy. The planning, preparation, and execution considerations are the same as the other forms of attack. It must appear to be an actual impending attack.

Section VIII. OFFENSIVE TACTICAL TASKS

Tactical tasks consist of specific activities performed by platoons while they conduct tactical operations and maneuvers. At the platoon level, these tasks are the war-fighting actions the platoon might be called on to perform in battle. This section discusses and provides examples of five high-frequency offensive tactical tasks.

NOTE: The situations used in this section to describe the platoon role in the conduct of tactical tasks are examples only. They will not be applicable in every tactical operation, nor are they intended to prescribe any specific method or technique the platoon must use in achieving the purpose of the operation. Ultimately, it is up to the leader on the ground to apply the principles discussed here, along with his knowledge of the situation (including his unit's capabilities, the enemy he is fighting, and the ground on which the battle is taking place), in developing the "correct" solution to the tactical problem.

4-34. SEIZE

Seizing an objective is complex and entails closure with the enemy, under fire of his weapons, to the point that the assaulting force gains positional advantage over or destroys the enemy.

a. A platoon may seize prepared or unprepared enemy positions from either an offensive or defensive posture. Examples include:

- A platoon seizes the far side of an obstacle as part of a company team breach.
- A platoon seizes a portion of an enemy defense as part of a company team deliberate attack.
- A platoon seizes key terrain to prevent its use by the enemy.

b. There are many inherent dangers in seizing an objective: deadly enemy fires; a rapidly changing operational environment; the requirement to execute a dismounted assault; the possibility of fratricide when friendly forces converge. Taken together, these factors dictate that the platoon leader and subordinate leaders understand the following planning considerations.

(1) Developing a clear and current picture of the enemy situation is very important. The platoon may seize an objective in a variety of situations, and the platoon leader will often face unique challenges in collecting and disseminating information on the situation. For example, if the platoon is the seizing force during a company team deliberate attack, the platoon leader may be able to develop an accurate picture of the enemy situation during the planning and preparation for the operation. He can concentrate on developing thorough FRAGOs to issue new information to the platoon as needed.

(2) In another instance, the platoon leader may have to develop his picture of the enemy situation during execution. He must rely more heavily on reports from units in contact and on his own development of the situation. In this type of situation, such as when the platoon is seizing an enemy CSOP during a movement to contact, the platoon leader must plan on relaying information as it develops. He uses clear, concise FRAGOs to explain the enemy situation and give directives to subordinates. He must know how to develop and issue these orders quickly under the pressures of the battlefield environment.

(3) In either type situation, the platoon leader and his subordinate leaders must be adaptive and make necessary adjustments to the scheme of maneuver based on the available information. This will help to ensure they overcome the enemy they will actually face on the ground and not based on a templated enemy force.

(4) Seizing an objective entails closure with the enemy to gain positional advantage over him, control the terrain and to remove all enemy forces or eliminate organized resistance. In some situations, closure may require the platoon to conduct mounted maneuver and dismount the rifle squads on the objective to seize it. In other cases, the platoon may have to use both mounted and dismounted maneuver to gain the advantage and seize the objective. Factors influencing the platoon leader's decision whether to conduct a mounted assault or one combining mounted and dismounted elements to seize the objective include the following.

(a) *Mission Analysis.* The company team commander's intent and concept will likely drive how the platoon maneuvers to the objective. If the platoon is directed to seize an objective area, and the enemy has dismounted positions, the platoon's assault will probably entail both mounted and dismounted maneuver. On the other hand, if the platoon is directed to seize an objective area, and the enemy has vehicle positions may require the platoon to conduct the assault using only mounted forces and dismount the rifle squads on the objective in order to achieve its assigned task and purpose.

(b) *Trafficability of the Objective Area.* If all or part of the objective area is not trafficable by the BFVs, the platoon leader may consider conducting a dismounted assault with the rifle squads, assessing both existing obstacles (severely restricted terrain) and reinforcing obstacles (such as minefields or entrenchments).

(c) *Enemy Antitank Capabilities.* The presence of antitank assets on or around the objective will put the BFVs at risk. The preferred COA is to destroy or suppress the enemy's antitank assets and allow the BFVs to maneuver. If this is not possible, a dismounted assault may be required to eliminate specific antitank threats before, or in conjunction with, a mounted assault.

(d) *Effectiveness of Mounted Direct Fires and Indirect Fires.* If the platoon can effectively destroy enemy assets using mounted direct fires and or indirect fires, it may dismount the rifle squads on the objective.

c. The platoon leader must plan for and implement indirect fire support in his plan.

(1) The company team or platoon uses smoke to isolate the targeted enemy force and to hinder the enemy as he attempts to reposition or reinforce his forces.

(2) The company team or platoon uses suppressive indirect fires to prevent adjacent or reserve enemy elements from engaging the assaulting force.

(3) To protect the approaching assault force, the company team or platoon uses indirect fires to suppress or destroy the enemy on the objective area.

d. While serving as the assault force in a company team deliberate attack, the platoon may have to conduct an assault breach of the enemy's protective obstacles to gain access to the objective area. Protective obstacles are normally integrated with existing obstacles and restricted terrain. The platoon can conduct either a mounted or dismounted assault breach.

(1) The platoon leader decides if the platoon can breach while mounted. He looks at several factors, including terrain and the enemy's antitank capabilities. With favorable terrain, and if the platoon can suppress or destroy enemy antitank systems, the best COA may be a mounted assault breach. He also considers how to best use the firepower and protection of the platoon's BFVs, while preserving the combat power of the platoon's rifle squads.

(2) The dismounted assault breach, also known as a manual breach, is normally slower than the mounted breach and exposes the dismounted rifle squads and or engineers to indirect and direct fires. While planning and preparing, the platoon leader should focus on the tactical considerations and actions that will affect the assault.

e. In most circumstances, the company team sets the conditions for the platoon to seize the objective. The purpose of this effort is to achieve an acceptable superior force ratio for the assaulting platoon. If the platoon is seizing an objective as part of a company team attack, other platoons in the company team will normally be responsible for suppressing the enemy on the objective area from designated support-by-fire positions. These platoons may be the same support forces that protected the breach force. Terrain factors may require them to reposition to provide effective support for the assault force. If the platoon is seizing an objective that is not part of a company team deliberate attack it may have to establish its own support-by-fire positions to suppress the enemy and protect its assault force. Regardless of who provides support-by-fire (another platoon or internal elements), the platoon must always integrate the principles of fire and movement (maneuver) when executing the assault.

f. The platoon normally uses an assault position; the last covered and concealed position short of the objective, when the platoon is the assault force in a company team deliberate attack. It can use an assault position along with a PLD, or it may use a PLD in lieu of an assault position. Actions at the assault position or the PLD could include these critical functions:

- Verify current friendly and enemy situations using tactical reports from platoon or company team support-by-fire forces.
- Issue FRAGOs and disseminate information to the lowest level.
- Confirm TRPs and direct-fire responsibilities.
- Position field artillery observers.
- Conduct final prepare-to-fire checks.
- Reorganize to compensate for combat losses.

4-35. CLEAR

The platoon may be tasked with clearing an objective area during an attack to facilitate the movement of the remainder of the company team, or the platoon may be assigned clearance of a specific part of a larger objective area. Mechanized infantry platoons are normally best suited to conduct clearance operations, which in many cases will involve working in restricted terrain. Situations in which the platoon may conduct the clearance tactical task include the following (refer to FM 3-06.11 for a detailed discussion of urban combat):

- Clearing a defile, including choke points in the defile and high ground surrounding it.
- Clearing a heavily wooded area.
- Clearing a built-up or strip area.
- Clearing a road, trail, or other narrow corridor, which may include obstacles or other obstructions on the actual roadway as well as in the surrounding wooded and built-up areas.

a. **General Terrain Considerations.** The platoon leader must consider several important terrain factors in planning and executing the clearance task.

(1) Observation and fields of fire may favor the enemy. To be successful, the attacking force must neutralize this advantage by identifying dead spaces where the enemy cannot see or engage friendly forces. It should also identify multiple support-by-fire positions, which are necessary to support a complex scheme of maneuver covering the platoon's approach, the actual clearance task, and maneuver beyond the restricted terrain.

(2) Cover and concealment are normally abundant for infantry elements, but are scarce for trail-bound vehicles. Lack of cover leaves vehicles vulnerable to ATGM fires.

(3) Obstacles influence the maneuver of any vehicle entering the objective area. The narrow corridors, trails, or roads associated with restricted terrain can be easily obstructed with wire, mines, and log cribs.

(4) Key terrain may include areas dominating the objective area, approaches or exits, as well as any terrain dominating the area inside the defile, wooded area, or built-up area.

(5) Avenues of approach will be limited. The platoon must consider the impact of canalization, and estimate how much time will be required to clear the objective area.

b. **Restricted Terrain Considerations.** Conducting clearance in restricted terrain is both time consuming and resource intensive. During the planning process, the platoon leader evaluates the tactical requirements, resources, and other considerations for each operation.

(1) During the approach, the platoon leader focuses on moving combat power into the restricted terrain and posturing it to start clearing the terrain. The approach ends when the rifle squads complete their preparations to conduct an attack. The platoon leader—

- (a) Establishes support-by-fire positions with the platoon's BFVs.
- (b) Destroys or suppresses any known enemy positions to allow forces to approach the restricted terrain.
- (c) Provides more security by incorporating suppressive indirect fires and obscuring or screening smoke.

(d) Provides support-by-fire for the rifle squads. Prepares to support the rifle squads from their dismount points to where they enter the restricted terrain using—

- High ground on either side of a defile.
- Wooded areas on either side of a trail or road.
- Buildings on either side of a road in a built-up area.
- Movement of rifle squads along axes to provide cover and concealment.

(2) Clearance begins as the rifle squads begin their attack in and around the restricted terrain. Examples of where this maneuver may take place include:

- Both sides of a defile, either along the ridgelines or high along the walls of the defile.
- Along the wood lines parallel to a road or trail.
- Around and between buildings on either side of the roadway in a built-up area.

(3) The following apply during clearance:

(a) The rifle squads clear in concert with the BFVs.

(b) Combat vehicles provide a base-of-fire to protect rifle squads while they clear an area.

(c) The rifle squads stop at a designated point or terrain feature where observation is optimal.

(d) The rifle squads provide a base-of-fire to allow the BFVs to bound to a new support-by-fire position. This cycle continues until the entire area is cleared.

(e) Direct-fire plans should cover responsibility for both horizontal and vertical observation and direct fire.

(f) Rifle squads should clear a defile from the top down and should be oriented on objectives on the far side of the defile.

(g) Dismounted engineers with manual breaching capability should move with the rifle squads. Engineers should also move with the overwatching vehicles to reduce obstacles.

(4) The platoon must secure the far side of the defile, built-up area, or wooded area until the company team moves forward to pick up the fight beyond the restricted terrain. If the restricted area is large, the platoon may be directed to assist the passage of another element forward to continue the clearance operation. The platoon must be prepared to—

- Destroy enemy forces.
- Secure the far side of the restricted terrain.
- Maneuver mounted elements to establish support-by-fire positions on the far side of the restricted terrain.
- Support-by-fire to protect the deployment of the follow-on force assuming the fight.
- Suppress any enemy elements that threaten the company team while it exits the restricted terrain.
- Disrupt enemy counterattacks.
- Protect the obstacle-reduction effort.
- Maintain observation beyond the restricted terrain.
- Integrate indirect fires as necessary.

c. **Enemy Analysis.** Careful analysis of the enemy situation is necessary to ensure the success of clearing. The enemy evaluation should include the following:

- Enemy vehicle location, key weapons, and infantry elements in the area of operations.
- Type and locations of enemy reserve forces.
- Type and locations of enemy OPs
- The impact of the enemy's NBC and or artillery capabilities.

d. **Belowground Operations.** Belowground operations entail clearing enemy trenches, tunnels, basements, and bunker complexes. The platoon's base-of-fire element and the maneuvering rifle squads must maintain close coordination. The BFVs focus on protecting the rifle squads as they clear the trench line or maneuver to destroy individual or vehicle positions. The base-of-fire element normally concentrates on destroying key surface structures (especially command posts and crew-served weapons bunkers) and the suppression and destruction of enemy vehicles. As noted previously, the direct-fire plan (refer to Appendix G) must be thoroughly developed and rehearsed to ensure it will facilitate effective mutual support while preventing fratricide.

(1) The platoon must establish a base-of-fire with its BFVs to allow the rifle squads to dismount and then maneuver or enter the trench line, tunnel, basement, or bunker. The direct-fire plan must be thoroughly developed and rehearsed to ensure it will facilitate effective protection for the infantry while preventing fratricide.

(a) The platoon leader must also consider specific hazards associated with the platoon's weapon systems. An example is the downrange hazard for the dismounted rifle squads created by the discarding petals of the armor-piercing rounds from the platoon's 25-mm cannon. The hazard area for 25-mm armor-piercing rounds extends 30 degrees to the left and right of the gun-target line out to a range of 200 meters.

(b) The use of TOW missiles creates even greater hazards. The TOW backblast forms a 90-degree "cone" that extends 75 meters to the rear of the vehicle firing the missile. Within those 75 meters, the first 50 meters are the danger zone, and the next 25 meters are a caution zone.

(2) The platoon should consider using restrictive fire measures to protect converging forces and other direct-fire control measures, such as visual signals, to trigger the requirement to lift, shift or cease direct fires. Techniques for controlling direct fires during trench, tunnel, basement, and bunker clearance may include attaching a flag to a pole carried by the soldier who follows immediately behind the lead clearing team; using panels to mark cleared bunkers, tunnels and basements; and using visual signals to indicate when to lift or shift fires.

(3) Once the rifle squads enter the belowground area, the combined effects of the platoon's assets place the enemy in a dilemma. Every action the enemy takes to avoid direct fire from the BFVs, such as maintaining defiled positions or abandoning bunker complexes, leaves him vulnerable to attack from the rifle squads maneuvering down the trench. Conversely, when enemy vehicles move to avoid the attacking rifle squads or when the enemy's infantry elements stay in bunkers or command posts, they expose themselves to BFV support fires.

(4) Consolidation consists of actions taken to secure the objective and defend against an enemy counterattack. The platoon leader must plan and prepare for. He ensures the platoon is ready to—

- Eliminate enemy resistance on the objective.
- Establish security beyond the objective by securing areas that may be the source of enemy direct fires or enemy artillery observation.
- Establish additional security measures such as OPs and patrols.
- Prepare for and assist the passage of follow-on forces (if required).
- Continue to improve security by conducting other necessary defensive actions. (These steps, which are outlined in Chapter 6 of this manual, include engagement area development, direct-fire planning, and BP preparation.)
- Adjust the established FPF (if required).
- Protect the obstacle reduction effort.
- Secure EPWs.

(5) Reorganization, normally conducted concurrently with consolidation, consists of actions taken to prepare for follow-on operations. As with consolidation, the platoon leader must plan and prepare for reorganization as he conducts his TLP. He ensures the platoon is prepared to—

- Provide appropriate care and or medical treatment and evacuation of casualties, as necessary.
- Cross-level personnel and adjust task organization as required.
- Conduct resupply operations, including rearming and refueling.
- Redistribute ammunition.
- Conduct required maintenance.

4-36. SUPPRESS

The platoon maneuvers to a position on the battlefield from which it can observe the enemy and engage him with direct and indirect fires. The purpose of suppressing is to prevent the enemy from effectively engaging friendly forces with direct fires or observed indirect fires. To accomplish this, the platoon must maintain orientation both on the enemy force and on the friendly maneuver force it is supporting. During planning and preparation, the platoon leader should consider the following:

- Conduct a line-of-sight analysis during his terrain analysis to identify the most advantageous positions from which to suppress the enemy.
- Plan and integrate direct and indirect fires.
- Determine control measures (triggers) for lifting, shifting or ceasing direct fires (refer to Appendix G).
- Determine control measures for shifting or ceasing indirect fires.
- Plan and rehearse actions on contact.
- Plan for large Class V expenditures, especially 25-mm rounds. (The company team commander and the platoon leader must consider a number of factors in assessing Class V requirements including the desired effects of the platoon direct fires; the composition, disposition, and strength of the enemy force; and the time required to suppress the enemy.)

- Determine when and how the platoon will reload 25-mm ammunition during the fight while still maintaining suppression for the assaulting force.
- Determine how many, if any, of the rifle squads will dismount the BFVs.

4-37. ATTACK BY FIRE

The platoon maneuvers to a position on the battlefield from which it can observe the enemy and engage him with direct and indirect fires at a distance to destroy or weaken a maneuvering enemy force. The platoon destroys the enemy or prevents him from repositioning. The platoon employs long-range fires (25-mm and TOW) from dominating terrain, uses flanking fires, or can take advantage of the standoff range of the unit's weapon systems. The company team commander may designate an attack-by-fire position from which the platoon will fix the enemy. An ABF position is most commonly employed when the mission or tactical situation neither dictates nor supports occupation of the objective; rather, it focuses on destruction or preventing enemy movement. In the offense, it is usually executed by supporting elements. During defensive operations, it is often a counterattack option for the reserve force.

a. When the platoon is assigned an attack-by-fire position, the platoon leader obtains the most current intelligence update on the enemy and applies his analysis to the information. During planning and preparation, the platoon leader should consider the following:

- Conduct a line-of-sight analysis during terrain analysis to identify the most favorable locations to destroy or fix the enemy.
- Conduct direct and indirect fire planning and integration.
- Determine control measures (triggers) for lifting, shifting, or ceasing direct fires.
- Determine control measures for shifting or ceasing indirect fires.
- Plan and rehearse actions on contact.

b. Several other considerations may affect the successful execution of an attack-by-fire. The platoon may be required to conduct an attack against enemy security forces to seize the ground from which it will establish the attack-by-fire position. The initial attack-by-fire position may afford inadequate security or may not allow the platoon to achieve its task or purpose. This could force the platoon to reposition to maintain the desired weapons effects on the enemy force. In addition, because an attack by fire may be conducted well beyond the direct fire range of other platoons, it may not allow the platoon to destroy the targeted enemy force from its initial positions. The platoon may begin to fix the enemy at extended ranges. Additional maneuver would then be required to close with the enemy force and complete its destruction. Throughout an attack-by-fire, the platoon should reposition or maneuver to maintain flexibility, increase survivability, and maintain desired weapons effects on the enemy. It should also employ rifle squads whenever possible to assist mounted sections. Rifle squad support functions may include the following:

- Seize the attack-by-fire position before occupation by mounted sections.
- Augment TOW fires with Javelin fires.
- Provide local security for the attack-by-fire position.
- Execute timely, decisive actions on contact.
- Use maneuver to move to and occupy the attack-by-fire positions.

- Destroy enemy security elements protecting the targeted force.
- Employ effective direct and indirect fires to disrupt, fix, or destroy the enemy force.

4-38. BYPASS

The platoon may bypass an enemy force or obstacle to maintain the momentum of the attack or for another tactical purpose. The platoon leader designates a fixing force to maintain contact with the enemy. The fixing force also helps the remainder of the platoon during the bypass. The bypassing force uses covered and concealed routes and, if possible, moves along bypass routes outside the enemy's direct-fire range.

a. The platoon can also employ smoke to obscure the enemy or to screen the bypassing force's movement. The platoon must conduct adequate route reconnaissance to confirm the feasibility of the bypass. The enemy may deliberately leave a bypass route unguarded to draw attacking forces into kill sacks.

b. Once the rest of the platoon clears the enemy position, the fixing element normally hands the enemy over to a supporting force, breaks contact, and rejoins the platoon. During a company team-level bypass, the platoon may be employed as the fixing force. The fixing platoon may also be attached to the follow-on force.

CHAPTER 5

DEFENSIVE OPERATIONS

Military forces conduct defensive operations only until they gain sufficient strength to attack. Though the outcome of decisive combat derives from offensive actions, leaders often find it is necessary, even advisable, to defend. Once they make this choice, they must set the conditions of the defense for friendly forces to destroy or fix the enemy while they prepare to seize the initiative and return to the offense. A thorough understanding of the commander's intent is especially critical in defensive operations. These operations demand precise integration of combat support and combat service support elements with combat elements, even at the platoon level. The immediate purpose of all defensive operations is to defeat an enemy attack and gain the initiative for offensive operations. The platoon may also conduct the defense to gain time, retain key terrain, facilitate other operations, preoccupy the enemy in one area while friendly forces attack him in another, erode enemy forces at a rapid rate while reinforcing friendly operations, and set the conditions for follow-on forces or follow-on operations.

Section I. CHARACTERISTICS OF THE DEFENSE

The characteristics of the defense (preparation, security, disruption, massing effects, and flexibility) are the planning fundamentals for the BFV infantry platoon. To ensure the success of the defense, the platoon leader must understand the characteristics of the defense and apply troop-leading procedures during planning and preparation of the operation.

5-1. PREPARATION

The defender arrives in the battle area before the attacker. As the defender, the platoon must take advantage of this by making the most of preparations for combat in the available time. By thoroughly analyzing the factors of METT-TC, the platoon leader gains an understanding of the tactical situation and identifies potential friendly and enemy weaknesses.

5-2. SECURITY

The goals of the platoon's security efforts are normally tied to the company team efforts. These efforts include providing early warning, destroying enemy reconnaissance units, and impeding and harassing elements of the enemy main body. The platoon will typically continue its security mission until directed to displace.

5-3. DISRUPTION

Defensive plans vary with the circumstances, but all defensive concepts of the operation aim at disrupting the attacker's synchronization. Counterattacks, indirect fires, obstacles, and the retention of key terrain prevent the enemy from concentrating his strength against

selected portions of the platoon's defense. Destroying enemy command and control vehicles disrupts the enemy synchronization and flexibility.

5-4. MASSING EFFECTS

The platoon must concentrate combat power at the decisive place and time if it is to succeed. He must obtain a local advantage at points of decision. Offensive action may be a means of gaining this advantage. The platoon leader must remember that this refers to the effects of combat power, not just numbers of soldiers and weapon systems.

5-5. FLEXIBILITY

Flexibility is derived from sound preparation and effective command and control. The platoon must be agile enough to counter or avoid the attacker's blows and then strike back effectively. Flexibility results from a detailed analysis of the factors of METT-TC, an understanding of the unit's purpose, and aggressive reconnaissance and surveillance. Supplementary positions on a secondary avenue of approach may provide additional flexibility to the platoon.

Section II. SEQUENCE OF THE DEFENSE

As part of a larger element, the platoon conducts defensive operations in a sequence of integrated and overlapping steps. This section focuses on the following steps within the sequence of the defense:

- Reconnaissance, security operations, and enemy preparatory fires.
- Occupation.
- Approach of the enemy main attack.
- Enemy assault.
- Counterattack
- Consolidation and reorganization.

5-6. RECONNAISSANCE AND SECURITY OPERATIONS AND ENEMY PREPARATORY FIRES

Security forces must protect friendly forces in the main battle area (MBA) and allow them to prepare for the defense. The goals of a security force include providing early warning, destroying enemy reconnaissance elements (within their capability), and possibly disrupting enemy forward detachments or advance guard elements. During this step, the platoon may be attached to a larger element or remain with the parent company team to conduct counter-reconnaissance. Additionally, the platoon conducts security operations as part of the company team defensive plan by conducting patrols or occupying OPs to observe named areas of interest (NAI).

a. During this step, the platoon may be required to provide guides to the passing security force and may be tasked to close the passage lanes. The platoon, as part of a larger force, may also play a role in shaping the battlefield. The task force or brigade commander may position the team to deny likely enemy attack corridors, thus enhancing flexibility and forcing enemy elements into friendly engagement areas.

b. When not conducting security or preparation tasks, the company team, and in turn the platoon, normally will occupy hide positions to avoid possible enemy artillery preparation.

5-7. OCCUPATION

During this step the platoon plans, reconnoiters, and occupies the defensive position. This includes movement from one location to the defensive location and is normally led by a quartering party that clears the defensive position and prepares it for occupation by the company team. The task force establishes security forces, and the remaining forces prepare the defense. To facilitate maximum time for planning, occupying, and preparing the defense, leaders and soldiers at all levels must understand their duties and responsibilities, to include priorities of work (usually covered in the WARNO or by a unit SOP).

a. Occupation and preparation of the defense (see Section IV of this chapter) site is conducted concurrently with the TLP and the development of the engagement area (if required). The platoon occupies defensive positions in accordance with the company team commander's plan and the results of the reconnaissance. To ensure an effective and efficient occupation, each BFV and squad moves to the marker used by the reconnaissance element to mark friendly positions, or a guide leads them in. These tentative positions are entered on the operational graphics. Once in position, each squad leader and BC checks his position location. As the platoon occupies its positions, the platoon leader manages the positioning of each squad and vehicle to ensure they locate IAW the tentative plan. If the platoon leader notes discrepancies between actual positioning of the squads or vehicles and his plan, he makes the corrections. The platoon leader must personally walk the positions to ensure that everyone understands the plan and that the following are in accordance with the plan:

- Weapons orientation.
- Vehicle positions.
- Weapons squads' positions.
- Rifle squads' positions.

Each squad leader ensures he knows the location of the platoon leader and platoon sergeant for command and control purposes.

b. When the occupation is complete, subordinate leaders can begin to develop their sector sketches (Appendix H) based on the basic fire plan developed during the leader's reconnaissance. Positions are improved when the direct fire plan is finalized and proofed. In addition to establishing the platoon's primary positions, the platoon leader and subordinate leaders normally plan for preparation and occupation of alternate, supplementary, and subsequent positions in accordance with the company order. The following are tactical considerations for these positions.

(1) The following characteristics and considerations apply for an alternate position:

- Covers the same avenue of approach or sector of fire as the primary position.
- Is located slightly to the front, flank, or rear of the primary position.
- Is positioned forward of the primary defensive positions during limited visibility operations.
- Normally is employed to supplement or support positions with weapons of limited range, such as dismounted infantry positions.

(2) The following characteristics and considerations apply for a supplementary position:

- Covers an avenue of approach or sector of fire different from those covered by the primary position.
- Occupied based on specific enemy actions.

(3) The following characteristics and considerations apply for a subsequent position:

- Covers the same avenue of approach and or sector of fire as the primary position.
- Is located in depth through the defensive sector.
- Is occupied based on specific enemy actions or conducted as part of the higher headquarters scheme of maneuver.

5-8. APPROACH OF THE ENEMY MAIN ATTACK

As this step begins, the brigade engages the enemy at long range using indirect fires, electronic warfare, and CAS. The goal is to use these assets and disrupting obstacles to shape the battlefield and or to slow the enemy's advance and disrupt his formations, leaving him more susceptible to the effects of CS weapons. As the enemy's main body echelon approaches the task force engagement area, the task force may initiate indirect fires and CAS to weaken the enemy through attrition. At the same time, the brigade's effort shifts to second-echelon forces, depending on the commander's intent. Platoons cease security patrolling and usually bring OPs back into the defense. Friendly forces will occupy their actual defensive positions before the enemy reaches direct fire range. Positions may be shifted in response to enemy actions or other tactical factors.

5-9. ENEMY ASSAULT

During this step, enemy forces attempt to fix friendly forces and complete their assault. During execution of the defense, friendly forces attempt to mass effects of fires to destroy the assaulting enemy. The platoon leader determines if the platoon can destroy the enemy from its assigned positions.

- a. If the answer is YES, the platoon continues to fight the defense.

(1) The platoon leader continues to call for indirect fires as the enemy approaches. The platoon begins to engage the enemy at maximum effective range and attempts to mass fires and initiate them simultaneously to achieve maximum weapons effects. Indirect fires and obstacles integrated with direct fires should disrupt the enemy's formations, channel him toward engagement areas, prevent or severely limit his ability to observe the location of friendly positions, and destroy him as he attempts to breach tactical obstacles.

(2) Leaders control fires using standard commands, pyrotechnics, and other prearranged signals (Appendix G). The platoon increases the intensity of fires as the enemy closes within range of additional weapons. Squad leaders work to achieve a sustained rate of fire from their positions by having buddy teams engage the enemy so that both soldiers are not reloading their weapons at the same time. In controlling and distributing fires, the platoon and squad leaders consider—

- Range to the enemy.
- Priority targets (at what to fire, when to fire, and why).
- Most dangerous or closest targets.

- Shifting to concentrate direct fires either independently or as directed by higher headquarters.
 - Ability of the platoon to engage dismounted enemy with enfilading, grazing fires.
 - Ability of the antiarmor weapons to achieve flank shots against enemy vehicles.
- (3) The enemy closes on the platoon's protective wire.
- Machine guns and squad automatic weapons fire along interlocking principle directions of fire or final protective lines as previously planned and designated. These may include BFV weapon systems or the platoon's M240Bs. Other weapons fire at their designated principle direction of fire (PDF). Grenadiers engage the enemy with M203 grenade launchers in dead space or as the enemy attempts to breach protective wire.
 - The platoon leader requests final protective fires if they have been assigned in support of his positions.
- (4) The platoon continues to defend until it repels the enemy or is ordered to disengage.
- b. If the answer is NO, the platoon leader reports the situation to the company team commander and continues to engage the enemy. He repositions the platoon (or squads of the platoon) when directed by the commander to—
- Continue fires into the platoon sector (engagement area).
 - Occupy supplementary positions.
 - Reinforce other parts of the company team.
 - Counterattack locally to retake lost fighting positions.
 - Withdraw from an untenable position using fire and movement to break contact.

NOTE: The platoon leader does not move his platoon out of position if it will destroy the integrity of the company team defense. All movements and actions to reposition squads and the platoon must be thoroughly rehearsed.

5-10. COUNTERATTACK

As the enemy's momentum is slowed or stopped, friendly forces may counterattack. The counterattack may be launched purely for offensive purposes to seize the initiative from the enemy. In some cases, the purpose of the counterattack will be mainly defensive, for example, to reestablish the FEBA or to restore control of the sector. The company team or platoon may participate in the counterattack as a base-of-fire element or as the counterattack force. This counterattack could be planned or conducted during the battle when opportunities to seize the initiative present themselves through situational understanding.

The platoon must secure its sector by repositioning forces, destroying remaining enemy elements, processing EPWs, and reestablishing obstacles. The company team conducts all necessary CSS functions as it prepares to continue the defense.

5-11. CONSOLIDATION AND REORGANIZATION

The platoon secure its sector and reestablishes the defense by repositioning forces, destroying enemy elements, processing EPWs, and reestablishing obstacles. The platoon conducts all necessary CSS functions as it prepares to continue defending. Squad and team leaders provide ACE reports to the platoon leader. The platoon leader reestablishes the platoon chain of command. He consolidates squad ACE reports and provides the platoon report to the commander. The platoon sergeant coordinates for resupply and supervises the execution of the casualty and EPW evacuation plan. The platoon continues to improve positions. The platoon quickly reestablishes OPs and resumes security patrolling as directed.

a. Consolidation includes organizing and strengthening a position so that it can continue to be used against the enemy. Some platoon consolidation requirements are—

- Adjust other positions to maintain mutual support.
- Reoccupy and repairs positions and prepares for renewed enemy attack.
- Relocate selected weapons to alternate positions if leaders believe that the enemy may have pinpointed them during the attack.
- Repair damaged obstacles and replaces mines (Claymore) and booby traps.
- Reestablish security and communications.

b. Reorganization includes shifting internal resources within a degraded unit to increase its level of combat effectiveness. Some platoon consolidation requirements are—

- Man key weapons, as necessary
- Provide first aid and prepares wounded soldiers for CASEVAC.
- Redistribute ammunition and supplies.
- Process and evacuate EPWs

Section III. BATTLEFIELD OPERATING SYSTEMS PLANNING CONSIDERATIONS

The BOS are a listing of critical tactical activities that provides a means of reviewing preparation and execution. Synchronization and coordination among the BOS are critical for success.

5-12. MANEUVER

Effective weapons positioning enables the platoon to mass fires at critical points on the battlefield and to enhance survivability. The platoon leader must maximize the strengths of the platoon's weapon systems while minimizing its exposure to enemy observation and fires.

a. **Depth and Dispersion.** Dispersing positions laterally and in depth helps protect the force from enemy observation and fires. Platoon positions are established in depth, allowing sufficient maneuver space within each position for in-depth placement of vehicle weapon systems and dismounted infantry elements. Vehicle and infantry fighting positions are positioned to allow massing of direct fires at critical points on the battlefield. Although the factors of METT-TC ultimately determine the placement of weapon systems and unit positions, the following also apply:

- TOW missiles are employed best at a range of 2,500 to 3,750 meters where targets can be tracked for at least 12 seconds.
- BFVs are best employed from flank positions and in positions from which they can destroy lightly armored vehicles and infantry or fix or severely limit the movement of tanks, usually at a range of 2,500 meters or less.
- Infantry rifle squads should be positioned on reverse slopes or in restricted terrain where they cannot be engaged before they take the enemy under fire.
- Infantry rifle squads can supplement the antiarmor fires of tanks and BFVs with Javelin missiles, which have a maximum range of 2,000 meters.
- Infantry rifle squads can retain or deny key terrain if employed in strong points or well-covered positions.
- Infantry rifle squads can protect obstacles or flank positions that are tied into severely restricted terrain.

b. **Flank Positions.** Flank positions enable a defending force to bring direct fires to bear on an attacking force. An effective flank position provides the defender a larger, more vulnerable target while leaving the attacker unsure of the location of the defender. Major considerations for successful employment of a flank position are the defender's ability to secure the flank and his ability to achieve surprise by remaining undetected. Effective direct fire control (Appendix G) and fratricide avoidance measures (Appendix D) are critical considerations when employing flank positions.

c. **Displacement and Disengagement Planning.** Disengagement and displacement are key control measures that allow the platoon to retain its operational flexibility and tactical agility. The ultimate goals of disengagement and displacement are to enable the platoon to maintain standoff range and to avoid being fixed or decisively engaged by the enemy.

(1) **Considerations.** While disengagement and displacement are valuable tactical tools, they can be extremely difficult to execute in the face of a rapidly moving enemy force. In fact, displacement in contact poses great problems and the platoon leader must plan for it thoroughly before the operation. Even then, he must carefully evaluate the situation whenever displacement in contact becomes necessary to ensure that it is feasible and that it will not result in unacceptable personnel or equipment losses. The platoon leader must consider several important factors in displacement planning:

- The enemy situation (for example, an enemy attack with one motorized rifle battalion (MRB) may prevent the platoon from disengaging).
- Disengagement criteria.
- Availability of direct fire to facilitate disengagement by suppressing or disrupting the enemy.
- Availability of cover and concealment, indirect fires, and smoke to assist disengagement.
- Obstacle integration, including situational obstacles.
- Positioning of forces on terrain (such as reverse slopes or natural obstacles) that provides an advantage to the disengaging elements.
- Identification of displacement routes and times that disengagement and or displacement will take place.
- The size of the friendly force available to engage the enemy in support of the displacing unit.

- Location of remount points, the times remount operations will take place, and maneuver considerations for conduct of a remount in contact.

(2) **Disengagement Criteria.** Disengagement criteria dictate to subordinate elements the circumstances under which they will displace to alternate, supplementary, or subsequent defensive positions. The criteria are tied to an enemy action (such as one MRP advancing past PL DELTA) and are linked to the friendly situation (for example, they may depend on whether an overwatch element or artillery unit can engage the enemy). Disengagement criteria are developed during the planning process based on the unique conditions of a specific situation. They should not be part of the unit's SOP.

(3) **Direct Fire Suppression.** The attacking enemy force must not be allowed to bring effective fires to bear on a disengaging force. Direct fires from the base-of-fire element, employed to suppress or disrupt the enemy, are the most effective way to facilitate disengagement. The platoon also may receive base-of-fire support from another element in the company team, but in most cases the platoon will establish its own base of fire. Employing an internal base-of-fire requires the platoon leader to carefully sequence the displacement of his elements.

(4) **Cover and Concealment.** Ideally, the platoon and subordinate elements should use covered and or concealed routes when moving to alternate, supplementary, or subsequent defensive positions. Regardless of the degree of protection the route itself affords, the platoon should rehearse the movement. By rehearsing, the platoon can increase the speed at which it moves and provide an added measure of security. The platoon leader must make a concerted effort whenever time is available to rehearse movement in limited visibility and degraded conditions.

(5) **Indirect Fires and Smoke.** Artillery or mortar fires can be employed to assist the platoon during disengagement. Suppressive fires, placed on an enemy force as it is closing inside the defender's standoff range, will slow the enemy and cause him to button up. The defending force engages the enemy with long-range direct fires, then disengages and moves to new positions. Smoke may be employed to obscure the enemy's vision, slow his progress, or screen the defender's movement out of the defensive positions or along his displacement route.

(6) **Obstacle Integration.** Obstacles should be integrated with direct and indirect fires to assist disengagement. By slowing and disrupting enemy movement, obstacles provide the defender the time necessary for displacement and allow friendly forces to employ direct and indirect fires against the enemy. The modular pack mine system (MOPMS) can be employed in support of the disengagement, either to block a key displacement route once the displacing unit has passed through it or to close a lane through a tactical obstacle. The location of obstacle emplacement depends in large measure on METT-TC factors. An obstacle should be positioned far enough away from the defender that he can effectively engage enemy elements on the far side of the obstacle while remaining out of range of the enemy's massed direct fires.

5-13. FIRE SUPPORT

For the indirect fire plan to be effective in the defense, the unit must plan and execute indirect fires in a manner that achieves the intended task and purpose of each target. Indirect fires serve a variety of purposes in the defense, including—

- Slowing and disrupting enemy movement.

- Preventing the enemy from executing breaching operations at turning or blocking obstacles.
- Destroying or delaying enemy forces at obstacles using massed indirect fires or precision munitions (such as Copperhead rounds).
- Defeating attacks along dismounted avenues of approach with the use of FPF.
- Disrupting the enemy to allow friendly elements to disengage or conduct counterattacks.
- Obscuring enemy observation or screening friendly movement during disengagement and counterattacks.
- Delivering scatterable mines to close lanes and gaps in obstacles, disrupting or preventing enemy breaching operations, disrupting enemy movement at choke points, or separating or isolating enemy echelons.

5-14. MOBILITY, COUNTERMOBILITY, AND SURVIVABILITY

Mobility focuses on the ability to reposition forces, including unit displacement and the commitment of reserve forces. The company team commander's priorities may specify that some routes be improved to support such operations. Countermobility limits the maneuver of enemy forces and enhances the effectiveness of direct and indirect fires. Survivability focuses on protecting friendly forces from the effect of enemy weapon systems.

a. **Mobility.** Initially during defensive preparations, mobility focuses on the ability to resupply, reposition, and conduct rearward and forward passage of forces, supplies, and equipment. Once defensive preparations are complete, the mobility focus shifts to routes from hide positions, and to alternate, supplementary or subsequent positions. The company team commander will establish the priority of mobility effort within the company team. Normally, all or most of the engineer assets will be allocated to the survivability and or countermobility effort during the defense.

b. **Countermobility.** To be successful in the defense, the platoon leader must integrate obstacles into both the direct and indirect fire plans. (Refer to FM 90-7 for additional information on obstacle planning, siting, and turnover.) The platoon is responsible for constructing protective obstacles.

(1) **Tactical Obstacles.** A tactical obstacle is designed or employed to disrupt, fix, turn, or block the movement of the enemy. Platoons typically construct tactical obstacles when directed by the company team commander.

(a) **Disrupting Effects.** Disrupting effects focus a combination of fires and obstacles to impede the enemy's attack in several ways to include breaking up his formations, interrupting his tempo, and causing early commitment of breaching assets. These effects are often the product of situational obstacles such as scatterable mines, and are normally used forward within engagement areas or in support of forward positions within a defensive sector. Normally, only indirect fires and long-range direct fires are planned in support of disrupting obstacles.

(b) **Fixing Effects.** Fixing effects use the combination of fires and obstacles to slow or temporarily stop an attacker within a specified area, normally an engagement area. The defending unit then can focus on defeating the enemy by using indirect fires to fix him in the engagement area while direct fires inflict maximum casualties and damage. If necessary, the defender can reposition his forces using the additional time gained as a

result of fixing the enemy. To fully achieve the fixing effect, direct and or indirect fires must be integrated with the obstacles. The company team commander must clearly specify the size of the enemy unit to be fixed.

(c) *Turning Effects*. Turning effects use the combination of direct and indirect fires, and obstacles to support the company team commander's scheme of maneuver in several ways, including the following:

- Diverting the enemy into an engagement area and exposing his flanks when he makes the turn.
- Diverting an enemy formation from one avenue of approach to another.
- Denying the enemy the ability to mass his forces on a flank of the friendly force.

(d) *Blocking Effects*. Blocking effects use the combination of direct and indirect fires, and obstacles to stop an attacker along a specific avenue of approach. Fires employed to achieve blocking effects are primarily oriented on preventing the enemy from maneuvering. Because they require the most extensive engineer effort of any type of obstacle, blocking effects are employed only at critical choke points on the battlefield. Blocking obstacles must be anchored on both sides by existing obstacles (severely restricted terrain). Direct and or indirect fires must cover the obstacles to achieve the full blocking effect. The company team commander must clearly specify the size of enemy force that he intends to block.

(2) *Protective Obstacles*. Platoons are responsible for coordinating and employing their own protective obstacles to protect their defensive positions. To be most effective, these obstacles should be tied into existing obstacles and FPFs. The platoon may use mines and wire from its basic load or pick up additional assets (including MOPMS, if available) from the engineer Class IV or V supply point. The platoon, through the company team, may also be responsible for any other required coordination (such as that needed in a relief in place), for recovery of the obstacle, or for its destruction (as in the case of MOPMS).

(a) In planning for protective obstacles, the platoon leader must evaluate the potential threat to the platoon position, and employ the appropriate asset. For example, MOPMS is predominately an antitank system best used on mounted avenues of approach, but it does have some antipersonnel applications. Wire obstacles may be most effective when employed on dismounted avenues of approach. FM 90-7 provides detailed planning guidance for the emplacement of protective obstacles.

(b) Protective obstacles are usually located beyond hand grenade range (40 to 100 meters) from a soldier's fighting position, and may extend out 300 to 500 meters to tie into tactical obstacles and existing restricted/severely restricted terrain. The platoon leader should plan protective obstacles in depth and attempt to maximize the effective range of his weapons.

(c) When planning protective obstacles, the platoon leader should consider the amount of time required to prepare them, the resources available after constructing necessary tactical obstacles, and the priorities of work for the soldiers in the platoon.

(3) *Wire Obstacles*. There are three types of wire obstacles (Figure 5-1): protective wire, tactical wire, and supplementary wire.

(a) Protective wire may be a complex obstacle providing all-round protection of a platoon perimeter, or it may be a simple wire obstacle on the likely dismounted avenue of

approach toward a squad position. Command-detonated M18 Claymore mines may be integrated into the protective wire or used separately.

(b) Tactical wire is positioned to increase the effectiveness of the platoon's direct fires. It is usually positioned along the friendly side of a machine gun final protective line (FPL). Tactical minefields may also be integrated into these wire obstacles or be employed separately.

(c) Supplementary wire obstacles are employed to break up the line of tactical wire to prevent the enemy from locating platoon weapons (particularly BFV, Javelin, and M240B) by following the tactical wire.

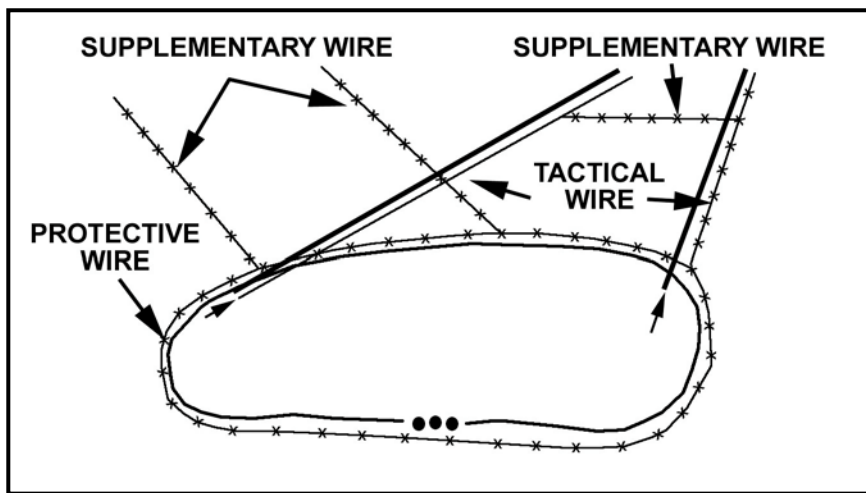

Figure 5-1. Wire obstacles.

(4) **Obstacle Lanes.** The platoon may be responsible for actions related to lanes through obstacles. These duties may include overwatching lanes in the obstacle, marking lanes in an obstacle, reporting the locations of the entry and exit points of each lane, manning contact points, providing guides for elements passing through the obstacle, and closing lanes when directed.

c. **Survivability.** Survivability positions are prepared in defensive positions or strong points to protect vehicles, weapon systems, and the rifle squads. Positions can be dug in and reinforced with overhead cover to provide rifle squads and crew-served weapons with protection against shrapnel from air bursts. Vehicle fighting positions are constructed with both hull-defilade firing positions and turret-defilade observation positions. The company team may use blade assets to dig in ammunition prestocks at platoon alternate, supplementary, or subsequent defensive positions or in individual vehicle fighting positions. The process of digging in a task force requires many "blade hours." Assets may be limited, so the platoon leader must develop a plan for digging in the platoon. He prepares the platoon area for the arrival of the blades by marking vehicle positions and designating guides for engineer vehicles. The platoon leader must prioritize the survivability effort within the platoon. He may have time only to dig in positions that have the least amount of natural cover and concealment. Soil composition should also be a consideration in defensive positions selection; sites to be avoided include those where the soil is overly soft, hard, wet, or rocky.

5-15. AIR DEFENSE

The focus of an air defense plan is on likely air avenues of approach for enemy fixed-wing, helicopters, and unmanned aerial vehicles, which may or may not correspond with the enemy's ground (mounted and dismounted) avenues of approach. A platoon leader will likely not emplace air defense assets; however, he must be aware that higher headquarters may employ air defense assets near his defensive position. (For a detailed discussion of air defense, see Chapter 8, Section III.)

5-16. COMBAT SERVICE SUPPORT

In addition to the CSS function required for all operations (refer to Chapter 9), the platoon leader should consider pre-stocking (otherwise known as pre-positioning or caches). The platoon leader's mission analysis (or guidance from the company team commander) may reveal that the platoon's ammunition needs during an operation may exceed its basic load. This requires the platoon to establish ammunition caches. The caches, which may be positioned at an alternate or subsequent position should be dug in and guarded.

Section IV. ENGAGEMENT AREA DEVELOPMENT

The engagement area (EA) is the place where the platoon leader intends to destroy an enemy force using the massed fires of all available weapons. The success of any engagement depends on how effectively the platoon leader can integrate the obstacle and indirect fire plans with his direct fire plan in the EA to achieve the platoon's purpose. At the platoon level, EA development remains a complex function that requires parallel planning and preparation if the platoon is to accomplish the tasks for which it is responsible. Despite this complexity, EA development resembles a drill. The platoon leader and his subordinate leaders use a standardized set of procedures. Beginning with an evaluation of the factors of METT-TC, the development process covers these steps:

- Identify likely enemy avenues of approach.
- Identify the enemy scheme of maneuver.
- Determine where to kill the enemy.
- Emplace weapon systems.
- Plan and integrate obstacles.
- Plan and integrate indirect fires.
- Conduct an engagement area rehearsal.

5-17. IDENTIFY LIKELY ENEMY AVENUES OF APPROACH

The platoon leader conducts an initial reconnaissance from the enemy's perspective along each avenue of approach into the sector or engagement area. During his reconnaissance, he confirms key and or decisive terrain identified by the company team commander, including locations that afford positions of advantage over the enemy as well as natural obstacles and or choke points that restrict forward movement. He also determines which avenues will afford cover and concealment for the enemy while allowing him to maintain his tempo, and he evaluates lateral mobility corridors (routes) that adjoin each avenue of approach.

5-18. IDENTIFY THE ENEMY SCHEME OF MANEUVER

The platoon leader greatly enhances this step by gaining information early. He receives answers to the following questions from the company team commander:

- Where does the enemy want to go?
- Where will the enemy go based on terrain?
- What is the enemy's mission (or anticipated mission)?
- What are the enemy's objectives?
- How will the enemy structure his attack?
- How will the enemy employ his reconnaissance assets?
- What are the enemy's expected rates of movement?
- How will the enemy respond to friendly actions?

5-19. DETERMINE WHERE TO KILL THE ENEMY

As part of his TLP, the platoon leader must determine where he will mass combat power on the enemy to accomplish his purpose. This decision is tied to his assessment of how the enemy will fight into the platoon's engagement area. Normally this entry point is marked by a prominent TRP that all vehicles in the platoon can engage with their direct fire weapons. This allows the commander to identify where it will engage enemy forces through the depth of the company team engagement area. In addition, the leader—

- Identifies TRPs that match the enemy's scheme of maneuver, allowing the platoon (or company team) to identify where it will engage the enemy through the depth of the engagement area.
- Identifies and records the exact location of each TRP.
- Determines how many weapon systems can focus fires on each TRP to achieve the desired purpose.
- Determines which section or squad can mass fires on each TRP.
- Begins development of a direct fire plan that focuses on each TRP.

NOTE: In marking TRPs, use thermal sights to ensure visibility at the appropriate range under varying conditions, including daylight and limited visibility.

5-20. EMPLACE WEAPON SYSTEMS

To position weapons effectively, leaders must know their characteristics, capabilities, and limitations of the weapons as well as the effects of terrain and the tactics used by the enemy. Platoon leaders should position weapons where they have protection, where they can avoid detection, and where they can surprise the enemy with accurate, lethal fires. In order to position the weapon, the platoon leader must know where he wants to destroy the enemy and what effect he wants the weapon to achieve (For a detailed discussion of weapons positioning refer to Section II of this chapter). Additional considerations are as follows:

- Select tentative section and squad defensive positions.
- Conduct a leader's reconnaissance of the tentative defensive positions.
- Drive the engagement area to confirm that the selected positions are tactically advantageous.

- Confirm and mark the selected defensive positions.
- Ensure the defensive positions do not conflict with those of adjacent units and is effectively tied in with adjacent positions.
- Select primary, alternate, and supplementary fighting positions to achieve the desired effect for each TRP.
- Ensure the section leaders and or squad leaders position weapon systems so the required numbers of weapons, BFVs, and or squads effectively cover each TRP.
- Ensure that positions allow BCs and or gunners to observe the engagement area from the turret-down position and engage enemy forces from the hull-down position.
- Stake vehicle positions in accordance with unit SOP so engineers can dig in the positions while BFV crews perform other tasks.
- Inspect all vehicle positions.

NOTE: When possible, select vehicle positions while moving in the engagement area. Using the enemy's perspective enables the platoon leader to assess survivability of the positions.

5-21. PLAN AND INTEGRATE OBSTACLES

To be successful in the defense, the platoon leader must integrate tactical obstacles with the direct fire plan, taking into account the intent of each obstacle. At the company team level, obstacle intent consists of the target of the obstacle, the desired effect on the target, and the relative location of the group. A platoon must have a clear task and purpose in order to properly emplace a tactical obstacle. Normally, the company team or battalion task force will designate the purpose of the tactical obstacle. The purpose will influence many aspects of the operation, from selection and design of obstacle sites to actual conduct of the defense. Once the tactical obstacle has been emplaced, the platoon leader must report its location and the gaps in the obstacle to the company team commander. This ensures that the company team commander can integrate obstacles with his direct and indirect fire plans, refining his EA development.

5-22. PLAN AND INTEGRATE INDIRECT FIRES

In planning and integrating indirect fires, the platoon leader must accomplish the following:

- Determine the purpose of fires, if the company team commander has not already done so.
- Determine where that purpose will best be achieved if the company team commander has not done so.
- Establish the observation plan with redundancy for each target. Observers will include the platoon leader as well as members of subordinate elements (such as team leaders) with fire support responsibilities.
- Establish triggers based on enemy movement rates.
- Obtain accurate target locations using survey and or navigational equipment.
- Refine target locations to ensure coverage of obstacles.

- Adjust artillery and mortar targets.
- Plan FPF.

5-23. CONDUCT AN ENGAGEMENT AREA REHEARSAL

The purpose of rehearsal is to ensure that every leader and every soldier understands the plan (Figure 5-2) and is prepared to cover their assigned areas with direct and indirect fires.

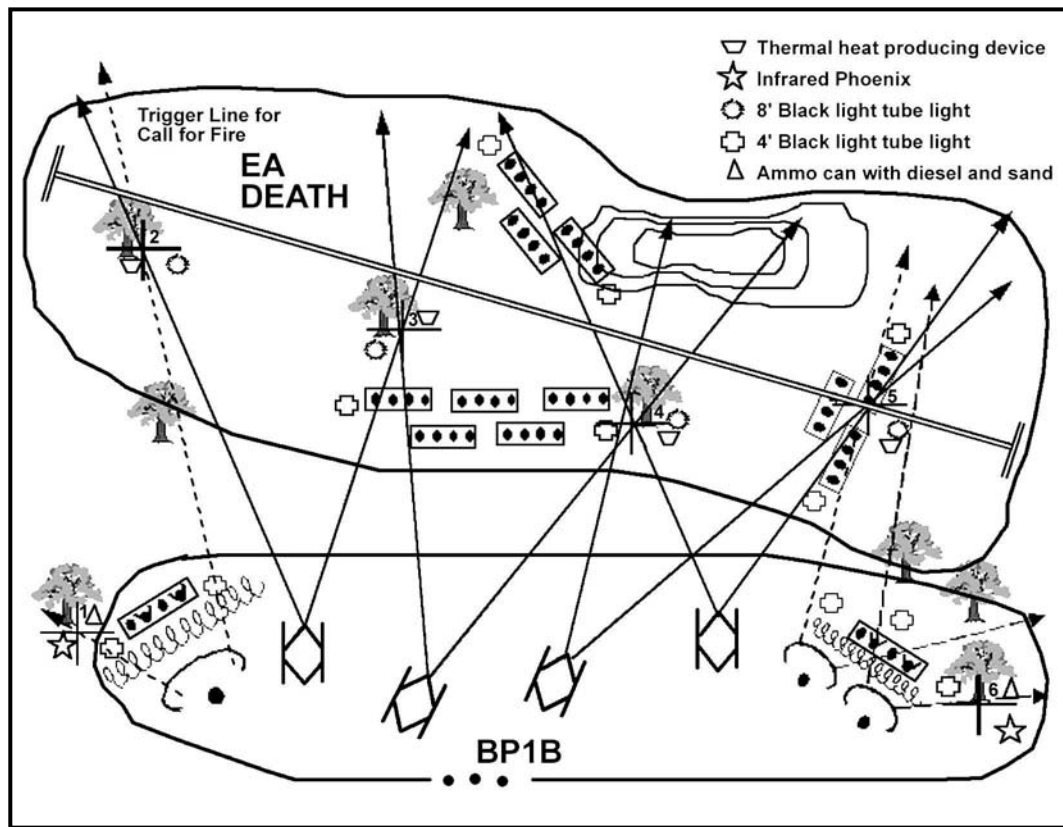

Figure 5-2. Integrated engagement area plan.

The platoon will likely participate in a company level engagement area rehearsal. The company team commander has several options for conducting a rehearsal, but the mounted rehearsal is the most common and most effective. One technique for the mounted rehearsal in the defense is to have the company team trains, under the control of the company team XO, move through the engagement area to depict the enemy force while the commander and subordinate platoons rehearse the battle from the team defensive positions. The rehearsal should cover:

- Rearward passage of security forces (as required).
- Closure of lanes (as required).
- Movement from the hide position to the defensive positions.
- Use of fire commands, triggers, and or MELs to initiate direct and indirect fires.
- Shifting of fires to refocus and redistribute fire effects.

- Disengagement criteria.
- Identification of displacement routes and times.
- Location of remount points, the times remount operations will take place, and movement considerations for conduct of a remount in contact.
- Preparation and transmission of critical reports using FM and digital systems (as applicable).
- Assessment of the effects of enemy weapon systems.
- Displacement to alternate, supplementary, or subsequent defensive positions.
- Cross-leveling or resupply of Class V items.
- Evacuation of casualties.

NOTE: When conducting his own rehearsal, the platoon leader should coordinate the platoon rehearsal with the company team to ensure other units' rehearsals are not planned for the same time and or location. Coordination will lead to more efficient use of planning and preparation time for all company team units. It also will eliminate the danger of misidentification of friendly forces in the rehearsal area.

Section V. OCCUPATION AND PREPARATION OF DEFENSIVE POSITIONS

Occupation and preparation of defensive positions is conducted concurrently with the TLP and EA development. The process is not sequential. The potential problem associated with this process is the lack of adequate preparation time if the platoon has several other defensive positions (alternate, supplementary, and subsequent) and EAs to develop.

5-24. OCCUPATION OF DEFENSIVE POSITIONS

The platoon occupies defensive positions in accordance with the platoon leader's plan and the results of the reconnaissance.

a. To ensure an effective and efficient occupation, each BFV and rifle squad moves to the location marked by the reconnaissance element as a friendly position. These positions are also on the operational graphics. Once in position, each squad leader and BC checks his location on map to ensure he is complying with the platoon leader's graphics. As the platoon occupies its positions the platoon leader ensures that each squad and vehicle locate in accordance with his plan. If the platoon leader notes discrepancies between actual positioning of the squads or vehicles and his plan, he corrects it immediately.

b. Once each BFV and rifle squad has occupied its position, the platoon leader must walk the positions to ensure the weapons orientation, positioning of the BFVs and rifle squads, and understanding of the plan are in accordance with the pre-established plan. The platoon leader should not rely on updates from his subordinates. He always should walk his defensive perimeter. Each squad leader and BC ensure he knows the location of the platoon leader and platoon sergeant for command and control purposes.

c. Own-the-night (OTN) equipment enhances the occupation process under limited visibility conditions. For instance, the platoon leader can mark his position with an infrared light source and the squad leaders and BCs can move to pre-marked positions

with infrared light sources showing them where to locate. Additionally, the squad leaders can use AN/PAQ-4B/Cs or AN/PEQ-2As to point out sectors of fire and TRPs to their soldiers, using infrared light sources to keep the occupation clandestine.

d. The platoon may conduct a hasty occupation in the defense during a counterattack or after disengagement and movement to alternate, supplementary, or subsequent defensive positions.

(1) The platoon leader issues a FRAGO covering the following minimum information:

- Changes in the enemy and or friendly situation
- The platoon task and purpose (what the platoon must accomplish and why).
- The task and purpose for each subordinate element.
- The scheme of fires.
- Coordinating instructions.

(2) At a minimum the following actions must be taken:

- The platoon approaches the defensive positions from the rear or flank.
- The platoon establishes direct fire control measures or, if these are preplanned, reviews the plan.
- The platoon leader reports “OCCUPIED” to the company team commander.

e. The platoon conducts deliberate occupation of defensive positions when time is available, when enemy contact is not expected, and when friendly elements are positioned forward in the sector to provide security for forces in the MBA. Actually establishing defensive positions is accomplished concurrently with the development of the EA. The platoon leader directs the initial reconnaissance from the EA and then tentatively emplaces vehicle and weapon system positions.

f. Once the defensive positions are established, subordinate leaders can begin to develop their sector sketches and fire plans based on the basic team fire plan developed during the leader’s reconnaissance. BFV positions are improved while the direct fire plan is finalized and proofed. Depending on factors of METT-TC, the platoon may occupy hide positions when preparations are completed, then occupy the defensive positions just before initiating the defensive operation. The platoon leader, with guidance from the company team commander, designates the level of preparation for each defensive position based on the time available and other tactical considerations for the mission. The three levels of defensive position preparation are listed here in descending order of thoroughness and time required:

(1) **Occupy**. Complete the preparation of the position from which the platoon will initially defend. The position is fully reconnoitered, prepared, and occupied prior to the “defend NLT” time specified in the company team order. The platoon must rehearse the occupation, and the platoon leader must establish a trigger for occupation of the position.

(2) **Prepare**. The position and the corresponding EA will be fully reconnoitered. Squad and BFV positions in the defensive positions should be marked, along with direct fire control measures in the EA. Survivability positions may be dug, ammunition caches pre-positioned, and protective obstacles emplaced.

(3) **Reconnoiter**. Both the EA and defensive positions will be fully reconnoitered. Tentative weapon positions should be planned in the defensive positions, and limited direct fire control measures should be established in the engagement area.

g. In addition to establishing the platoon's primary defensive positions, the platoon leader and subordinate leaders normally plan for preparation and occupation of alternate, supplementary, and subsequent defensive positions in accordance with the company team order.

(1) The following characteristics and considerations apply for an alternate defensive position:

- Covers the same avenue of approach and or sector of fire as the primary defensive positions; located slightly to the front, flank, or rear of the primary defensive positions.
- Positioned forward of the primary defensive positions during limited visibility operations.
- Normally employed to supplement or support positions with weapons of limited range, such as dismounted infantry positions.

(2) The following characteristics and considerations apply to a supplementary defensive position:

- Covers an avenue of approach and or sector of fire different from those covered by the primary defensive positions.
- Occupied based on specific enemy actions.

(3) The following characteristics and considerations apply for a subsequent defensive position:

- Covers the same avenue of approach and or sector of fire as the primary defensive position; located in depth through the defensive sector.
- Occupied based on specific enemy actions or conducted as part of the higher headquarters scheme of maneuver.

5-25. PRIORITY OF WORK

Leaders must ensure that soldiers prepare for the defense quickly and efficiently. Work must be done in priority to accomplish the most in the least time while maintaining security and the ability to respond to enemy action. Below are basic considerations for priorities of work.

- Emplace local security (leaders).
- Position and assign sectors of fire for each BFV (platoon leader).
- Position and assign sectors of fire for Javelin and machine gun (M240) teams (platoon leader).
- Position and assign sectors of fire for M249 gunners, grenadiers, and then riflemen (squad leaders).
- Clear fields of fire and prepare range cards.
- Prepare and sector sketches (leaders).
- Dig fighting positions (stage 1).
- Establish communications with the company team and adjacent units.
- Coordinate with adjacent units; review sector sketches.
- Emplace antitank and Claymore mines, then wire and other obstacles.
- Improve primary fighting positions and add overhead cover (stage 2).

- Prepare supplementary and then alternate positions (same procedure as the primary position).
- Distribute and stockpile ammunition, food, and water.

Unit priorities of work are normally found in SOPs; however, the commander will dictate the priorities of work for the company team based on the factors of METT-TC. Several actions may be accomplished at the same time. Leaders must constantly supervise the preparation of fighting positions, both for tactical usefulness and proper construction.

5-26. SECURITY IN THE DEFENSE

Security in the defense includes all active and passive measures taken to avoid detection by the enemy, deceive the enemy, and deny enemy reconnaissance elements accurate information on friendly positions. The two primary tools available to the platoon leader are observation posts and patrols. In planning (refer to Chapter 2, Section III) for the security in the defense, the platoon leader considers the terrain in terms of OCOKA. He uses his map to identify terrain that will protect the platoon from enemy observation and fires while providing observation and fires into the EA. Additionally, he uses intelligence updates to increase his situational understanding, reducing the possibility of the enemy striking at a time or in a place for which the platoon is unprepared.

NOTE: Updates in M2A3-equipped platoons occur when the task force transmits the enemy updates over the battalion task force ASAS-RWS or the MCS to the company team commander, and the commander forwards this enemy information to the platoons over FBCB2.

a. **Observation Posts.** An OP gives the platoon its first echelon of security in the defense. The OP provides early warning of impending enemy contact by reporting direction, distance, and size. It detects the enemy early and sends accurate reports to the platoon. The OP renders reports are by FM radio transmissions. The platoon leader establishes OPs along the most likely enemy avenues of approach into the position or into area of operation. Leaders ensure that OPs (mounted or dismounted) have communication with the platoon.

NOTE: In an M2A3-equipped platoon, mounted OPs may render reports digitally. The OP sends these reports without violating noise discipline because the information is written and the receiving station is less likely to misinterpret the report. Dismounted OPs still render reports by FM radio transmission.

(1) Early detection reduces the risk of the enemy overrunning the OP. OPs may also be equipped with a Javelin CLU to increase its ability to detect the enemy. They may receive infrared trip flares, infrared parachute flares, infrared M203 rounds, and even infrared mortar round support to illuminate the enemy. The platoon leader weighs the advantages and disadvantages of using infrared illumination when the enemy is known to have night vision devices that detect infrared light. Although infrared and thermal equipment within the platoon enables the platoon to see the OP at a greater distance, the OP should not be positioned outside the range of the platoon's small-arms weapons.

(2) To further reduce the risk of fratricide, OPs use GPS, if available, to navigate to the exit and entry point in the platoon's position. The platoon leader ensures he submits OP locations to the company team commander to ensure a no fire area (NFA) is established around each OP positions. The commander sends his operational overlay with OP positions to the task force and to adjacent units and receives the same type overlay from adjacent units to assist in better command and control and fratricide avoidance (Appendix D). The platoon leader confirms that the company team FIST has forwarded these locations to the task force FSO and has received the appropriate NFAs on the fire support graphics.

b. **Patrols.** Platoons actively patrol in the defense. Patrols enhance the platoon's ability to fill gaps in security between OPs (refer to Chapter 7). The platoon leader forwards his tentative patrol route to the commander to ensure they do not conflict with other elements within the company team. The commander forwards the entire company team's patrol routes to the task force. This allows the task force S3 and S2 to ensure all routes are coordinated for fratricide prevention and to ensure the company team and platoons are conforming to the task force intelligence, surveillance, and reconnaissance (ISR) plan. The patrol leader may use a GPS to enhance his basic land navigational skills as he tracks his patrol's location on a map, compass, and pace count or odometer reading.

5-27. ESTABLISHMENT OF DEFENSIVE POSITIONS

Platoons establish defensive positions in accordance with the platoon leader and commander's plan. They mark EAs using marking techniques prescribed by unit SOP. The platoon physically marks obstacles, TRPs, targets, and trigger lines in the EA. During limited visibility the platoon can use infrared light sources to mark TRPs for the rifle squads. The mounted force must have heated (thermal signature) TRPs in addition to the infrared devices to orient their weapons. When possible, platoons should mark TRPs with both a thermal and infrared source so both the BFVs and rifle squads can use the TRP.

a. **Range Card.** A range card is a sketch of a sector that a direct fire weapon system is assigned to cover. A range card aids in planning and controlling fires and aids the crew in acquiring targets during limited visibility. It is also an aid for replacement personnel or platoons or squads to move into the position and to orient on their sector. During good visibility, the gunner should have no problems maintaining orientation in his sector. During poor visibility, he may not be able to detect lateral limits. If the gunner becomes disoriented and cannot find or locate reference points or sector limit markers, he can use the range card to locate the limits. The gunner should make the range card so that he becomes more familiar with the terrain in his sector. He should continually assess the sector and if necessary update his range card. (For a detailed discussion of range cards refer to Appendix H.)

NOTE: In M2A3-equipped units, individual soldiers still prepare handwritten range cards for their positions since they do not have the capability to enter this data into FBCB2.

b. **Firing Position.** After a range card has been completed, the position should be marked with ground stakes. This enables the Bradley or a replacement Bradley to reoccupy the position and be able to use the range card data.

(1) **Stake the Position.** Before the Bradley is moved, the position should be staked. Three stakes are required to effectively mark the position as shown in Figure 5-3.



Figure 5-3. Stake the position.

(a) One stake is placed in front of the BFV, centered on the driver's station and just touching the hull. The stake should be long enough for the driver to see it when in position. The other two stakes are placed parallel to the left track and lined up with the hub on the front and rear wheels. The stakes should be placed close to the Bradley with only enough clearance to move the Bradley into position.

(b) The stakes should be driven firmly into the ground. Engineer tape or luminous tape can be placed on the friendly side of the stakes so that the driver can see them. A rock is placed at each of the front two corners of the vehicle to assist in reoccupation if the stakes are lost.

(2) **Move into Position.** If the situation permits, a ground guide can be used to assist the driver. If a ground guide cannot be used, the driver moves the BFV in, parallel to the side stakes, with the front stake centered on the driver's station. Once the BFV is in position, the gunner should index the range and azimuth for one of the TRPs on the range card. If the sight is aligned on the TRP, the Bradley is correctly positioned. If the sight is not aligned on the TRP, the gunner should tell the driver which way to move the vehicle to align the sight on the target. Only minor adjustments should be necessary. If the stakes are lost and the position is not otherwise marked, the vehicle is moved to the approximate location. The BC or gunner can use a compass to find the left and right limits. The vehicle should be moved if time allows until it is within 6 to 8 inches of exact position.

c. **Sector Sketches.** Detailed sketches aid in the planning, distribution, and control of the platoon fires. Gunners prepare the range cards. Squad leaders prepare squad sector sketches, section leaders prepare section sketches, and the platoon leader prepares the platoon sketch. (For a detailed discussion of sector sketches refer to Appendix H)

NOTE: In M2A3-equipped units, leaders still prepare handwritten sector sketches for their positions since they do not yet have a tool (sketch card) to enter this data into FBCB2. However, leaders may use the overlay tool to mitigate the absence of a sketch card tool.

5-28. WEAPONS PLACEMENT

To position weapons effectively, leaders must know the characteristics, capabilities and limitations of the weapons, the effects of terrain, and the tactics used by the enemy. Platoon leaders should position weapons where they have protection; avoid detection; and surprise the enemy with accurate and lethal direct fires. In order to position the weapon, the platoon leader must know where he wants to destroy the enemy and what effect he wants the weapon to achieve. Additionally, the platoon leader must consider whether his primary threat will be armored vehicles or infantry. His plan should address both mounted and dismounted threats.

a. **Individual BFVs.** Leaders should position BFVs where flank engagements will occur. This means placing fighting positions on the flank of enemy mounted avenues of approach.

(1) BFVs use defilade positions when in the defense. Defilade positions are classified as either turret-down or hull-down. A turret-down position uses terrain to mask most of the BFV, with only the ISU (or IBAS) exposed to the enemy. Because the TOW, when erected, is above the ISU, it may be fired from this position without exposing more of the BFV than necessary as long as the missile has 18 inches of clearance. The BFV cannot engage the enemy with the 25-mm from this position. A hull-down position exposes only as much of the BFV as needed to engage the enemy with the three primary weapon systems.

(2) Flank positions (Figure 5-4) in restrictive terrain provide windows of opportunity to engage the enemy and afford the BFV additional protection from enemy overwatching fire. The basis for this technique is to limit exposure only to the targets at which it is firing. It then shifts to other firing positions as enemy vehicles are destroyed. These positions restrict observation and vulnerability to only one segment of the platoon's engagement area; therefore, only those enemy vehicles that can be seen (and engaged) by the BFV can return fire.

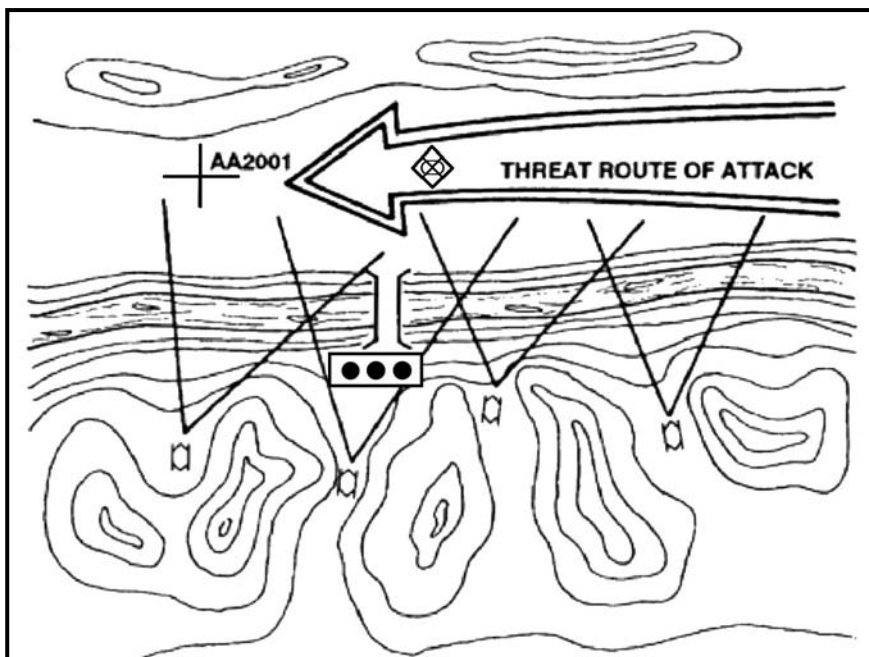

Figure 5-4. Flank positions.

(3) Leaders should consider the following when employing BFVs in the defense:

- Use a hide position when possible and stay in it until the enemy is in the area where the platoon will destroy him. A prone or dug-in observer forward gives a much smaller signature than a BFV
- Have a backdrop and avoid anything that may catch the enemy's eye.
- Position to the flank of an enemy mounted approach and behind frontal cover. It is easier for the attacker to acquire and destroy a target to his front than those to his flank or rear.
- Use covered routes into and out of firing positions.
- Use a guideline of 75 meters or more between primary and alternate BFV positions. This decreases the enemy's ability to acquire the BFV following an engagement.
- Do not construct berms. To be effective, a berm needs more than 20 feet of dirt, and this makes it easier for the attacker to spot the position. Dig one- and two-step fighting positions instead.
- Avoid positions that expose weapons to large numbers of enemy systems. It is best to hide weapons from major portions of the enemy formation. The weapon should be able to engage one or two of the enemy vehicles at the same time. It must be able to shift from its assigned sector of fire to engage other portions of the enemy formation (Figure 5-5, page 5-24).

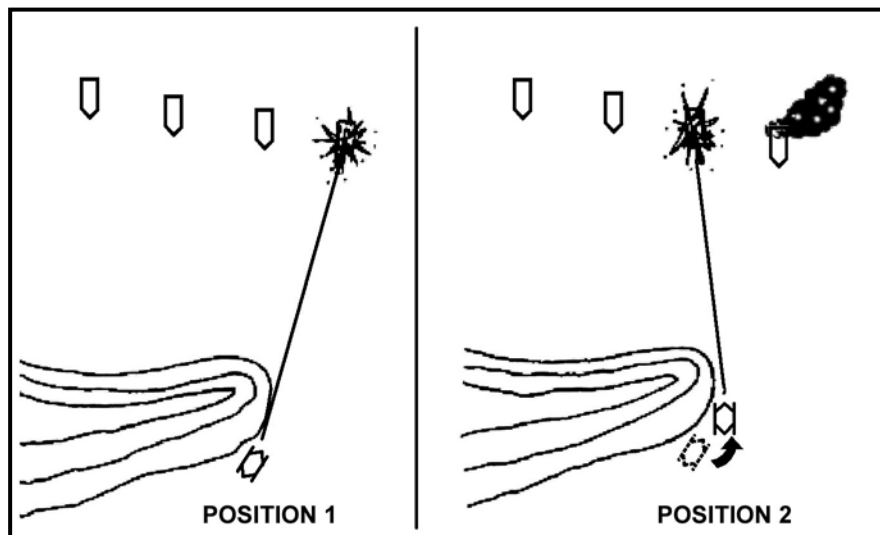

Figure 5-5. Hidden position with smaller fields of fire.

(4) Battlefield dust, smoke, fog, and darkness normally limit observation. When engagement ranges are reduced, flanking fires, use of obstacles, mutual support with the rifle squads, and covered and concealed positions increase in importance. Because of battlefield obscuration, weapons should be positioned to fight during limited visibility or be able to quickly move to alternate positions.

b. **Javelin Employment.** The Javelin's primary role is to destroy enemy armored vehicles. When there is no armored vehicle enemy, the Javelin can be employed in a secondary role of providing fire support against point targets such as bunkers and crew-served weapons positions. In addition, the Javelin's CLU can be used alone as an aided vision device for reconnaissance, security operations, and surveillance. Reduced or limited visibility will not degrade the effectiveness of the Javelin. This allows the antiarmor specialist to continue to cover his sector without having to reposition closer to the avenue of approach. The platoon leader's assessment of the factors of METT-TC will determine the employment of Javelins (For a detailed discussion on the employment of the Javelin refer to Appendix F). Based on the situation, the platoon leader may employ all or some of the Javelins. He has two options:

- *Centralized Control.* The platoon leader controls the fires of his Javelin gunners, either physically locating the weapons in his vicinity and personally directing their fires, or by grouping them together under the control of the platoon sergeant or another designated leader.
- *Decentralized Control.* Javelin gunners operate with, and are controlled by their squad leaders. The squad leader may need to employ one fire team with a Javelin. The platoon leader normally gives the command to fire.

c. **M240B and M249 Employment.** These are the platoon's primary dismounted weapons and are positioned first if the enemy is a dismounted force (For a detailed discussion on the employment of the M240B and the M249 refer to Appendix B). Once these guns are sited, the leader positions riflemen to protect them. The guns are

positioned to place direct fire on locations where the platoon leader wants to concentrate combat power to destroy the enemy.

d. **M203 Employment.** The M203 is the squad leader's indirect fire weapon. He positions it to cover dead space in the squad's sector, especially the dead space for the M240B and M249. The grenadier is also assigned a sector of fire overlapping the riflemen's sectors of fire. The high-explosive, dual-purpose (HEDP) round is effective against lightly armored vehicles such as the BMP-1 and the BTR (an eight-wheeled armored personnel carrier).

e. **Employment of Riflemen.** The platoon and squad leaders assign positions and sectors of fire to each rifleman in the platoon. Normally, they position the riflemen to support and protect the machine guns, squad automatic weapons, and antiarmor weapons. Riflemen also are positioned to cover obstacles, provide security, cover gaps between platoons and companies, or provide observation.

5-29. COORDINATION

Coordination is important in every operation. In the defense, coordination ensures that units provide mutual support and interlocking fires. In most circumstances, the platoon leader conducts face-to-face coordination to facilitate understanding and to resolve issues effectively, but when time is extremely limited, digital coordination may be the only means of sending and receiving this information. The platoon leader should send and receive the following information using his radio (or FBCB2, if equipped) prior to conducting face-to-face coordination:

- Location of leaders.
- Location of fighting positions.
- Location of OPs and withdrawal routes.
- Location and types of obstacles.
- Location, activities, and passage plan for scouts and other units forward of the platoon's position.
- Platoon's digital sector sketch.
- Location of all soldiers and or units operating in and around the platoon's area of operations.

NOTE: Current techniques for coordination hold true for units that are M2A3-equipped. If a digitized (M2A3) and a non-digitized unit are conducting adjacent unit coordination, face-to-face is the preferred method. The leader of the digitized unit has the option to enter pertinent information about the non-digitized unit into FBCB2 for later reference. The M2A3-equipped platoon leader should show the adjacent unit leader his digital sector sketch. If face-to-face coordination is not possible, leaders share pertinent information by radio.

Section VI. DEFENSIVE TECHNIQUES

The company team commander's analysis will determine the most effective manner in which to defend. He will direct to the platoons what defensive techniques to employ. The platoon normally will defend using one of these basic techniques.

- Defend in sector.
- Defend a battle position.
- Defend a strong point.
- Defend a perimeter.
- Defend a reverse slope.

5-30. DEFEND IN SECTOR

Defending in sector allows a unit to maintain flank contact and security and ensures unity of effort in the scheme of maneuver. Sectors afford depth in the platoon defense. They allow the platoon to achieve the platoon leader's desired end state while facilitating clearance of fires at the appropriate level of responsibility. The company team commander normally orders a platoon to defend in sector (Figure 5-6) when flexibility is desired, when retention of specific terrain features is not necessary, or when the unit cannot concentrate fires because of any of the following factors:

- Extended frontages.
- Intervening, or cross-compartmented, terrain features.
- Multiple avenues of approach.

The platoon is assigned a defend-in-sector mission to prevent enemy forces from penetrating the rear boundary of the sector. To maintain the integrity of the sector defense, the platoon must remain tied to adjacent units on the flanks. The company team commander may direct the platoon to conduct the defense in one of two ways:

- a. He may specify a series of subsequent defensive positions within the sector from which the platoon will defend to ensure that the fires of two platoons can be massed.
- b. He may assign a sector to the platoon. The platoon leader assumes responsibility for most tactical decisions and controlling maneuvers of his subordinate elements by assigning them a series of subsequent defensive positions. The company team commander will normally assign a sector to a platoon only when it is fighting in isolation

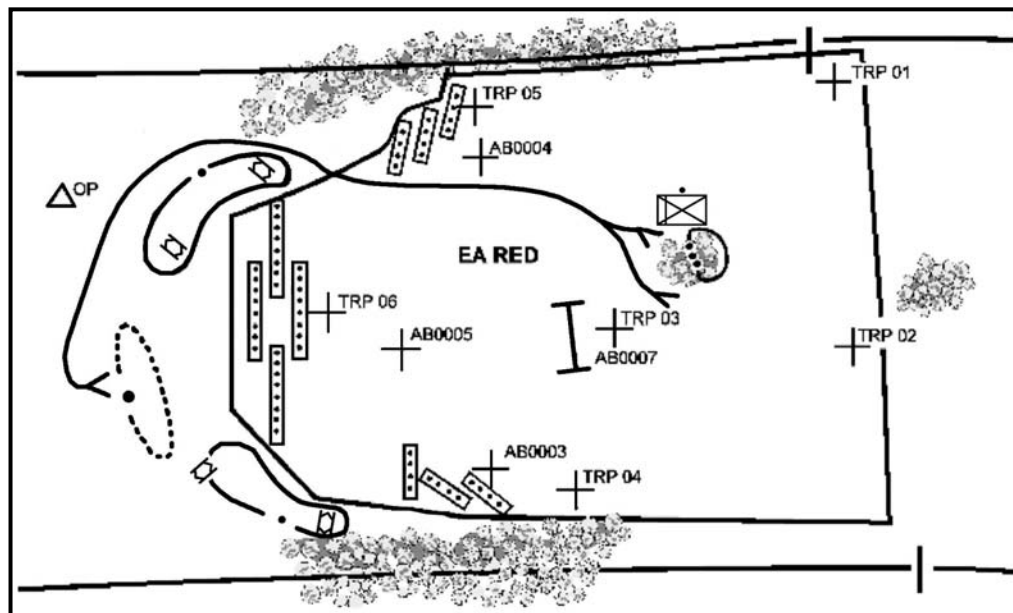

Figure 5-6. Concept of the operation for a defense in sector.

5-31. DEFEND A BATTLE POSITION

The company team commander assigns this defensive technique to his platoons when he wants to mass the fires of two or more platoons in a company team EA or to position a platoon to execute a counterattack. A unit defends from a BATTLE POSITION to:

- Destroy an enemy force in the EA.
- Block an enemy avenue of approach.
- Control key or decisive terrain.
- Fix the enemy force to allow another unit to maneuver.

The company team commander assigns platoon battle positions to allow each platoon to concentrate its fires or to place it in an advantageous position for the counterattack. The size of the platoon battle position can vary, but it should provide enough depth and maneuver space for subordinate elements to maneuver into alternate or supplementary positions and to counterattack. The battle position is a general position on the ground. The platoon leader places his BFVs on the most favorable terrain in the battle position based on the higher unit mission and commander's intent. The platoon then fights to retain the position unless ordered by the company team commander to counterattack or displace.

a. **Platoon Employment Considerations.** The following are basic methods of employing a platoon in a battle position:

- Same battle position, same avenue of approach.
- Same battle position, different avenues of approach.
- Different battle positions, same avenue of approach.
- Different battle positions, different avenues of approach.

(1) BFVs and rifle squads on the same battle position covering the same avenue of approach (Figure 5-7). The advantages of collocating the BFVs and rifle squads are:

- The platoon can defend against mounted and dismounted attacks and move rapidly to another position.

- Facilitates squads remounting of BFVs.
- Within the battle position, the BFV may be positioned with the squads forward or around the vehicles for security.
- The BFVs remain on the same battle position as the squads when the terrain provides good observation, fields of fire, and cover and concealment to both rifle squads and BFVs.
- The proximity of both the BFVs and rifle squads and their orientation on the same avenue of approach facilitates command and control.

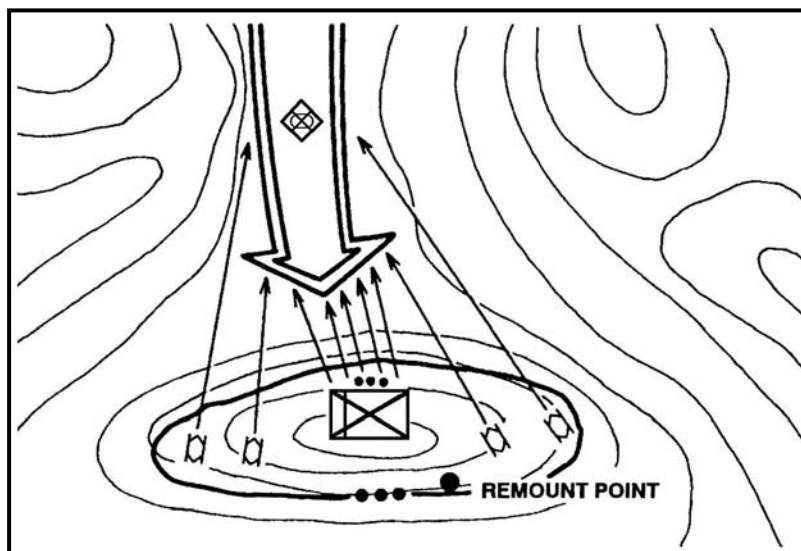

Figure 5-7. Same battle position, same avenue of approach.

(2) BFVs and rifle squads on the same battle position covering different avenues of approach (Figure 5-8).

- When the battle position has two equally dangerous avenues of approach, one with long-range and one with short-range fields of fire, the BFVs position to take advantage of their long-range fires while the rifle squads are placed for short-range fires.
- Each element is positioned on terrain best suited to its capabilities. During reduced visibility, the platoon leader may direct repositioning of some rifle squad elements to provide local security for the BFVs.
- This method requires that plans be made to shift BFVs if a dismounted avenue of approach becomes the most dangerous avenue of approach.

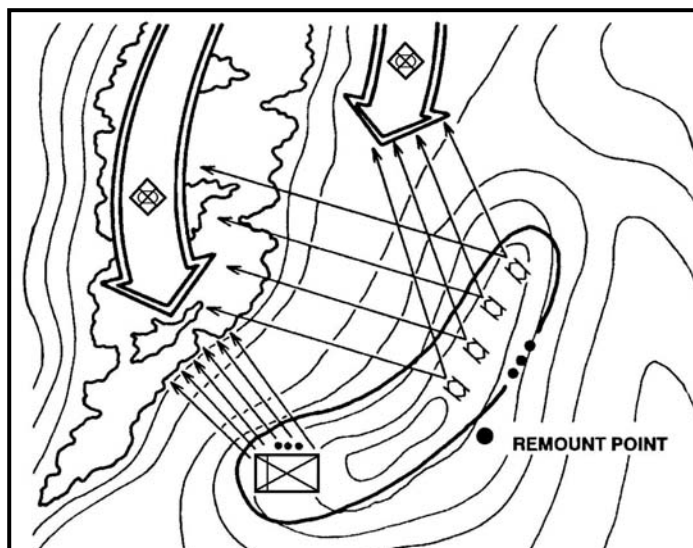

Figure 5-8. Same battle position, different avenues of approach.

(3) BFVs and rifle squads on different battle positions covering the same avenue of approach (Figure 5-9, page 5-30). If positioned on separate battle positions, BFVs and rifle squads must fight in relation to each other when covering the same avenues of approach. BFVs can provide supporting fires to the rifle squads from their primary, alternate, or supplementary positions. Both elements are positioned to engage enemy forces on the same avenue of approach, but at different ranges. There are basically three techniques to accomplish this:

- Place the rifle squads close enough to the EA to employ all their weapons. Place the BFVs in depth to enhance the antiarmor fires and to engage the enemy formation in depth. This technique enables the platoon to mass its fires on an enemy formation.
- Place the BFVs to engage the enemy in a specific EA and place the rifle squads in the most probable route the enemy infantry will use once the BFVs force the enemy to dismount their vehicles. This allows the platoon to take advantage of the BFVs' long-range firepower. The disadvantage is that rifle squads may not get into the fight and the platoon's firepower is not massed on the entire enemy formation.
- Place the rifle squads at choke points. Place the BFVs to support the infantry by destroying enemy armored vehicles as they seek to bypass the chokepoints by engaging in a supplemental EA or by firing into the same EA as the rifle squads. The BFVs can be employed forward of the rifle squads on the same avenue of approach. Then move to supplemental positions. This technique is especially useful in restrictive/severely restrictive terrain. (Figure 5-10, page 5-30.)

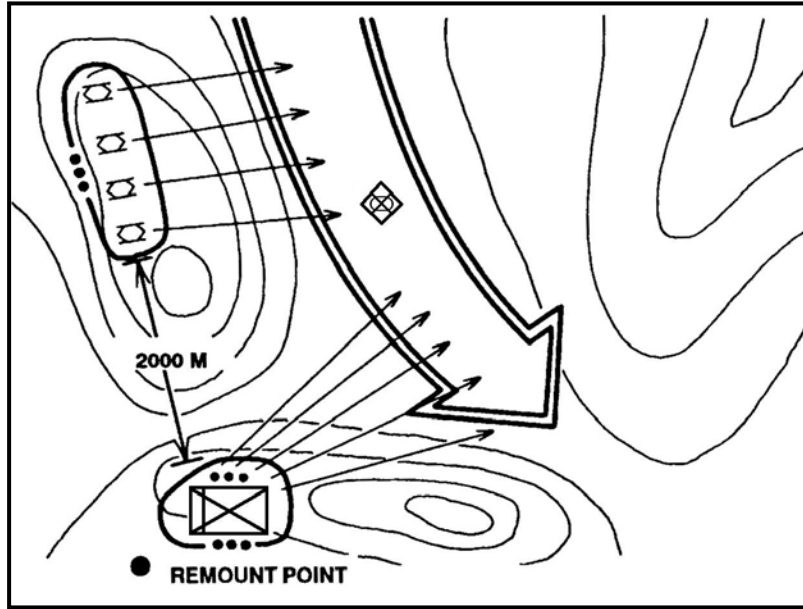

Figure 5-9. Different battle positions, same avenue of approach.

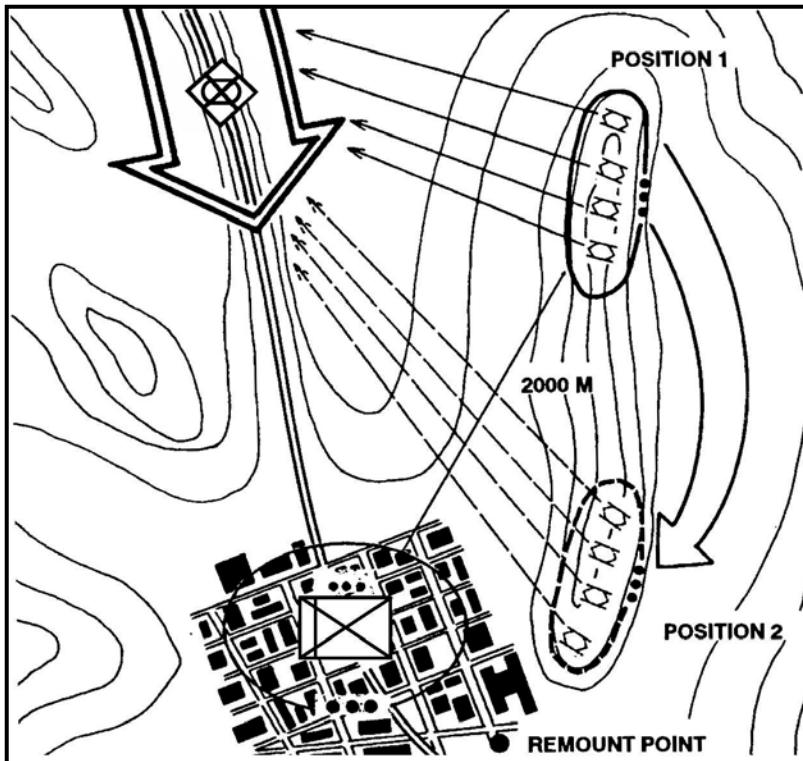

Figure 5-10. Bradleys displacing to support rifle squads.

(4) BFVs and rifle squads may be employed on different battle positions, different avenues of approach. If the platoon's BFVs and rifle squads are fighting in relationship to each other, then the platoon leader will likely locate with the rifle squads and the platoon sergeant will locate with the mounted element. When a platoon's BFVs and rifle squads will not be fighting in relation to each other, the control of both elements will likely be consolidated at company team level using the company team XO. The commander may consolidate all rifle squads in one location and deploy only the platoon's BFVs with the platoon leaders if—

- A large number of dismounted soldiers are required to hold a position, for example, key terrain.
- Primary positions for the rifle squads do not allow adequate fields of fire for BFV weapons.
- The rifle squads must occupy heavily wooded or rugged (severely restricted) terrain the BFVs cannot traverse.
- Both a mounted and dismounted avenue of approach must be defended and the terrain cannot be defended from the same battle position.

b. **Rifle Squad Considerations.** Rifle squads use available time to prepare fighting positions and obstacles. When the enemy attacks, BFVs normally engage enemy formations and, at a prearranged signal or event, move to alternate positions to the flank or to the rear of the rifle squads. The timing of this move is critical. While maximum advantage can often be gained by employing the mounted element forward, the BFVs become more vulnerable to enemy fire as the enemy closes. Rifle squads must be able to conduct operations without the support of the BFVs. The quantity and type of weapons, ammunition, mines, equipment, and supplies for the rifle squads must be considered.

c. **Mounted Element Considerations.** BFVs may be employed well forward to perform a specific task such as a screen or guard. A section with a squad can also conduct security operations. Normally, this is done under the direction and control of the company team commander.

5-32. DEFEND A STRONG POINT

Defending a strong point is not a common mission for a mechanized infantry force. Strong points sacrifice the mobility of the BFVs, require extensive engineer support (in terms of expertise, materials, and equipment), and take a long time to complete. When the platoon is directed to defend a strong point, it must retain the position until ordered to withdraw. The success of the strong-point defense depends on how well the position is tied into the existing terrain. This defense is most effective when it is employed in terrain that provides cover and concealment to both the strong point and its supporting obstacles. Mountainous, forested, or urban terrain can be adapted easily to a strong-point defense. Strong points placed in more open terrain require the use of reverse slopes or of extensive camouflage and deception efforts. This defensive mission may require the platoon to—

- Hold key or decisive terrain critical to the company team or task force scheme of maneuver.
- Provide a pivot to maneuver friendly forces.
- Block an avenue of approach.
- Canalize the enemy into one or more engagement areas.

a. The prime characteristic of an effective strong point is that it cannot be easily overrun or bypassed. It must be positioned and constructed so that the enemy knows he can reduce it only at the risk of heavy casualties and significant loss of materiel. He must be forced to employ massive artillery concentrations and dismounted infantry assaults in his attack, so the strong point must be tied in with existing obstacles and positioned to afford 360-degree security in observation and fighting positions.

NOTE: At company team level a mechanized infantry team normally executes a strong-point defense in order to take advantage of the numerous infantry squads and their ability to retain ground. The defensive can be used in conjunction with other techniques to make best use of the team's tanks and BFVs.

b. A variety of techniques and considerations are involved in establishing and executing the strong point defense including considerations for displacement and withdrawal from the strong point.

(1) The platoon leader begins by determining the projected size of the strong point, and by assessing the number of vehicles, weapon systems, and individual soldiers available to conduct the assigned mission as well as the terrain on which the platoon will fight. He must remember that although a strong point is usually tied into a company team defense and flanked by other defensive positions, it must afford 360-degree observation and firing capability.

(2) The platoon leader must ensure that the layout and organization of the strong point maximizes the capabilities of the platoon's personnel strength and weapon systems without sacrificing the security of the position. Siting options range from positioning all the vehicles outside the strong point (with the rifle squads occupying fighting positions inside it) to placing all assets within the position. From the standpoint of planning and terrain management, placing everything in the strong point is the most difficult option and potentially the most dangerous because of the danger of enemy encirclement (Figure 5-11).

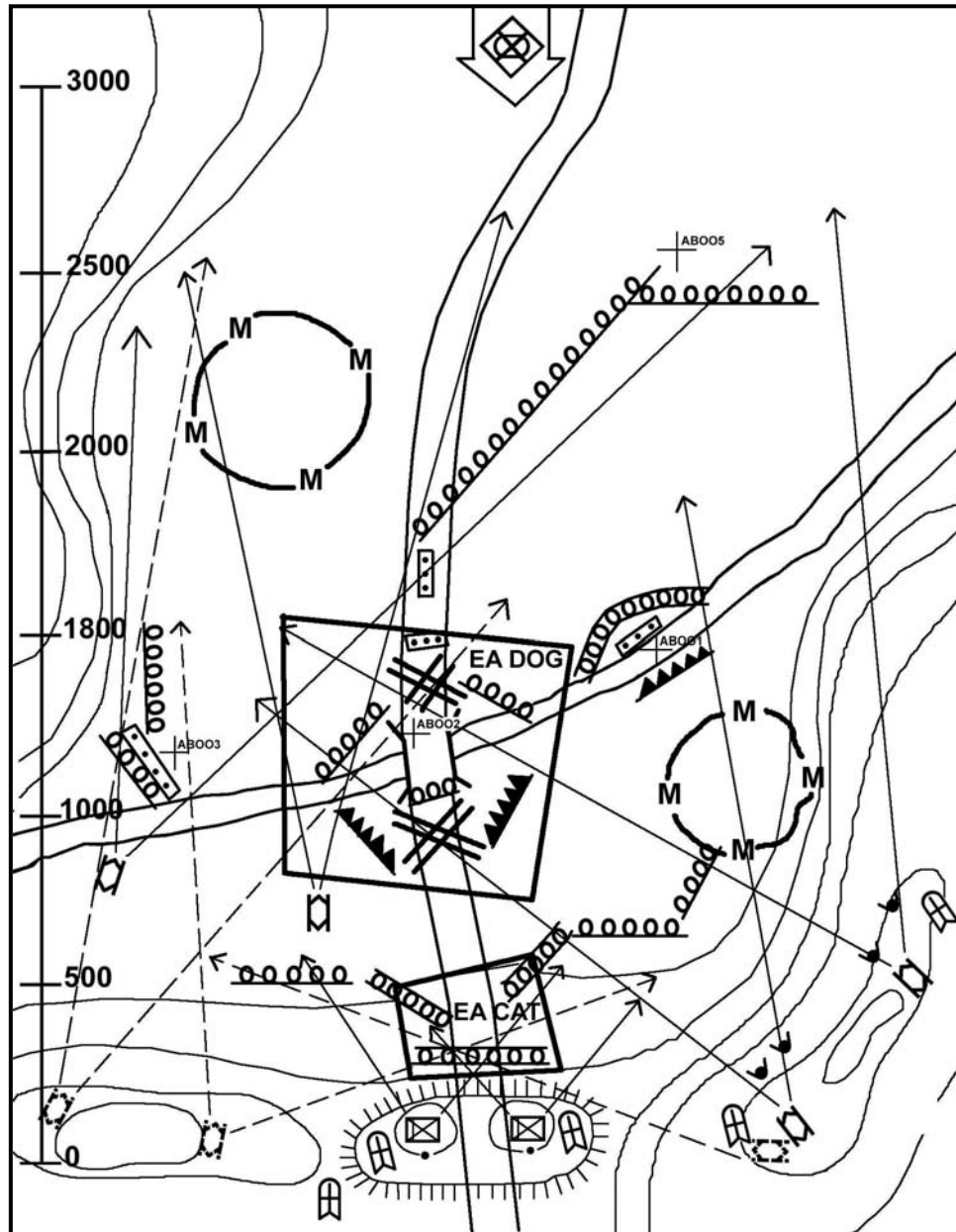

**Figure 5-11. Defending a strong point
(BFVs outside a strong point, rifle squad in reserve slope).**

(3) In laying out the strong point, the platoon leader designates weapon positions that support the company team defensive plan. Once these primary positions have been identified, he continues around the strong point, siting weapons on other possible enemy avenues of approach and EAs until he has the ability to orient effectively in any direction. The fighting positions facing the company team EA may be along one line of defense or staggered in depth along multiple lines of defense (if the terrain supports positions in depth). Vehicle positions may be located abreast of the two-man fighting positions or, for greater depth, behind them. The platoon leader can create a broader strong point frontage by interspersing vehicle and rifle squad positions.

(4) The platoon's reserve may be comprised of mounted sections, fire teams, or a combination of the two. The platoon leader must know how to influence the strong point battle by employing his reserve. He has several employment options including reinforcing a portion of the defensive line or counterattacking along a portion of the perimeter against an identified enemy main effort.

(5) The platoon leader should identify routes or axes that will allow the reserve to move to any area of the strong point. He should then designate positions the reserve can occupy once they arrive. These routes and positions should afford sufficient cover to allow the reserve to reach its destination without enemy interdiction. The platoon leader should give special consideration to developing a direct fire plan for each contingency involving the reserve. The key area of focus may be a plan for isolating an enemy penetration of the perimeter. Rehearsals cover actions the platoon takes if it has to fall back to a second defensive perimeter and include the direct fire control measures necessary to accomplish the maneuver. FPF may be employed to assist in the displacement.

c. Engineers support strong point defense by reinforcing the existing obstacles. Priorities of work will vary depending on the factors of METT-TC, especially the enemy situation and time available. For example, the first 12 hours of the strong point construction effort may be critical for emplacing countermobility and survivability positions as well as command and control bunkers. On the other hand, if the focus of engineer support is to make the terrain approaching the strong point impassable, the task force engineer effort must be adjusted accordingly.

(1) The task force obstacle plan provides the foundation for the company team strong point obstacle plan. The commander or platoon leader determines how he can integrate protective obstacles (designed to defeat dismounted infantry assaults) into the overall countermobility plan. If adequate time and resources are available, he should plan to reinforce existing obstacles using field expedient demolitions.

(2) Once the enemy has identified the strong point, he will mass all the fires he can spare against the position. To safeguard his rifle squads, the platoon leader must arrange for construction of overhead cover for individual fighting positions. If the strong point is in a more open position, such as on a reverse slope, he may also plan for interconnecting trench lines that will allow soldiers to move between positions without exposure to direct and indirect fires. Time permitting, these crawl trenches can be improved to fighting trenches or standard trenches.

5-33. DEFEND A PERIMETER

A perimeter defense allows the defending force to orient in all directions. In terms of weapons emplacement, direct and indirect fire integration, and reserve employment, a platoon leader conducting a perimeter defense should consider the same factors as a strong point operation.

a. The perimeter defense is a relatively uncommon mission for a mechanized platoon because it allows only limited maneuver and limited depth. Nonetheless, the platoon may be called on to execute a perimeter defense under a variety of conditions to include—

- Holding critical terrain in areas where the defense is not tied in with adjacent units.

- Defending in place when it has been bypassed and isolated by the enemy.
- Conducting occupation of an independent assembly area or reserve position.
- Preparing a strong point.
- Concentrating fires in two or more adjacent avenues of approach.
- Defending CS or CSS assets.
- Occupying a patrol base when dismounted.

NOTE: The perimeter defense is normally conducted at task force or higher level to protect maneuver units against Level III enemy and to protect CS and CSS assets against Level I and II enemy.

b. The major advantage of the perimeter defense (Figure 5-12) is the platoon's ability to defend against an enemy avenue of approach. A perimeter defense differs from other defenses in that—

- The trace of the platoon is circular or triangular rather than linear.
- Unoccupied areas between squads and vehicles are smaller.
- Flanks of squads and sections are bent back to conform to the plan.
- The bulk of combat power is on the perimeter.
- The reserve is centrally located.

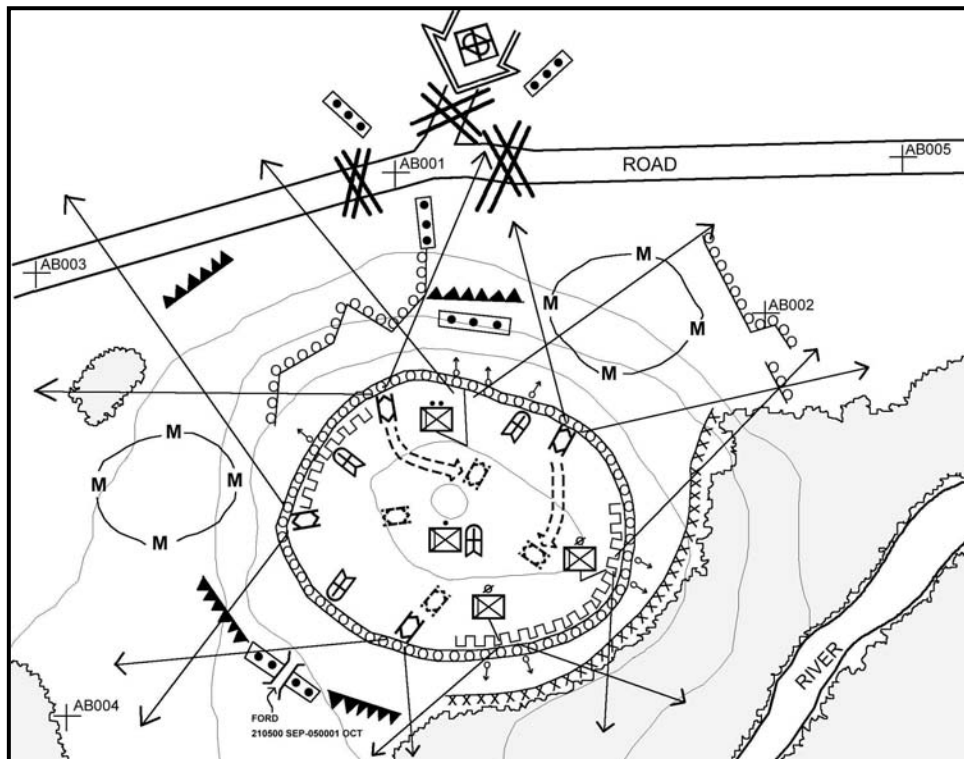

Figure 5-12. Perimeter defense with rifle squad in reserve.

NOTE: A variant of the perimeter defense is the use of the shaped defense, which allows two of the team's platoons to orient at any particular time on any of three engagement areas.

5-34. DEFEND ON A REVERSE SLOPE

The platoon leader's analysis of the factors of METT-TC often leads him to employ his forces, especially rifle squads, on the reverse slope (Figure 5-13). If the rifle squads are on a mounted avenue of approach, they must be concealed from enemy direct-fire systems. This means rifle squads should be protected from enemy tanks and observed artillery fire. This applies even when rifle squads are fighting with their BFVs.

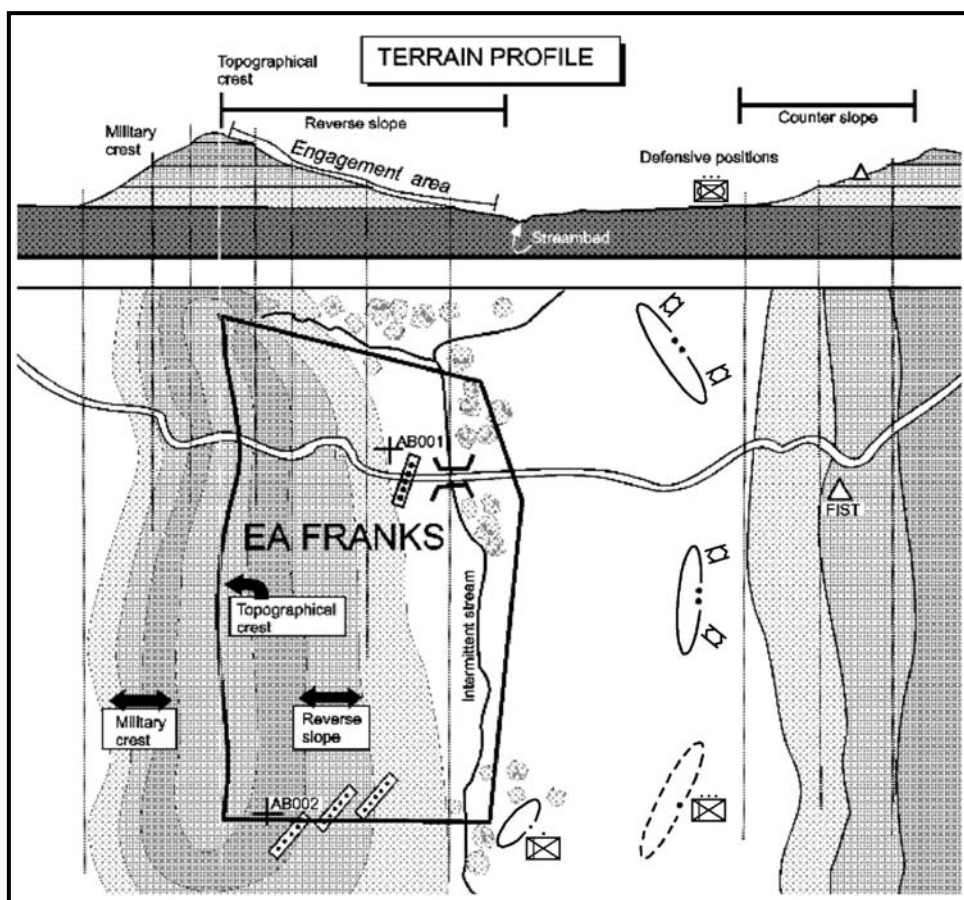

Figure 5-13. Reverse-slope defense options.

a. The majority of a rifle squad's weapons are not effective beyond 600 meters. To reduce or preclude destruction from enemy direct and indirect fires beyond that range, a reverse-slope defense should be considered. This conflicts to some extent with the need for maximum observation forward to adjust fire on the enemy and the need for long-range fields of fire for friendly BFVs and tanks. In some cases it may be necessary for these vehicles to be deployed forward while the rifle squads remains on the reverse slope. The vehicles withdraw from their forward positions as the battle closes. Their new

positions should be selected to take advantage of the BFV's long-range fires to get enfilade shots from the depth and the flanks of the reverse slope.

b. The nature of the enemy may change at night, and the rifle squads may occupy the forward slope or crest to deny it to the enemy. In those circumstances, it is feasible for a rifle squad to have an alternate night position forward. The area forward of the topographical crest must be controlled by friendly forces through aggressive patrolling and both active and passive reconnaissance measures. The platoon should use all of its night vision devices to deny the enemy undetected entry into the platoon's defensive area. The BFV is a key part of the platoon's surveillance plan and should be positioned to take advantage of its thermal sights (ISU or IBAS). The enemy must not be allowed to take advantage of reduced visibility to advance to a position of advantage without being taken under fire.

c. The company team commander normally makes the decision to position platoons on a reverse slope. He positions platoons on a reverse slope when—

- He wishes to surprise or deceive the enemy about the location of his defensive position.
- A forward slope might be made untenable by direct enemy fire.
- Occupation of the forward slope is not essential to achieve depth and mutual support.
- Fields of fire on the reverse slope are better or at least sufficient to accomplish the mission.
- Forward slope positions are likely to be the target of concentrated enemy artillery fires.

d. The following are advantages of a reverse-slope defense:

- Enemy observation of the position, including the use of surveillance devices and radar, is masked.
- Enemy cannot engage the position with direct fire without coming within range of the defender's weapons.
- Enemy indirect fire will be less effective because of the lack of observation.
- Enemy may be deceived about the strength and location of positions.
- Defenders have more freedom of movement out of sight of the enemy.

e. Disadvantages of a reverse-slope defense include the following:

- Observation to the front is limited.
- Fields of fire to the front are reduced.
- Enemy can begin his attack from a closer range.

f. BFVs offer the platoon additional opportunities with regard to positioning. They can begin positioned forward to take advantage of their protection from artillery and their ability to engage the enemy at long ranges. After an initial engagement, BFVs may move over or around the crest line and through the rifle squads on the reverse slope to a position either on the flanks or farther in depth to the rear.

g. Obstacles are necessary in a reverse-slope defense. Since the enemy will be engaged at close range, obstacles should prevent the enemy from closing too quickly and overrunning the positions, and they should facilitate the platoon's disengagement.

Section VII. RETROGRADE OPERATIONS

The retrograde is a type of defensive operation that involves organized movement away from the enemy. The enemy may force these operations, or a commander may decide to execute them voluntarily. The platoon will execute retrograde operations as a part of a larger force. The three forms of retrograde operations are withdrawal, delay, and retirement.

5-35. WITHDRAWAL

A withdrawal is a planned operation that occurs when an element disengages from enemy contact to reposition itself for another mission. A platoon usually conducts a withdrawal as part of a larger force. As part of a company, a platoon may fall back with the main element (under pressure) or may be used as the detachment left in contact (DLIC) in a withdrawal not under pressure. The following information applies whether or not the platoon is under pressure from the enemy. Regardless of employment, the platoon leader conducts his withdrawal IAW his higher commander's guidance. On receipt of the order to conduct a withdrawal, the platoon leader begins preparing his order based on his higher unit's FRAGO. He identifies possible key terrain and routes based on the higher unit's graphics and his map. He formulates and briefs his FRAGO to his squad leaders and BCs. When the withdrawal is executed, squad leaders and BCs ensure they are moving IAW the platoon leader's plan. If the operation occurs during limited visibility, infrared and thermal equipment enhances command and control and navigation during movement as explained in linkup operations.

a. **Withdrawal Not Under Pressure.** In this type of withdrawal, platoons normally serve as the DLIC or as part of the DLIC (Figure 5-14). A DLIC is used to deceive the enemy into thinking that the entire force is still in position. As the DLIC, the platoon—

- Repositions BFV sections, squads, and weapons to cover the company's withdrawal (Figure 5-15).
- Repositions a squad and a BFV in each of the other platoon positions to cover the most dangerous avenue of approach into the position.
- Continues the normal operating patterns of the company and simulates company radio traffic.
- Covers the company withdrawal with planned direct BFV fire, dismounted infantry fire, and indirect fire if the company is attacked during withdrawal.
- Withdraws by echelon once the company is at its next position. The BFV is specially suited for this purpose because of its protection, mobility, and organic weapons systems.

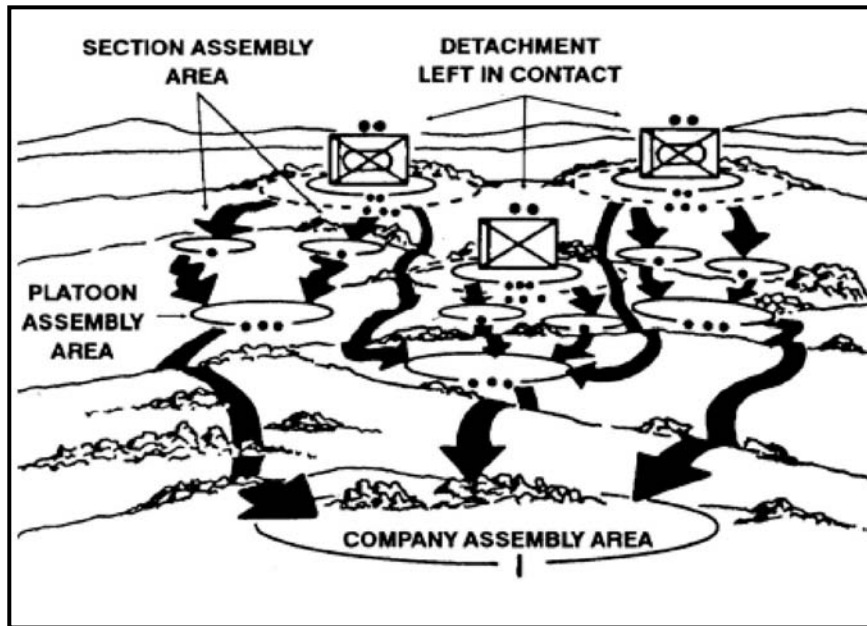

Figure 5-14. Withdrawal not under pressure.

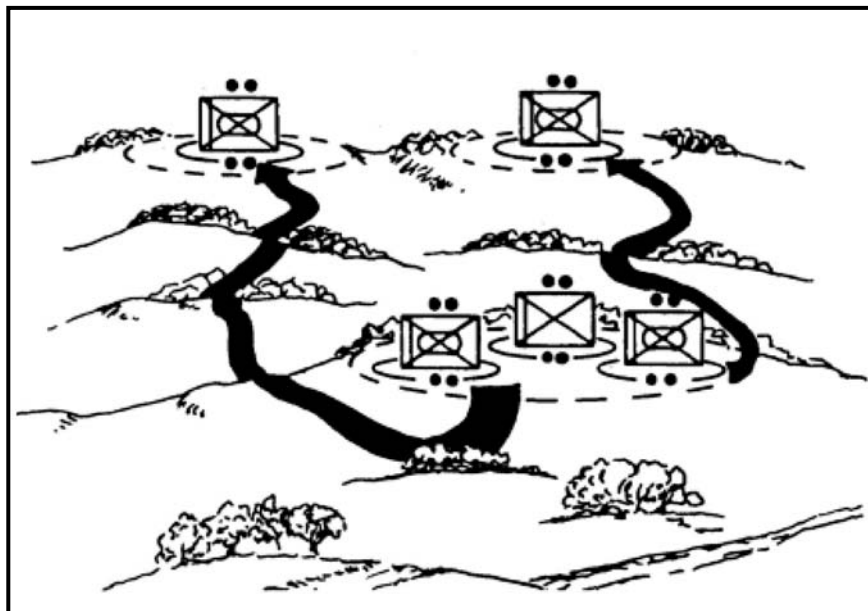

Figure 5-15. Repositioning of squads and section.

b. **Withdrawal Under Pressure.** If the platoon cannot prepare and position the security force, it conducts a fighting withdrawal. The platoon disengages from the enemy by maneuvering to the rear (Figure 5-16, page 5-40). Soldiers, squads, or BFV sections not in contact are withdrawn first to provide suppressive fires and allow the soldier, squad, or BFV sections in contact to withdraw.

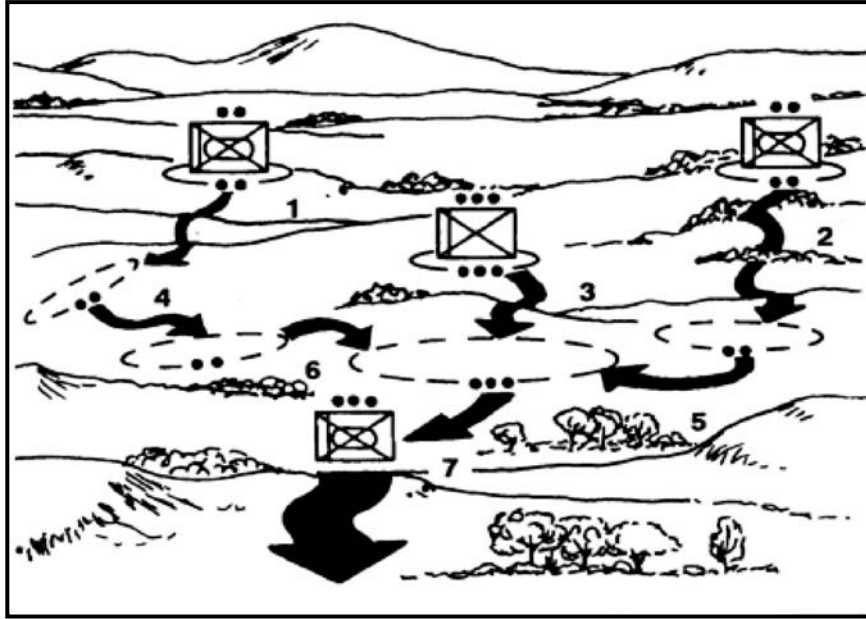

Figure 5-16. Bounding overwatch to the rear.

c. **Disengagement.** Based on orders from the task force commander, the commander decides how long to retain defensive positions. The company or company team may be required to remain and fight as long as possible, or it may be required to disengage and displace to subsequent positions. As part of a company or company team, a platoon may disengage to defend from another battle position, to prepare for a counterattack, to delay, to withdraw, or to prepare for another mission.

(1) Fire and movement to the rear is the basic tactic for disengaging. All available fires are used to slow the enemy and allow platoons to move away. The commander may move his platoons and mass fires to stop or slow the enemy advance before beginning the movement away from the enemy.

(a) A base of fire is formed to cover platoons, sections or squads moving away from the enemy. One platoon, section or squad acts as the base of fire, delaying the enemy with fire or retaining terrain blocking his advance, while other units break contact (Figure 5-17).

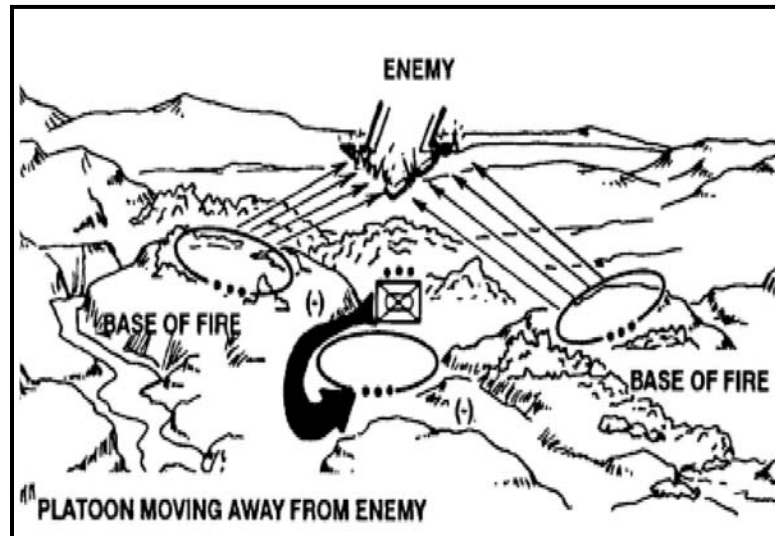

Figure 5-17. Breaking contact.

(b) Moving platoons, sections or squads arrive at their next position and provide a base of fire to cover the rearward movement of forward units (Figure 5-18).

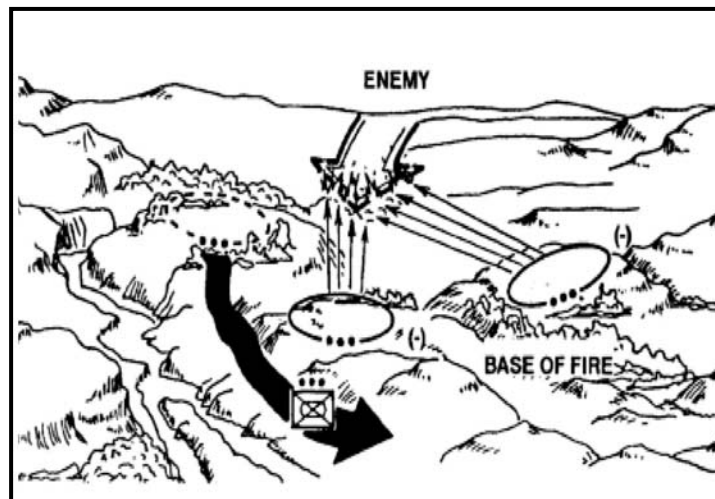

Figure 5-18. Rearward movement.

(c) Fire and movement is repeated until contact with the enemy is broken, the platoon passes through a higher unit base-of-fire force, or the platoon is in position to resume its defense.

(d) Tactics used by the platoon to disengage from the enemy differ according to how the platoon is deployed, the commander's plan for disengagement, and other factors of METT-TC. The following actions apply in all cases.

- Maximum use is made of the BFV's firepower to cover rearward movement.
- BFVs back out of position to cover or concealment, and move, keeping one terrain feature between the vehicle and the enemy.
- Turret weapons remain pointed in the direction of the enemy.

- Rapid movement and an effective base of fire enhance the mobility advantage and are key to successful disengagements.

(2) Plans for disengagement may be part of any defensive plan. When squads are deployed, a plan for rapid remounting must be made.

(a) When the platoon employs the BFV and rifle squads on separate positions, platoon remount points and routes to the remount points must be chosen. In addition, routes must be rehearsed and timed. The platoon remount point can be near the rifle squad's position, near the BFV position, or between the two (Figure 5-19).

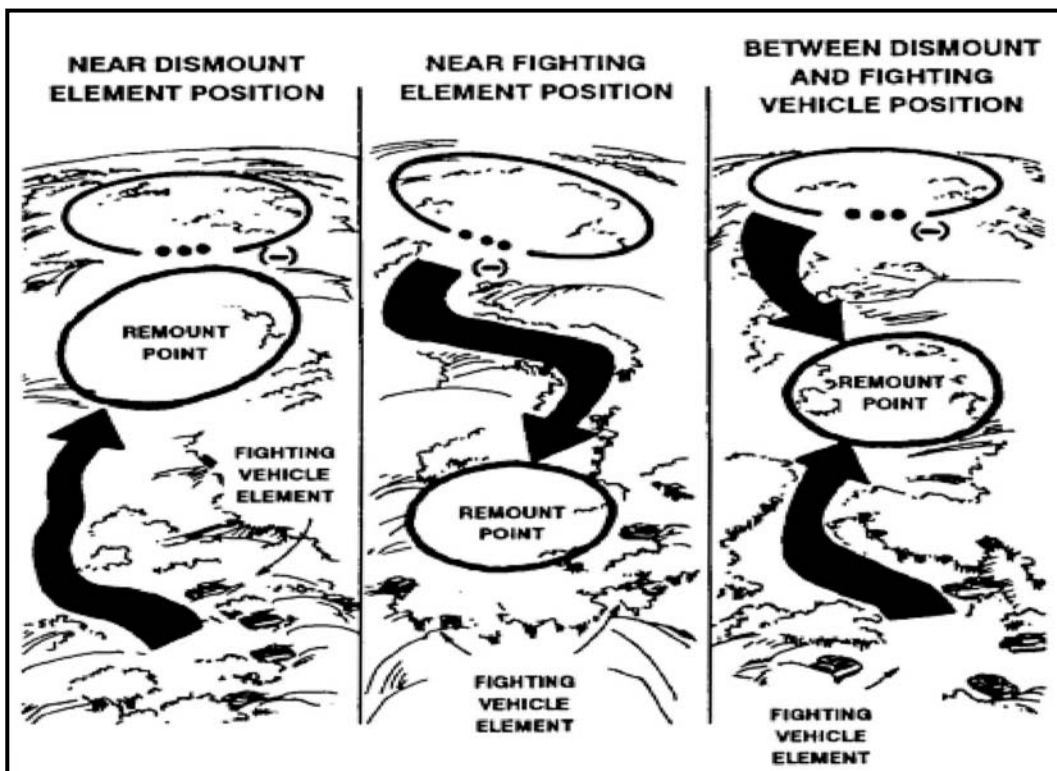

Figure 5-19. Platoon remount points.

(b) Covered positions for vehicles and rifle squads should be chosen to allow for easy remounting even during limited visibility in the remount point. Squad leaders must ensure their men know where the remount point is, where the vehicle is, and routes to the point. Routes to the remount point should be covered and should allow speedy movement for both elements. Planning considerations include the following:

- BFVs move faster (mobility), have better firepower, and have more protection from small-arms fire and artillery fragments than dismounted soldiers.
- BFVs often shift from one firing position to another, so routes must be planned from each position to the remount point.

(3) When the dismounted and fighting vehicle elements are separated, there are three ways the dismounted element can disengage. Simultaneous disengagement (moving all teams at the same time) can be used if the element is covered by another force. When the

dismounted element must cover its own movement, it disengages by fire teams or by thinning the lines.

(a) When the squads simultaneously disengage, they assemble and move as one element to the remount point using appropriate movement techniques. Simultaneous disengagement is favored when rapid movement is critical, when the disengaging element has adequate overwatching fires, when the enemy has not closed on the rifle squad or cannot fire effectively at it, or when there are obstacles to delay the enemy.

(b) When the rifle squads must cover their own movement, two squads stay in position as a base of fire. The third squad moves to the rear. The squads left in position must fire into the entire element's sector to cover the movement of the other squad. Sectors of fire are adjusted for better coverage. The moving squad may displace by fire teams (Figure 5-20). The squad left in position sequentially disengages. Two squads provide a base of fire while one squad disengages. Movement to the rear by alternating squads continues until contact is broken. Once contact is broken disengagement is complete, and the rifle squads move to the remount point using appropriate movement techniques.

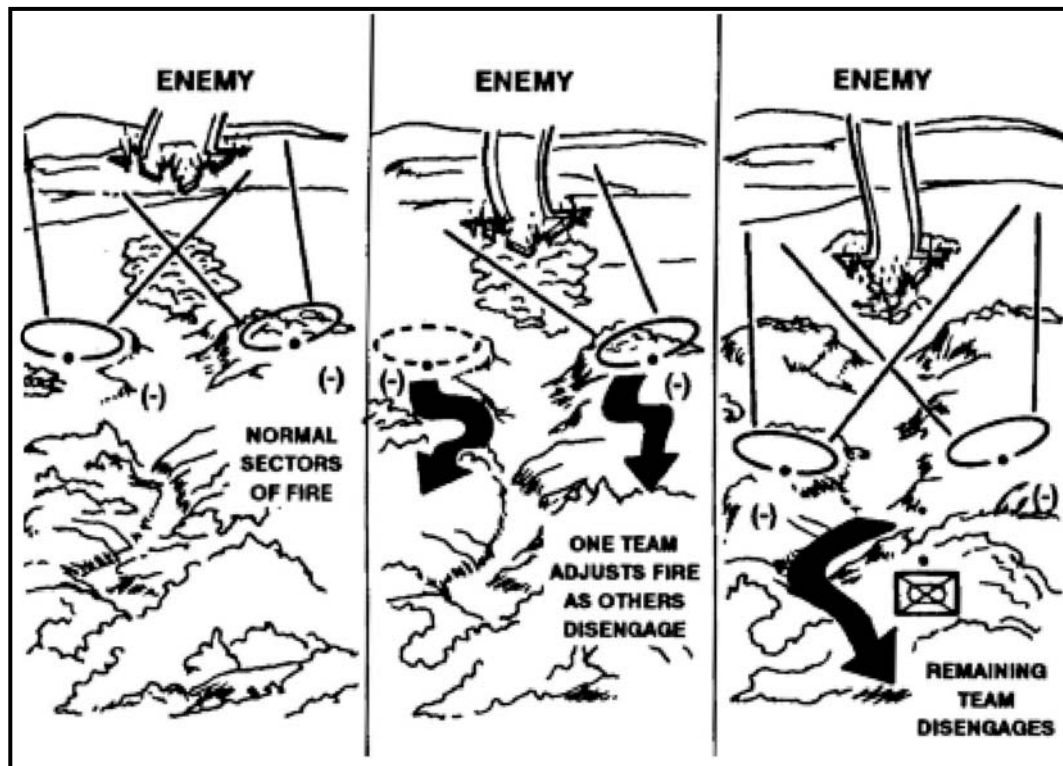

Figure 5-20. Disengagement by fire teams.

(c) When disengaging by thinning the lines, selected soldiers from each fire team (often one soldier from each fighting position) disengage and move to the rear. The soldiers still in position become the base of fire to cover the movement (Figure 5-21, page 5-44).

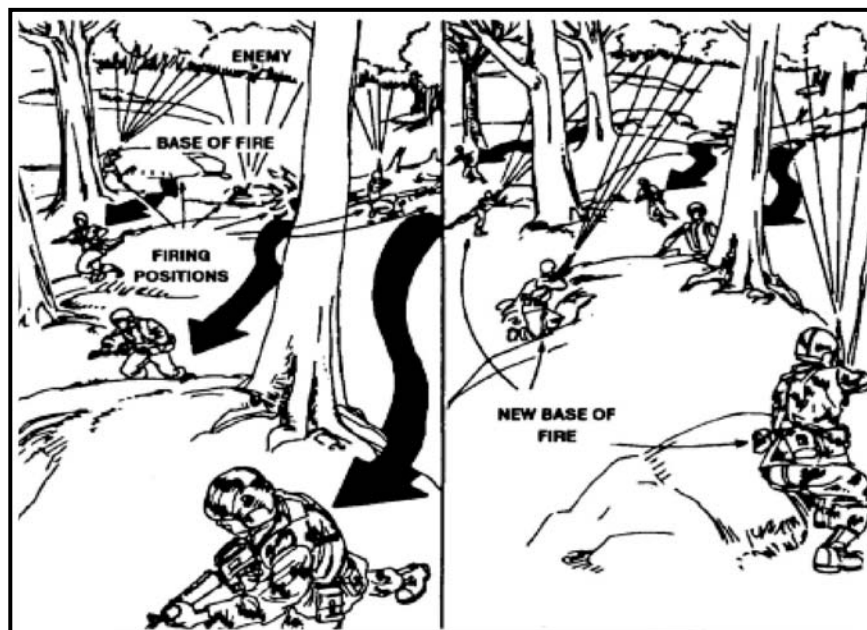

Figure 5-21. Disengagement by thinning the lines.

(d) When BFVs and rifle squads are employed on the same position, the squads normally move to the remount point while the BFVs provide a base of fire. The BFVs then quickly move to the remount point, link up with the rifle squads, load them, and move out. Squads use the disengagement techniques discussed previously. The method selected is dictated by the enemy situation, terrain, fighting vehicle crews' ability to serve as a base of fire, and type and amount of overwatching fires.

(4) ***Fighting Vehicle Element Disengagement.*** Because of the BFV's mobility, firepower, and protection against small-arms fire and artillery shell fragments, it is usually best for the dismounted element (when deployed) to disengage while covered by the BFVs. If the BFVs are not in a position to support the dismount element by fire, or if the dismount element is heavily engaged, the fighting vehicle element may disengage first and move to a position to assist the dismounted element in disengagement. Whichever method is used, there are two basic ways the vehicle element can disengage. If BFVs are covered by another force, simultaneous disengagement may be used. If BFVs must cover their own movement, they disengage by section. These methods are similar to those used by the dismount element.

(a) ***Simultaneous Disengagement.*** When BFVs disengage simultaneously, they move as a platoon as quickly as possible. This method normally is used when BFVs are covered by another force and speed is the most critical factor. If fire teams are already mounted, the entire platoon moves, using movement techniques, to a position designated by the commander. If fire teams are deployed, BFVs move to the remount point to pick them up, or they may attack the enemy by fire from a new position to allow the fire teams to disengage (Figure 5-22).

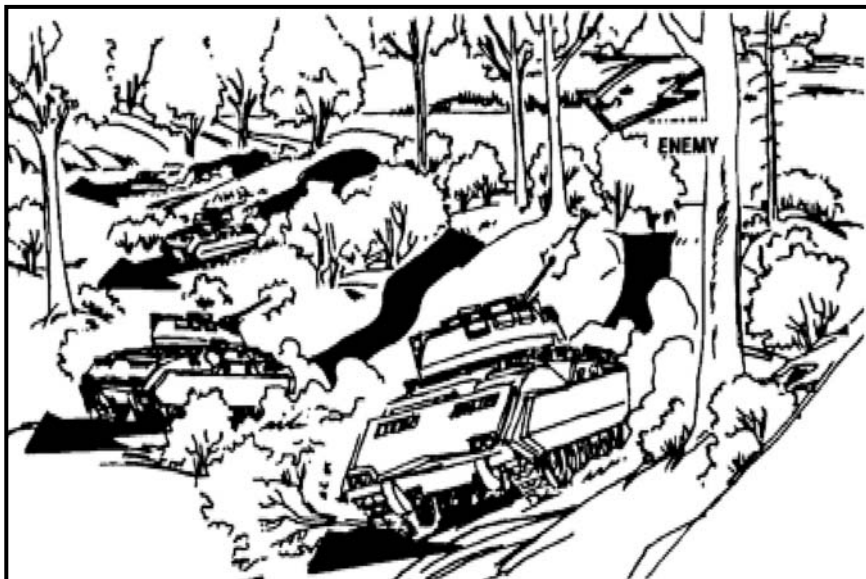

Figure 5-22. Simultaneous disengagement.

(b) *Disengagement by Vehicle or Section.* When BFVs in the platoon must cover their own disengagement, one, two, or three vehicles can be left in position as a base of fire while the remaining elements move to the rear. BFVs left in position must cover the entire sector until the moving vehicles reach positions that they can use to provide a base of fire (Figure 5-23).

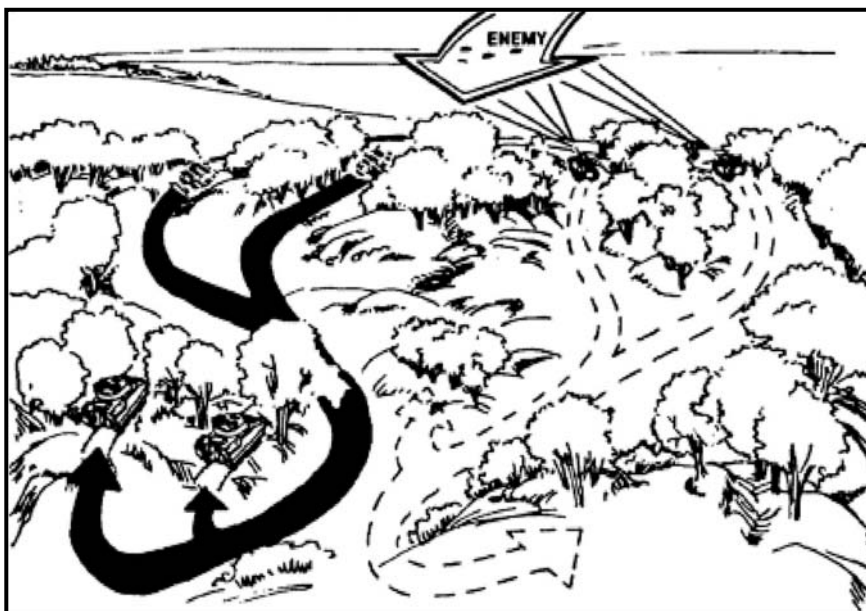

Figure 5-23. Disengagement by sections.

5-36. DELAY

A delay is a form of retrograde in which a force under pressure trades space for time by slowing the enemy's momentum and inflicting maximum damage on the enemy without becoming decisively engaged. The commander will direct the method of delay to the platoons. In either method of a delay, the rifle platoon forces the enemy to slow its movement by forcing him to repeatedly deploy for the attack. Before the enemy assault, the delaying force withdraws to new positions. The squads or sections and platoons disengage from the enemy as described in a withdrawal under pressure (see paragraph 5-35). Once disengaged, a platoon moves directly to its next position and defends again. The squads and platoons slow the advance of the enemy by shaking his morale, causing casualties and equipment losses. To accomplish a delay, the platoon can employ—

- Ambushes.
- Snipers.
- Obstacles.
- Minefields (to include phony minefields).
- Artillery and mortar fire.

a. **Delay from Alternate Positions.** This method of delay is employed when the area of operations is narrow and the commander has adequate forces to split between different positions. For example, as the first and second platoons engage the enemy, third platoon occupies the next position in depth and prepares to assume responsibility for the fight. First and second platoon disengage from the enemy, pass through/around the third platoon, and move to the next position. The advantage of this method is that it allows positioning in depth, allows for more time equipment and soldier maintenance, and increases flexibility. The disadvantages are that it requires continuous coordination, requires a passage of lines, and engages only a portion of the enemy at one time.

b. **Delay from Subsequent Positions.** This method of delay is employed when the area of operations is wide and the forces available to the commander do not allow themselves to be split. All delaying subordinate units are committed to each of the series of battle positions along the same phase line. The commander will stagger the movement of delaying elements so that not all of them are moving at the same time. The advantage of this method is that the commander is able to mass the effects of all available combat power. The disadvantages are that there is limited depth to the delay positions, less available time to prepare subsequent positions, and less flexibility.

5-37. RETIREMENT

A retirement is a form of retrograde in which a force out of physical contact with the enemy moves away from the enemy. Units conduct retirements as tactical road marches where security and speed are the most important considerations. The retiring unit generally moves to an assembly area in preparation for a future mission. The rifle platoon will participate in a retirement as part of a larger force.

Section VIII. FIGHTING AND SURVIVABILITY POSITIONS

The defensive plan will normally require building fighting positions. Fighting positions protect soldiers by providing cover from direct and indirect fires, and by providing concealment through positioning and proper camouflage.

5-38. PRINCIPLES

Following three basic principles will allow leaders to effectively and efficiently prepare fighting position. These principles are:

- Site positions to best engage the enemy.
- Prepare positions by stages.
- Leaders inspect all positions.

a. **Site Positions to Best Engage the Enemy.** The most important aspect of a fighting position is that it must be tactically well-positioned. Leaders must be able to look at the terrain and quickly identify the best location for fighting positions.

- Soldiers must be able to engage the intended enemy element within their assigned sectors of fire.
- Soldiers should be able to fire out to the maximum effective range of their weapons with maximum grazing fire and minimal dead space.
- Grenadiers should be placed in positions to cover dead space.
- Leaders must ensure fighting positions provide mutually supporting, interlocking fires. This allows them to cover the platoon's sector from multiple positions.
- When possible, site positions behind natural cover, and in easily camouflaged locations. The enemy must not be able to identify the position until it is too late and he has been effectively engaged.

b. **Prepare Positions by Stages.** Leaders must ensure their soldiers understand when and how to prepare fighting positions based on the situation. Soldiers prepare hasty fighting positions every time the platoon makes an extended halt. Half of the platoon digs in while the other half maintains security. Soldiers prepare positions in stages and a leader inspects the position at each stage before soldiers move to the next stage. (See the following example.)

STAGE 1: The platoon leader checks fields of fire from the prone position. For a stage 1 position (Figure 5-24, page 5-48), the soldiers—

- Emplace sector stakes.
- Stake the primary sector.
- Position grazing fire log or sandbag between the sector stakes.
- Place the aiming stake(s), if required, to allow limited visibility engagement of a specific target.
- Scoop out elbow holes.
- Trace the outline of the position on the ground.
- Clear the fields of fire for both the primary and secondary sectors of fire.
- The leader inspects the position.

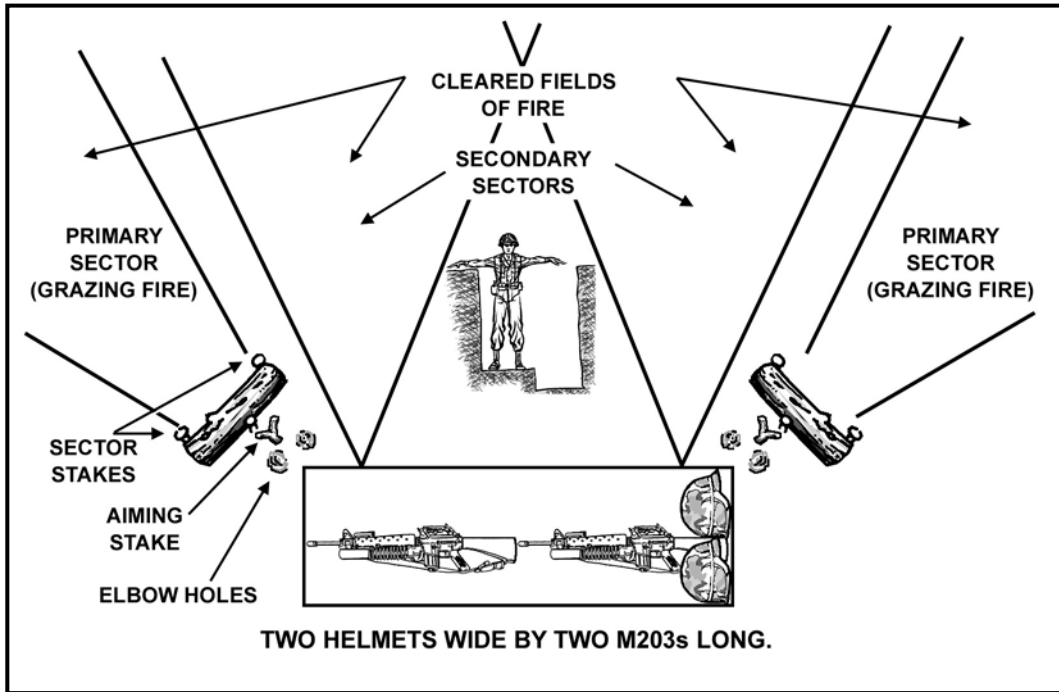

Figure 5-24. Stage 1, Preparations of a fighting position.

STAGE 2: Soldiers prepare retaining walls (Figure 5-25) for the parapets. They ensure that—

- There is a minimum distance (equal to the width of one helmet) from the edge of the hole to the beginning of the front, flank, and rear cover.
- The cover to the front consists of sandbags (or logs), two to three high. For a two-soldier position, it is about two M203 lengths long.
- The cover to the flanks is the same height, but only one M203 rifle long.
- The cover to the rear is one sandbag high and one M203 long.
- If logs are used, they must be held firmly in place with strong stakes.
- The leader inspects the retaining wall.

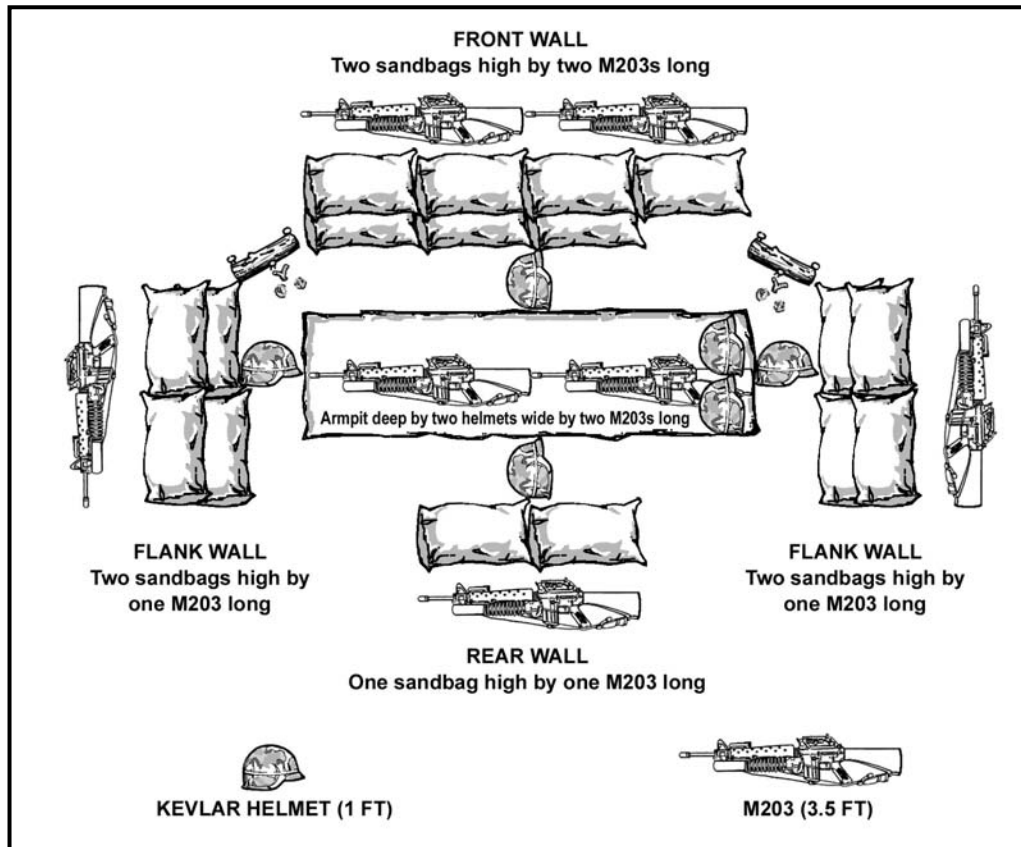

Figure 5-25. Stage 2, Preparations of a fighting position.

STAGE 3: Soldiers dig the position and throw dirt forward of the parapet retaining walls and pack it down hard (Figure 5-26, page 5-50). They—

- Dig the position armpit deep (tallest soldier).
- Fill the parapets in order of front, flanks, and rear.
- Camouflage the parapets and the entire position.
- Dig grenade sumps and slope the floor toward them.
- Dig storage areas for the two rucksacks into the rear wall if needed.
- Ensure the leader inspects the work.

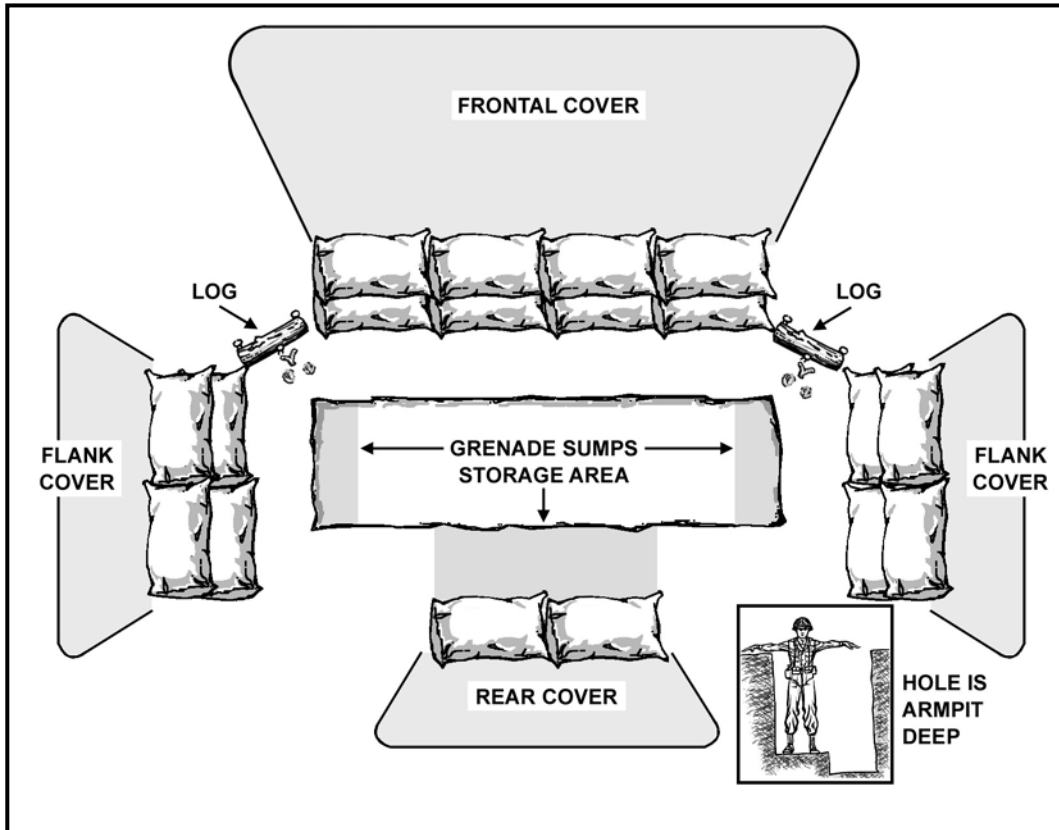

Figure 5-26. Stage 3, Preparations of a fighting position.

STAGE 4: Soldiers prepare the overhead cover (Figure 5-27). They—

- Always provide solid support for overhead cover. Build the support using 4 to 6-inch logs on top of each other running the full length of the front and rear cover.
- Place five or six logs 4 to 6 inches in diameter and two M203s long over the center of the position, resting them on the overhead cover support, not the sandbags.
- Place waterproofing (plastic bags, ponchos) on top of these logs.
- Put a minimum of 18 inches of packed dirt or sandbags on top of the logs.
- Camouflage the overhead cover and the bottom of the position.
- Ensure the leader inspects the position.

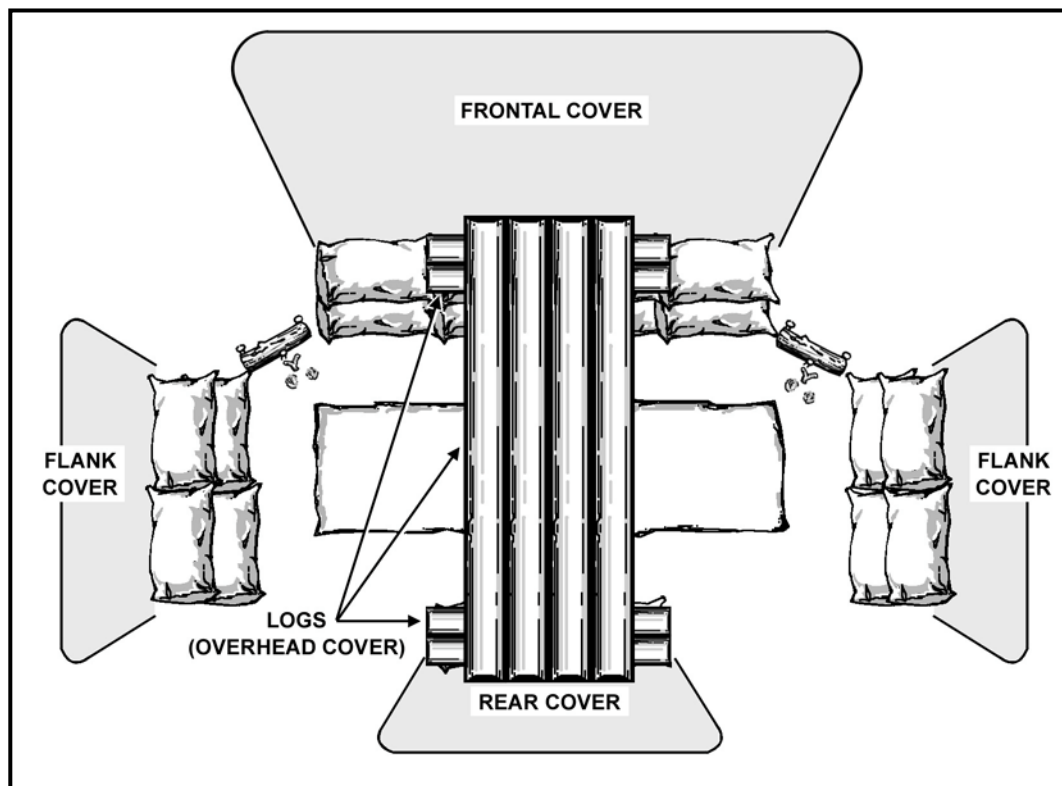

Figure 5-27. Stage 4, Preparations of a fighting position.

c. **Leaders Inspect All Positions.** Leaders must ensure their soldiers build fighting positions that are both effective and safe. An improperly sited position cannot be used and an improperly constructed position is a danger to its occupants.

5-39. STANDARD DESIGNS

When expecting an immediate enemy attack, Infantrymen dig hasty fighting positions. As time becomes available, these are improved, enlarged and strengthened, a process that continues as long as the unit occupies a defensive position. Because the battlefield conditions confronting Infantrymen are never standard, there is no single standard fighting position design that fits all tactical situations.

a. Sometimes, soldiers must construct fighting positions using only the basic tools and materials they can carry or find in the local area, such as entrenching tools, sandbags and locally cut timber. At other times, significant amounts of Class IV construction materials and heavier digging tools may be available.

b. At times, the terrain will accommodate the construction of a position with overhead cover that protects soldiers from indirect fire fragmentation while allowing them to return fire. Sometimes, especially on open terrain, this is not possible and the entire position must be built below ground level. Although this type position offers excellent protection and concealment to soldiers, it limits their ability to return fire from within a protected area.

c. Infantry fighting positions are normally constructed to hold one, two, or three soldiers. There are special designs adapted for use by machine gun (M240B) and

antiarmor (Javelin) teams. Fighting vehicles in hull- and turret-defilade positions should be integrated into the platoon's defense, although not necessarily adjacent to infantry positions

NOTE: Regardless of the position design, the type of construction materials, the tools available, or the terrain, all fighting positions must incorporate sound engineering construction principles. Unless it is constructed properly, a fighting position can easily collapse and crush or bury the soldiers within. FM 5-103 and FM 5-34 provide excellent information on these principles. Additionally, GTA 05-08-001 and GTA 07-06-001 contain detailed information in easy to use formats.

- d. When constructing fighting positions, soldiers should:
- Dig the positions no deeper than armpit deep.
 - Fill sandbags no more than 75 percent full.
 - Use revetments to support excavations in sandy soil.
 - Check stabilization of wall bases.
 - Inspect and test the position daily, after heavy rain, and after receiving fire.
 - Maintain, repair, and improve positions constantly.
 - Keep all vehicles at least five meters away from the position.

5-40. TYPES OF FIGHTING POSITIONS

There are many different types of fighting positions. The number of occupants; types of weapons; tools, materials, and time available; and terrain dictate the type of position.

a. **Hasty Fighting Position.** Soldiers prepare hasty fighting positions when there is little or no time before contact with the enemy is expected (Figure 5-28). They locate them behind whatever cover is available and where they can engage the enemy. The position should give frontal protection from direct fire while allowing fire to the front and oblique. Occupying a hasty position does not mean there is no digging. Soldiers can dig hasty positions in only a few minutes. A hasty fighting position just 18 inches deep will provide a significant amount of protection from direct fire and even fragmentation. Hasty positions may be the first step in the construction of more elaborate positions.



Figure 5-28. Hasty fighting position.

b. **One-Soldier Fighting Position.** Positions that contain only a single soldier are the least desirable, but they are useful in some situations. They may be required to cover exceptionally wide frontages. They should never be positioned out of sight of adjacent positions. The one-soldier position allows choices in the use of cover. The hole only needs to be large enough for one soldier and his gear. It does not have the security of a two-soldier position. The one-soldier fighting position (Figure 5-29) should allow the soldier to fire to the front or to the oblique from behind frontal cover.



Figure 5-29. One-soldier fighting position.

c. **Two-Soldier Fighting Position.** A two-soldier fighting position (Figure 5-30, page 5-54) is normally more effective than a one-soldier position. It can be used to provide mutual support to adjacent positions on both flanks as well as cover dead space immediately in front of the position. One or both ends of the hole may extend around the sides of the frontal cover. Modifying a position in this way allows both soldiers to have better observation and to have greater fields of fire to the front. Also, during rest or eating periods, one soldier can watch the entire sector while the other sleeps or eats. If they receive fire from their front, they can move back to gain the protection of the frontal cover. By moving about 1 meter, the soldiers can continue to find and hit targets to the front during lulls in enemy fire. This type of position requires more digging and is harder to camouflage. It also provides a better target for enemy hand grenades.



Figure 5-30. Two-soldier fighting position.

d. **Three-Soldier Fighting Position.** A three-soldier position has several advantages. A leader can be in each position, making command and control easier. It supports continuous security operations better than other positions. One soldier can provide security; one can do priority work; and one can rest, eat, or perform maintenance. This allows the priority of work to be completed more quickly than in a one- or two-soldier position. This position allows the platoon to maintain combat power and security without shifting personnel or leaving positions unmanned. It provides 360-degree observation and fire, and it is more difficult for the enemy to destroy because he must kill or suppress three soldiers.

(1) When using three-soldier positions, the leader must consider several things. Either the distance between positions must be increased or the size of the squad's sector must be reduced. The choice depends mainly on visibility and fields of fire. Because the squad leader is in a fighting position that will most likely be engaged during the battle, he cannot exert personal control over the other two positions. The squad leader controls the battle by—

- Clearly communicating his plans and intent to his squad to include control measures and fire plans.
- Using prearranged signals like flares, whistles, or tracers.
- Positioning key weapons in his fighting position.
- Placing his fighting position so it covers key or decisive terrain.
- Placing his fighting position where his team might be able to act as a reserve.

(2) The three-soldier emplacement is a T-position. This basic design can be changed by adding or deleting berms, changing the orientation of the T, or shifting the position of the third soldier to form an L instead of a T (Figure 5-31). The layout of the position can be oriented to fire on expected enemy avenues of approach from any direction. Berms

must not block observation or fire into assigned primary or alternate sectors. Care must be taken to properly support the overhead cover.

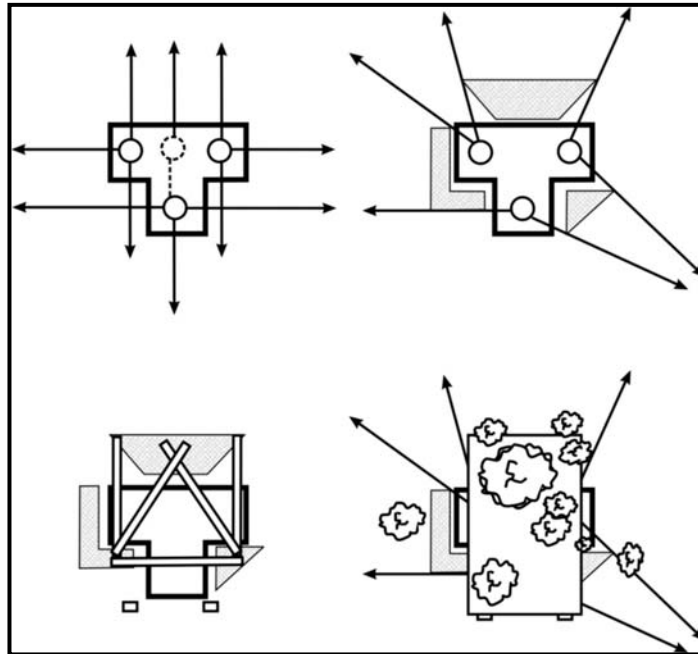

Figure 5-31. Three-soldier T-position.

e. **Machine Gun Position.** The primary sector of fire is usually to the oblique so a machine gun can fire across the platoon's front. The tripod is used on the side covering the primary sector of fire. The bipod legs are used on the side covering the secondary sector of fire. When changing from primary to secondary sectors, the gunner moves only the machine gun. Occasionally a sector of fire that allows firing directly to the front is assigned, but this can reduce the frontal cover for the crew when firing to the oblique (Figure 5-32). (For a detailed discussion on the employment of the M240B refer to Appendix B)

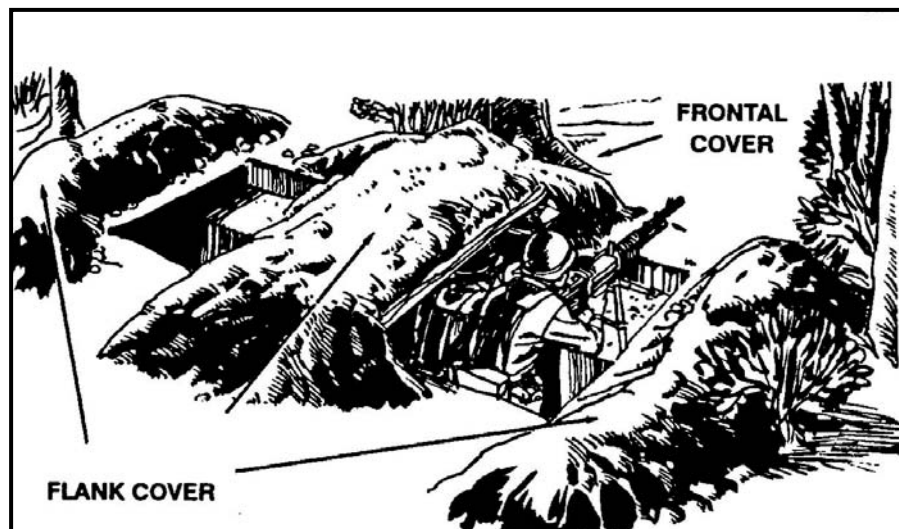

Figure 5-32. Machine gun position.

(1) After the platoon leader positions the machine gun, he marks the position of the tripod legs and the limits of the sectors of fire. The crew then traces the outline of the hole and the frontal cover (if it must be improved).

(2) The crew digs firing platforms first to lessen their exposure in case they must fire before they complete the position. The platforms must not be so low that the gun cannot be traversed across its entire sector of fire, reducing the profile of the gunner when firing and reducing the frontal cover height.

(3) After digging the firing platforms, the crew digs the hole. They first place the dirt where frontal cover is needed, digging the hole deep enough to protect them and still allow the gunner to fire with comfort (usually about armpit deep). When the frontal cover is high enough and thick enough, the crew uses the rest of the dirt to build flank and rear cover. Trench-shaped grenade sumps are dug at various points so either soldier can kick a grenade into one if needed. Overhead cover for a machine gun position is built the same as for a two-soldier position.

NOTE: In some positions, a machine gun might not have a secondary sector of fire. In this case, dig only half the position.

(4) When there is a three-soldier crew for a machine gun, the ammunition bearer digs a one-soldier fighting position to the flank that is connected to the gun position by a crawl trench. From his position, the ammunition bearer can see and fire to the front and to the oblique. Usually, the ammunition bearer is on the same side as the FPL or PDF. This allows him to see and fire his rifle into the machine gun's secondary sector and to see the gunner and assistant gunner.

f. **Javelin Position.** The Javelin can be employed from hasty or completed positions (Figure 5-33). However, some changes are required. (For a detailed discussion on the employment of the Javelin refer to Appendix F)



Figure 5-33. Javelin position.

(1) The gunner must keep the weapon at least 6 inches above the ground to allow room for the stabilizing fins to unfold. The hole is only waist deep to allow the gunner to move while tracking a target. Because the Javelin gunner must be above ground level, the frontal cover should be high enough to hide his head and, if possible, the backblast of the Javelin. A hole is dug in front of the position for the bipod legs.

(2) When the Javelin can be fired in one direction only, the position is adjusted to have cover and concealment from all other directions, and it should be fired to the oblique. This protects the position from frontal fire and allows engagement of the target from the flank. Both ends of the launcher must extend out over the edges of the hole.

(3) Overhead cover must be built on the flanks. Cover must be large enough for the gunner, the tracker, and the missiles. Overhead cover that allows fire from underneath can be built if the backblast area is clear. Overhead cover must be well camouflaged.

(4) The Javelin is an important weapon and is easy to detect, therefore selection and preparation of alternate positions have a high priority. When preparing an alternate position, the gunner should select and improve a covered route to it so he can move to the position under fire.

g. **AT4.** The AT4 can be fired from infantry fighting positions. If the AT4 is to be fired from a two-soldier position, the gunner must ensure the other soldier is not in the backblast area. The front edge of a fighting position is a good elbow rest to help the gunner steady the weapon and to gain accuracy. When firing the AT4, the gunner leans against the rear wall. His elbows are not supported.

5-41. VEHICLE POSITIONS

Vehicles use natural cover and concealment in hide positions initially to increase survivability. As time, assets, and situation permit, positions are prepared using organic excavation equipment or engineer support. Priority is given to those vehicles containing essential equipment or supplies. Crews use these fighting positions for individual protection as well.

a. Parapets positioned at the front of or around major weapon systems provide improved protection from direct fire and from blast and fragments of indirect fire, artillery, mortar, and rocket shells. At its base, the parapet should be at least 8 feet thick. The parapet functions as a standoff barrier for impact-detonating direct fire HEAT and ATGM projectiles. The parapet should cause the fuzes to activate, thereby increasing survivability for the protected vehicles. If the enemy uses kinetic energy, direct fire armor-piercing, or hypervelocity projectiles, it is impractical to construct parapets thick enough for protection. To protect against these projectiles, deep-cut, hull defilade, or turret defilade positions are prepared. Fighting and protective positions for essential vehicles should be constructed no larger than needed.

b. Battlefield success requires maneuver among fighting positions between main gun firings. Maximum use of terrain is required to conceal fighting vehicles maneuvering among fighting positions. After a major weapon system fires its main gun, the vehicle should move concealed to another position before firing again. If the major weapon system immediately reappears in the old position, the enemy knows where to fire his next round.

(1) Hasty fighting positions for combat vehicles, including armored personnel carriers (APCs) and mortar carriers, take advantage of natural terrain features. These positions are prepared with a minimum of construction effort. A frontal parapet, as high as practical without interfering with the vehicle's weapon systems, shields the position from frontal attack and provides limited concealment if properly camouflaged. Protection is improved if the position is made deeper and the parapet extended around the vehicle's sides. Parapets provide a false sense of security against kinetic energy and hypervelocity

projectiles; therefore, hasty vehicle fighting positions with parapets are not recommended for tanks and BFVs. Hasty fighting positions offer protection from HEAT projectiles and provide limited concealment if properly camouflaged. As the tactical situation permits, hasty positions are improved to deliberate positions.

(2) Deliberate fighting positions are required to protect a vehicle from kinetic energy and hypervelocity projectiles. The position is constructed in four parts: hull defilade, concealed access ramp or route, hide location, and turret defilade (Figures 5-34, 5-35, and 5-36).

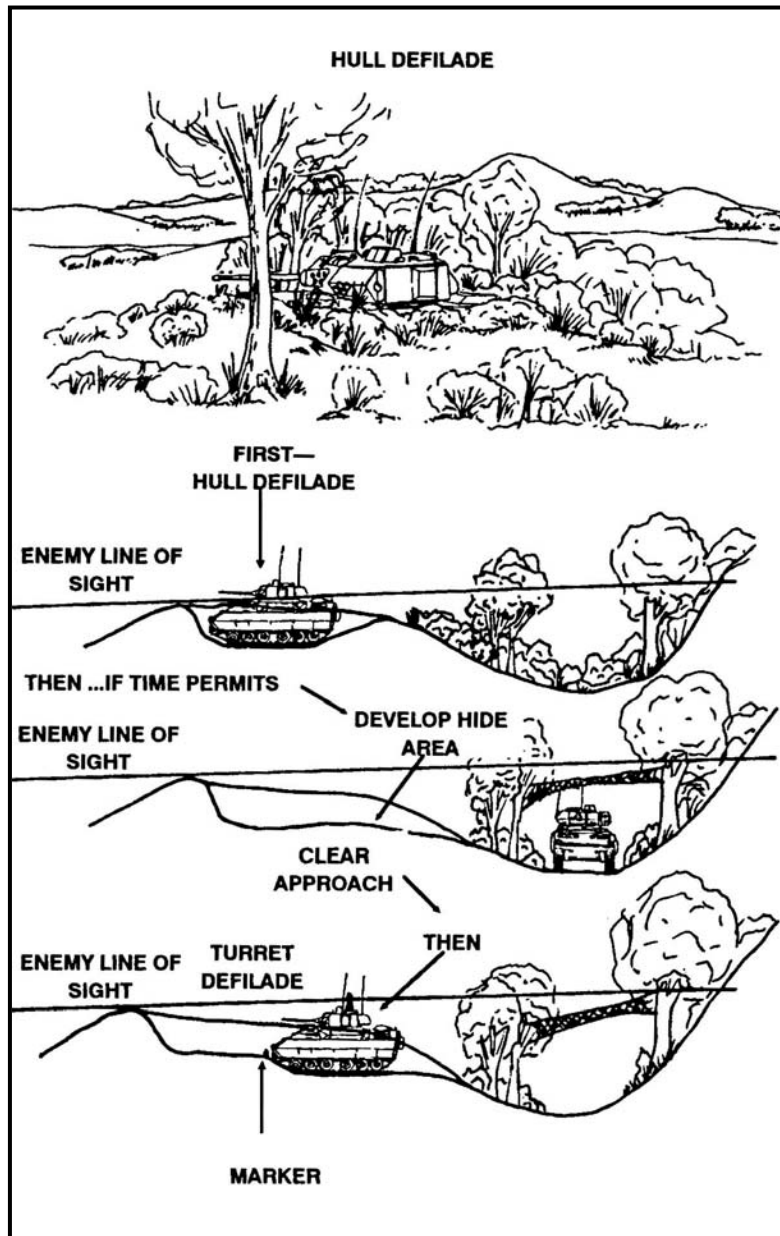

Figure 5-34. Developing deliberate fighting positions.

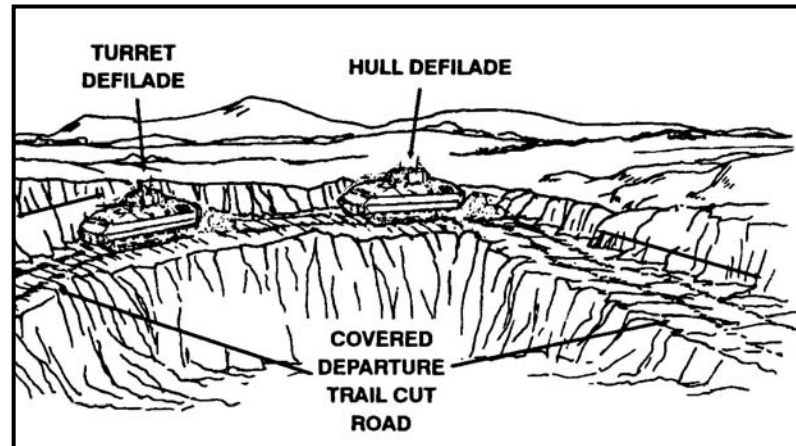

Figure 5-35. Enhanced natural position.

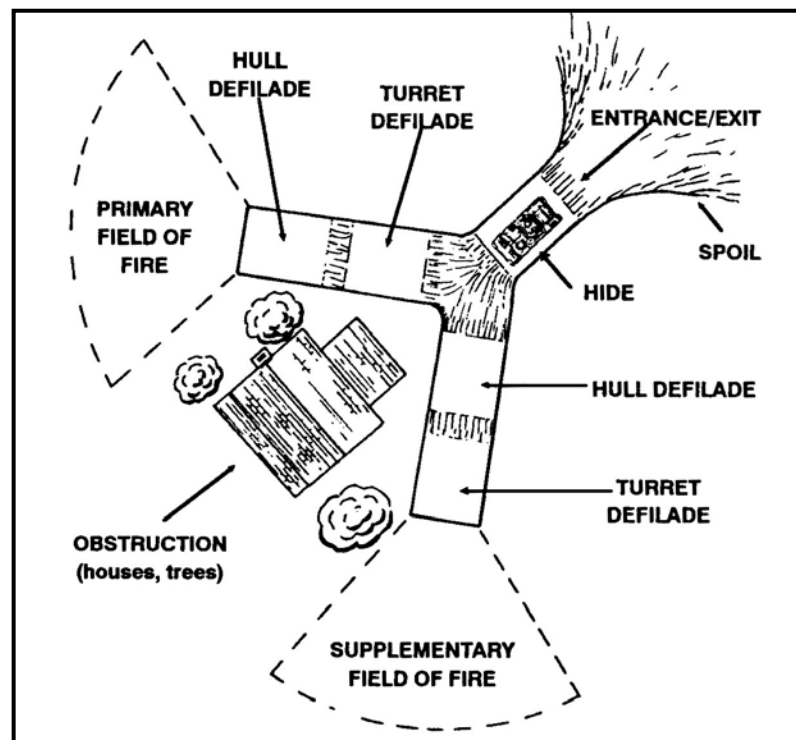

Figure 5-36. Top view of Y-shaped fighting position.

c. Positions formed by natural terrain are best because they are easy to modify. If preparation is necessary, extensive engineer support is required. Each position is camouflaged with either natural vegetation or a camouflage net, and the spoil is flattened out or hauled away. All fighting positions for fighting vehicles (tanks, BFVs) are planned as deliberate positions. Since the lack of time usually does not allow full construction of a deliberate position, only some parts of the position are prepared. For example, the complete fighting position for a BFV requires the construction of a hull defilade, turret defilade, concealed access ramp or route, and hide location all within the same position.

The maneuver team commander uses organic and engineer earthmoving assets and usually constructs part of the fighting position.

d. Digging hide locations and concealed routes between fighting positions is normally not practical due to the lack of engineer assets and time. Engineer assets are used to dig the hull and turret defilade positions. The ramps and concealed routes require only partial clearing and leveling with blade tanks or engineer equipment because natural concealed routes and hide locations are used. If time permits, the commander expands the fighting position to all four parts, including a hide and turret defilade location. The access ramp from the hide location to the hull defilade position usually provides turret defilade for a vehicle at some point on the ramp. This location can be marked with engineer tape and a chemical light so the driver knows when to stop.

5-42. TRENCHES

When there is time and help available, trenches should be dug to connect fighting positions so soldiers can move by covered routes. The depth of a trench depends on the type of help and equipment available. Without engineer help, platoons dig crawl trenches (about 3 feet deep by 2 feet wide) With engineer help, they dig standard trenches. The trench should zigzag so the enemy cannot fire down a long section. Platoons normally dig crawl trenches because engineer assets are usually limited. Platoons use crawl trenches to conceal their movement into and within positions to provide minimum protection. Spoil is placed on parapets, normally on each side of the trench. If the trench runs across a forward slope, all the spoil is placed on the enemy side to make the forward parapet higher. All spoil needs careful concealment from enemy direct observation (Figure 5-37).



Figure 5-37. Crawl trenches.

CHAPTER 6

URBAN OPERATIONS

Throughout history military planners have viewed cities as centers of gravity and sources of national strength. Cities are population centers; transportation and communication hubs; key sites of industrial, financial, and information systems; seats of government; and repositories of wealth. Because the US has worldwide interests that directly relate to global security, deployments into urban environments are likely to become more frequent. These urban operations will serve a variety of tactical purposes: to neutralize or stabilize extremely volatile political situations; to defeat an enemy force that has sought the protection afforded by urban terrain; to provide assistance to allies in need of support. This chapter describes techniques, procedures, and special considerations that platoons and squads will use throughout the planning and execution of operations in an urban environment.

Section I. OFFENSE

While operating in urban areas, the major offensive collective tasks at platoon and squad level are attacking and clearing buildings. This involves isolating the objective, suppressing the enemy, advancing the assault element, assaulting the building, clearing the building, and consolidating and reorganizing the force.

Regardless of the type of urban area or its structural characteristics, there are six interrelated requirements for attacking a defended building:

- Isolation of objective.
- Supporting fires.
- Tactical movement.
- Conduct the breach.
- Conduct the assault.
- Consolidation and reorganization.

Proper application and integration of these requirements reduces casualties and hastens accomplishment of the mission. The type of building to be assaulted, the ROE, and the nature of the surrounding urban area will determine the method of execution. For example, medium-size towns have numerous open spaces, and larger cities have high-rise apartments and industrial and transportation areas that are separated by parking areas or parks. Increased fire support is required to suppress and obscure enemy observation and fires that may be covering the open terrain and spaces between buildings. Conversely, the centers of small- and medium-sized towns, with twisting alleys and narrow roads or adjoining buildings, provide numerous covered routes that can decrease fire support requirements.

Platoon and squad leaders must consider the assigned task, its purpose, and the method they will use to achieve the desired results. The leader may not need to commit troops into a structure or close with the enemy in order to seize or gain control of a building, a group of buildings, or an area. For example, if the enemy personnel have low morale or are poorly trained, under equipped, or lack leadership, they may be convinced

to surrender or depart from the premises simply by a show of force and the use of a skilled PSYOPS team. At the other end of the spectrum is the well-trained enemy that is prepared to defend and has the means to resist. In this case the leader may decide (ROE permitting) to concentrate his direct and indirect fire weapons and other combat support systems onto the objective area in order to neutralize the enemy without maneuvering troops to conduct an assault.

6-1. TASK ORGANIZATION (PLATOON ATTACK OF A BUILDING)

When conducting offensive urban operations, the company commander normally organizes the company into two elements: an assault element and a support element. The mission to breach is METT-TC dependent and normally will be conducted by personnel within the assault element. If engineers are available, they will be task-organized into the assault element. The support element or an adjacent company, if part of a battalion effort, isolates the objective area (security).

As part of the company assault element, the platoon organizes into three assault squads with two assault teams each. It will likely attach one machine gun to the company support element and maintain two machine guns for close support within the assault element. As the company's support element, the platoon may be organized into three support squads and two BFV sections supplemented with machine guns and antiarmor weapons for increased lethality.

Platoons seldom perform independent operations in urban areas, but they may become separated or isolated during combat operations. This paragraph discusses the methods a platoon uses when required to conduct independent offensive urban operations. The platoon leader normally will organize his platoon into at least two elements: an assault element and a support element (Figure 6-1). Engineers attached to the assault element may conduct the breaching task. If engineers are not available, the platoon leader may designate a breaching team from within either the assault or the support element or, depending on the situation, he may task organize a separate breach element. The platoon leader determines the size and composition of these elements based on the mission, the number of troops available, the type and size of the objective building, whether the adjacent terrain provides open or covered approaches, and the organization and strength of the enemy defenses.

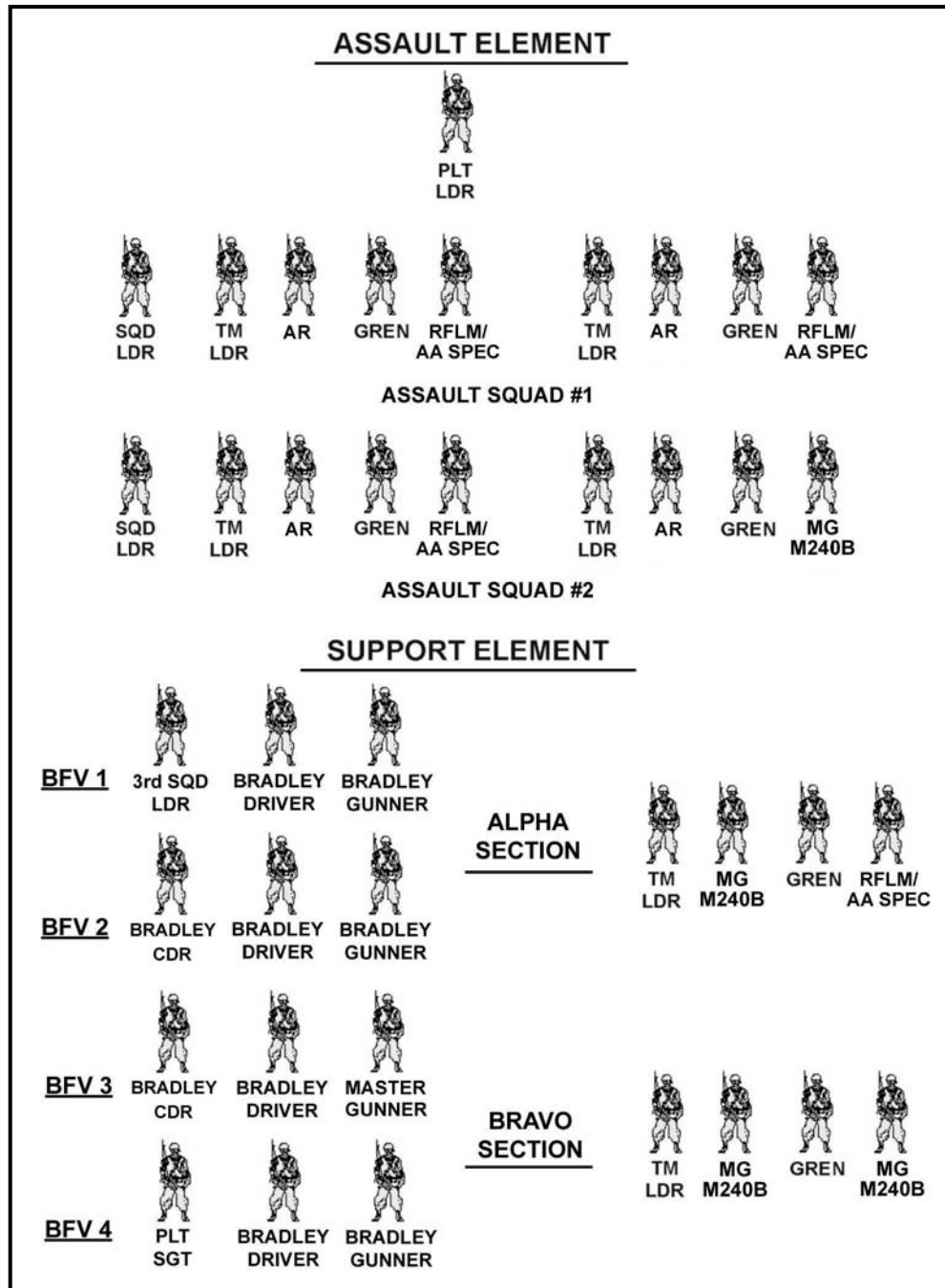

Figure 6-1. Platoon organization.

a. **Assault Element.** The purpose of the assault element is to kill, capture, or force the withdrawal of the enemy from any urban objective, and to seize key terrain. The assault element of a platoon may consist of one, two, or three squads. Squad leaders normally organize their two fire teams into two clearing teams or, in special circumstances, the squad may be kept as a single assault squad.

NOTE: Clearing techniques are designed to be executed by the standard four-man fire team. This does not mean that all four members must enter a room in order to clear it. Because of the confined spaces typical of building and or room clearing operations, units larger than squads quickly become awkward and unmanageable. When shortages of personnel demand it, two- and three-man teams can conduct room-clearing operations, but four-man teams are best suited to this task. Using fewer personnel adds to the combat strain and greatly increases the risk to the team. For clearing large open buildings, such as hangars or warehouses, it may be necessary to use two squads simultaneously, employing bounding overwatch, to effectively clear the entire structure and to provide force protection.

b. **Support Element.** The purpose of the support element is to provide immediate suppressive fire support to enable the assault element to close with the enemy. Normally, the BFV will be the primary support by fire weapons system for the platoon. The supporting fires must be closely controlled to avoid excessive expenditure of ammunition and to prevent fratricide. At platoon level, the platoon sergeant controls the support element, which consists of the platoon's BFVs, antitank weapons systems, and any personnel not designated as part of the assault element. (Usually one squad remains with the BFVs to provide security for the vehicles.) The support element provides direct fire support and other assistance to advance the assault element. This assistance includes, but is not limited to, the following:

- Suppressing enemy weapons systems and obscuring the enemy's observation within the objective building(s) and adjacent structures.
- Isolating the objective building(s) with direct fires to prevent enemy withdrawal, reinforcement, or counterattack.
- Obscuring enemy observation of obstacles en route to and at the entry point to the objective during breaching operations.
- Destroying or suppressing enemy positions with direct fire weapons.
- Engaging enemy armor with antitank weapons.
- Securing cleared portions of the objective.
- Providing replacements for the assault element.
- Providing the resupply of ammunition and pyrotechnics.
- Bringing up specific equipment that the assault element could not carry in the initial assault.
- Evacuating casualties, prisoners, and civilians.

NOTE: The platoon sergeant must be prepared to rapidly evacuate the wounded from the objective area to the company casualty collection point (CCP). The use of ground ambulances may be impeded by rubble in the streets, barricades, and demolition of roads; therefore, litter teams could be used extensively. Additionally, snipers can affect medical evacuation from forward positions.

c. **Breach Team.** The purpose of the breach team is to clear and mark lanes through obstacles during movement and to provide the assault element with access to an urban objective. The platoon leader organizes the force to ensure that breaching teams are

identified. One technique is to assign one fire team from the assault element as the breaching team. The breach can also be conducted using an attached engineer or any member of the platoon who has had additional training in breaching techniques.

6-2. MOVEMENT

When moving in an urban area, squads and platoons use modified variations of the traveling, traveling overwatch, and bounding overwatch movement techniques. Often squads and fire teams will use the modified wedge (file or column) to move. Leaders must be aware of the three-dimensional aspect of urban terrain such as streets, buildings, subsurface, and airspace (Figure 6-2). Squads and platoons are extremely vulnerable to sniper fire; therefore, to prevent excess casualties, countersniper techniques must be well rehearsed and implemented. (See FM 3-06.11 for more information concerning countersniper techniques.)

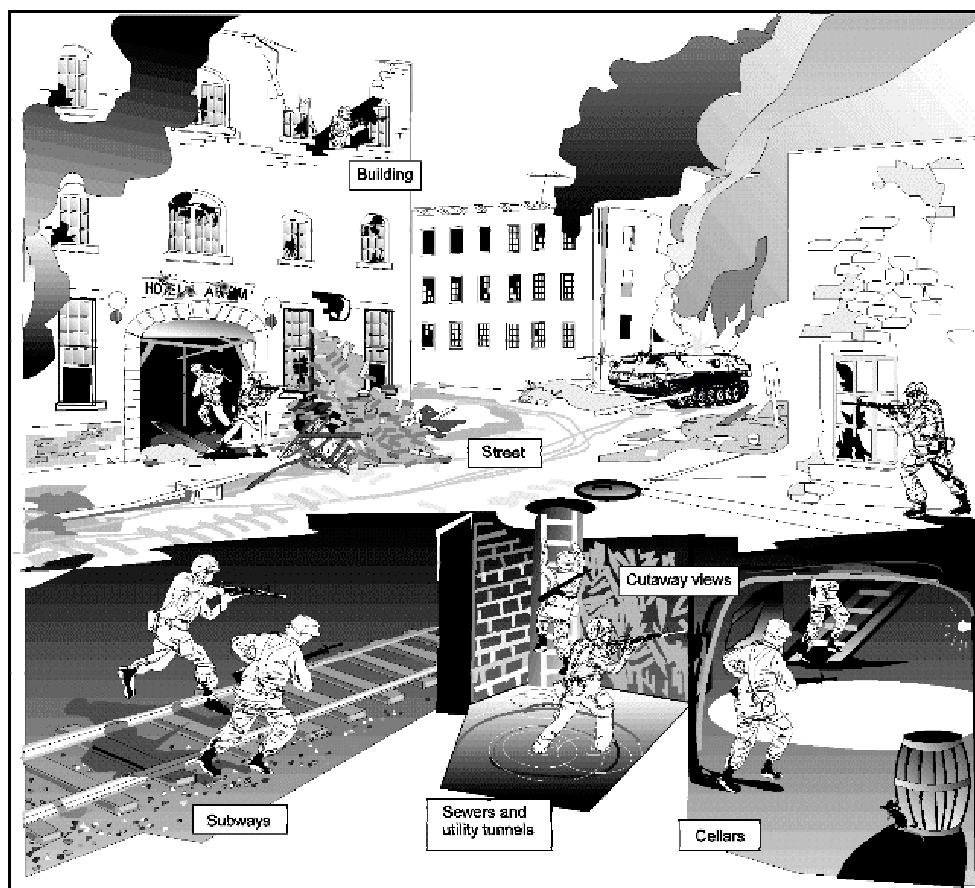

Figure 6-2. Three-dimensional urban terrain.

a. In house-to-house and street fighting, the BFVs move along streets protected by the infantry, which clears the area of enemy antitank weapons. The BFVs in turn support the infantry with their 25-mm cannon and 7.62-mm coaxial machine gun (Figure 6-3, page 6-6). The BFV can also provide smoke obscuration with the M257 smoke grenade

launcher. The L8A1/A3 red phosphorus smoke grenade will last for 1 to 3 minutes, while the M76 infrared screening grenade provides obscuration for 30 to 60 seconds.

b. The assault force (squad or platoon) minimizes the effects of the enemy's defensive fires during movement by:

- Using covered and concealed routes.
- Moving only after enemy fires have been suppressed or enemy observation obscured.
- Moving at night or during periods of reduced visibility.
- Selecting routes that will not mask friendly suppressive fires.
- Cross open areas quickly under the concealment of smoke and suppression provided by the support element.
- Moving on rooftops not covered by enemy fires.

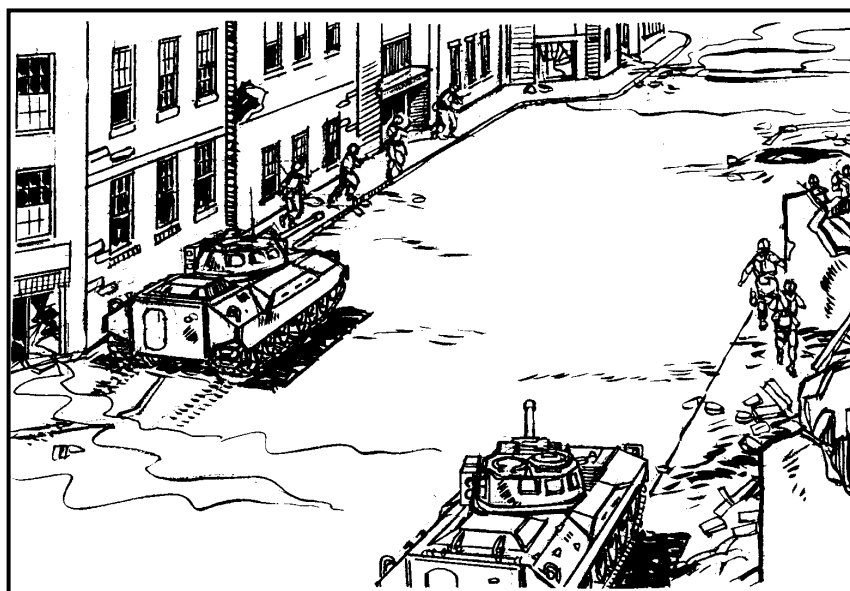

Figure 6-3. BFVs provide cover for rifle squads.

c. In lightly defended areas, the type of operation may dictate moving along streets and alleys without clearing all the buildings.

d. To avoid exposure on the street or to provide mutual support, the infantry squads should move through the buildings, if possible.

e. The platoon moves along streets and alleys with two squads leading, one on either side of the street, supported by BFVs in the overwatch. The squads should move using bounding overwatch to quickly locate, identify, engage, and eliminate all enemy antiarmor weapon systems.

NOTE: When employing armored vehicles along side the infantry assault, leaders must be aware of the explosive effects and fragmentation fallout, as well as the blast over pressure, and how it will affect the infantry on the ground. (For more specific information on the effects of weapons see FM 3-06.11.)

6-3. ASSAULTING A BUILDING

The assault element, regardless of size, must quickly and violently execute the assault and subsequent clearing operations. Once momentum has been gained, it is maintained to deny the enemy time to organize a more determined resistance on other floors or in other rooms. The small unit leaders are responsible for maintaining the momentum of the assault yet not allowing the operation to become disorganized. Obstacles may slow or stop forward movement. Leaders must maintain the momentum by rapidly creating a breach in the obstacle, or by redirecting the flow of the assault over or around the obstacles.

a. **Approaches.** All routes to the breach and or entry point are planned in advance. The best route is confirmed and selected during the leaders' reconnaissance. The route should allow the assault element to approach the breach (entry) point from the blind side, if possible.

b. **Order of March.** The assault team's order of march to the breach point is determined by the method of breach and their intended actions at the breach (entry) point. This preparation must be completed prior to or in the last covered and concealed location before reaching the breach (entry) point. Establishing an order of march aids the team leader with C2 and minimizes exposure time in open areas and at the entry point. An order of march technique is to number the assault team one, two, three, and four. The number-one man should always be responsible for frontal and or door security. If the breach has been conducted prior to their arrival, the assault team quickly moves through the breach (entry) point. If a breach has not been made prior to their arrival at the breach (entry) point, and depending on the type of breach to be made, the team leader conducts the breach himself or signals forward the breach man or element. One option is to designate the squad leader as the breach man. If the breach man is part of the assault team, he will normally be the last of the four men to enter the building or room. This allows him to transition from his breaching task to his combat role. (See FM 3-06.11 for more information concerning movement and breaching methods.)

(1) **Explosive Breach.** A suggested order of movement for an explosive breach without engineer support is; number-one, number-three (team leader), number-two, and then number-four man. The number-one man provides security at the entry point. The number-three man (team leader) carries the demolition charge and places it. Number-four provides rear security. After the demolition charge is placed, team members re-form in their original configuration and take cover around a corner or behind other protection. Team members can line up on either or both sides of the entry point, if there is adequate protection from the blast.

(2) **Ballistic Breach (Small Arms).** A suggested order of movement for a ballistic (small arms) breach places the gunner up front, followed by the number-one man, number-two man, and then the number-three man (team leader). After the door is breached, the gunner moves to the rear of the lineup and assumes the position of the number-four man.

(3) **Mechanical Breach.** A suggested order of movement for a mechanical breach is the initial assault team in order, followed by the breach man or element. At the breach point the team leader brings the breach element forward while the assault team provides local security. After the breach is made, the breach element moves aside and provides local security while the assault team enters the breach.

c. **Security.** Because of the three-dimensional threat associated with urban terrain, the assault element must maintain 360-degree security during movement to the breach (entry) point. If the assault element is to stop in the vicinity of the breach (entry) point to wait for the breach element to complete its task, the support element must maintain suppressive fire to protect the assault element.

d. **Assault Locations.** Entry at the top and fighting downward is the preferred method of clearing a building (Figure 6-4). This forces the defenders down and out of the building where the support element can engage them. This method is only feasible, however, when access to an upper floor or rooftop can be gained either from the windows or roofs of adjoining, secured buildings or by using a ladder. Rooftops are treated as danger areas when surrounded by higher buildings from which enemy forces could engage the assault element. Troops breach the roof or common walls to gain entrance into the building. (If using explosives on the rooftop, ensure cover is available to the soldiers.) They may use ropes or other means to enter the lower floors through the holes created during the breach.

NOTE: Soldiers should consider the use of devices and other techniques that allow them upper level access without using interior stairways. Those devices and techniques include, but are not limited to, adjacent rooftops, fire escapes, portable ladders, and various soldier-assisted lifts. (See FM 3-06.11.)



Figure 6-4. Assault element entering through upper level.

e. **Support Element.** The support element isolates the building with direct and indirect fires to support the assault element's move to the breach point. The support element covers mounted avenues of approach with antiarmor weapons and covers dismounted avenues of approach with automatic weapons. It suppresses enemy fires and

neutralizes enemy positions within the objective building and adjacent buildings as the breach team and assault element move into position. The support element eliminates any enemy trying to exit the building. The location of adjacent units must be considered in the emplacement of supporting fires.

(1) The support element uses smoke to obscure the movement of the breach and assault element to the building. If possible, the smoke obscuration is maintained until the assault element has entered the building.

(2) Depending upon the ROE, just before the maneuver of the assault element, the support element increases suppressive fires on the objective and continues until masked by the advancing assault element. (See Figure 6-5, page 6-10, for fire control technique.) Once masked, the support element shifts fires to upper or lower windows and continues until the assault element has entered the building. At that time, they shift fires to adjacent buildings to prevent enemy withdrawal or reinforcement.

(3) If the ROE are very restrictive, the use of supporting fires may be restricted to known enemy locations that have engaged the unit.

(4) The support element must also deal with civilians displaced by the assault, EPWs, and casualties.

f. **Direction of Assault Technique of Direct Fire Planning and Control.** In this technique, building numbers are assigned in a consistent pattern in relation to the direction of assault. In the example shown in Figure 6-5, page 6-10, the buildings are numbered consecutively, in a counterclockwise manner. Further, the sides of the buildings are color-coded consistently throughout the objective area (WHITE—direction of assault side; GREEN—right side; BLACK—rear side; RED—left side; BLUE—roof). An odd-shaped building is also shown. Note that a “four-sided” concept was retained to minimize confusion. Further designations of WHITE 1, WHITE 2, WHITE 3, and so on from left to right can be added to specify which wall will be engaged. Apertures on the buildings are also labeled consecutively using rows and columns, as shown. In the example, “OBJ 4, WHITE, window A1” is the lower left-hand window on the direction of assault side of OBJ 4. All designations are labeled in relation to the direction of assault. (See FM 34-130 for additional information on building shapes and structural labeling.)

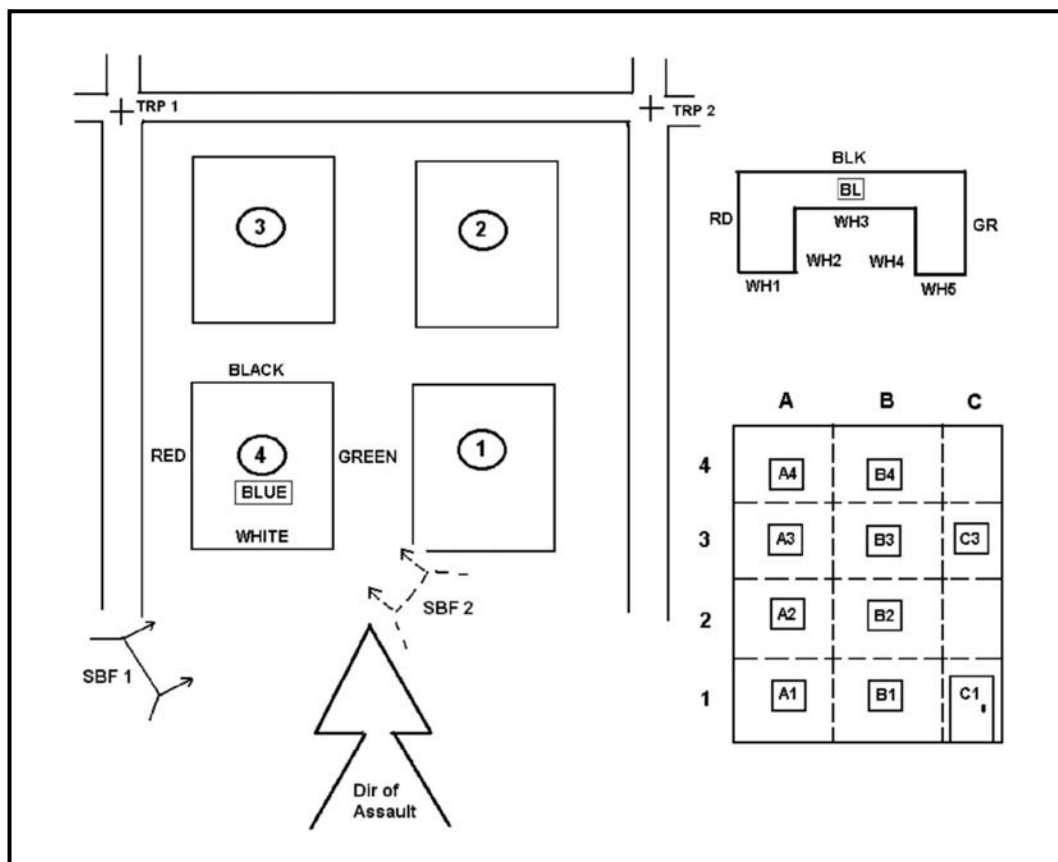

Figure 6-5. Direction of assault technique of fire control.

6-4. CONDUCT OF THE BREACH

Soldiers may be fighting just to get to the breach point; therefore, proper fire and movement will be required all the way to the breach (entry) point. To start the violence of action needed to enter the building, consider firing into windows and doors or throwing fragmentation grenades, concussion grenades, or stun grenades into the room to be cleared, if the ROE allows. (While fragmentation and concussion grenades are effective casualty-producing weapons, the stun grenade may be used as a distraction device to provide the clearing team an extra second or two to achieve domination when entering the breach.) The rest of the squad or platoon will provide support to secure (left, right, up, and down) the assault element. Remember that the fight is three-dimensional and in 360 degrees. While it is preferable to avoid entering the room to be cleared through windows and doors, since they are usually covered by direct fire or are booby-trapped, the ROE may require using them in order to gain entry. If doors and windows are not used for the entry, the assault element must remain oriented on these danger areas as they approach the breach location. It may need to augment or create obscurity with hand-held smoke, but must remember not to mask the fires of the support element or obscure the breach (entry) point from friendly observation and fires. If possible, the breach is conducted in such a manner as to allow the assault element to continue movement without having to wait at the breach (entry) point. Deception should be used to confuse the enemy as to the location of the primary entry point. This can be achieved by using fragmentation

grenades, concussion grenades or stun grenades in an area other than the actual breach or entry point.

a. **Breaching Methods.** The three breaching methods discussed here are explosive, ballistic, and mechanical .

(1) **Explosive Breach.** This method of breaching requires the use of an explosive composition such as C4 or TNT, or a manufactured shape charge directed against the target.

(a) *Exterior Walls.* One of the most difficult breaching operations for the assault team is breaching masonry and reinforced concrete walls. Composition C4 is normally used for explosive breaching because it is safe, easy to use, and readily available. Engineers are usually attached to the platoon if explosive breaching operations are expected. The attached engineers will either conduct the breach themselves or provide technical assistance to the infantrymen involved. The typical thickness of exterior walls is 15 inches or less. Assuming that all outer walls are constructed of reinforced concrete, a rule of thumb for breaching is to place 10 pounds of C4 against the target between waist and chest height. When detonated, this charge normally blows a hole large enough for a man to go through. On substandard buildings, however, a charge of this size could rubble the building. When explosives are used to breach windows or doors, the blast should eliminate any booby traps in the vicinity of the window or doorframe. (See FM 3-06.11 for information concerning demolitions.)

(b) *Charge Placement.* Place the charges (other than shape charges) directly against the surface that is to be breached. When enemy fire prevents an approach to the wall, a technique may be to attach the breaching charge, untamped, to a pole and slide it into position for detonation at the base of the wall. Small-arms fire will not detonate C4 or TNT. Take cover before detonating the charge.

(c) *Tamping.* Whenever possible, explosives should be tamped or surrounded with material to focus the blast to increase their effectiveness. Tamping materials could be sandbags, rubble, desks, chairs, and even IV bags. For many exterior walls, tamping may be impossible due to enemy fire. An untamped charge requires approximately twice the explosive charge of a tamped charge to produce the same effect.

(d) *Second Charges.* Breaching charges will not cut metal reinforcing rods inside concrete targets. If the ROE permits, hand grenades should be thrown into the opening to clear the area of enemy. Once the area has been cleared of enemy, the reinforcing rods can be removed using special steel cutting explosive charges or mechanical means.

(2) **Ballistic Breach.** This method requires the use of a weapon firing a projectile at the breach point.

(a) For exterior walls, the use of a BFV or artillery piece in the direct fire role is ideal if the structure will support it and if the ROE will allow it. The BFV's 25-mm cannon is an effective breaching weapon when using HE rounds and firing a spiral firing pattern (Figure 6-6, page 6-12). The main gun of an M1A1/A2 tank is very effective when using the HEAT round; however, the APSD round rarely produces the desired effect because of its penetrating power. The 12-gauge shotgun breaching round is effective on doorknobs and hinges, while standard small arms (5.62-mm and 7.62-mm) have proven to be virtually ineffective for breaching. These should not be used except as a last resort because of their ricochet potential and shoot-through capability. Ballistic breaching of walls by shotgun fire is normally an alternate means of gaining entry. Ballistic breaching

is not a positive means of gaining entry and should not be considered the primary method for gaining initial entry into a structure. It may not supply the surprise, speed, and violence of action necessary to minimize friendly losses on initial entry. In certain situations, it may become necessary to use ballistic breaching as a back-up entry method. A misfire of an explosive charge or the compromise of the assault element during its approach to the target may necessitate the use of ballistic breaching as a means of initial entry into the structure. Ballistic breaching may have to be followed up with a fragmentation, concussion, or stun grenade before entry.

WARNING

The fragmentation and ricochet effects of standard small arms (5.56-mm and 7.62-mm) as breaching rounds is unpredictable and considered extremely dangerous. Do not attempt in training.

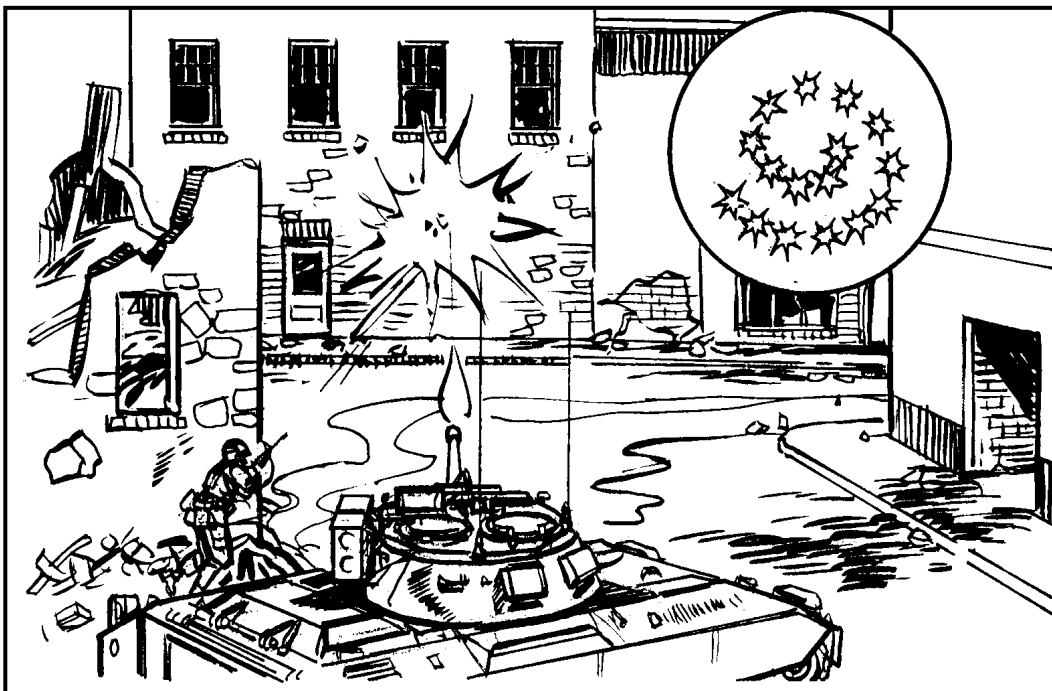

Figure 6-6. Spiral firing pattern.

(b) Once initial entry is gained, shotgun ballistic breaching may become the primary method for gaining access to subsequent rooms within the structure. Surprise is lost upon initial entry, and other breaching methods are often too slow and tend to slow the momentum of the assault team. If a door must be used for entry, several techniques can be used to open the door. Doors should be considered a fatal funnel because they are

usually covered by fire, or they may be booby-trapped. (See FM 3-06.11 for more information concerning weapon employment and effects.)

(c) Rifle-launched entry munitions (RLEM) (Figure 6-7) allow a remote ballistic breach of an exterior door or window without having the assault or breaching element physically present at the breach (entry) point. This allows the assault element to assume a posture for entry in the last covered and concealed position before the breach. The RLEM firer is not normally part of the assault element, but rather a part of the breaching or support element. This allows the RLEM to be fired from one position while the assault element waits in another position. In the event that the first round does not affect the breach, either the firer should prepare a second round for the breach or a second firer should be prepared to engage the target.



Figure 6-7. Rifle-launched entry munitions.

WARNING

Firer must be a minimum of 10 meters from target to safely employ a 150-gram round.

NOTE: Exact minimum safe distances for firers and assault elements have not been established for the 150-gram round.

(3) **Mechanical Breach.** This method requires increased physical exertion by one or more soldiers using hand tools such as axes, saws, crowbars, hooligan's tools, or sledgehammers. The mechanical breach is not the preferred primary breaching method because it may be time consuming and defeat the element of surprise. However, the ROE and the situation may require the use of these tools, so soldiers should be proficient in their use. (See FM 3-06.11 for additional information concerning mechanical breaching.)

b. **Breach Locations.** The success of the assault element often depends on the speed with which they gain access into the building. It is important that the breach location provide the assault element with covered or concealed access, fluid entry, and the ability to be overwatched by the support element.

(1) **Creating Mouseholes.** Mouseholes provide a safe means of moving between rooms and floors. C4 plastic explosive can be used to create mouseholes when lesser means of mechanical breaching fail. Because C4 comes packaged with an adhesive backing, or can be emplaced using pressure-sensitive tape, it is ideal for this purpose.

When using C4 to blow a mousehole in a lath and plaster wall, one block or a strip of blocks should be placed on the wall from neck-to-knee height. Charges should be primed with detonating cord or MDI to obtain simultaneous detonation, which will blow a hole large enough for a man to fit through.

(2) ***Expedient Breaching Methods.*** Because the internal walls of most buildings function as partitions rather than load-bearing members, smaller explosive charges can be used to breach them. When C4 or other military explosives are not available, one or more fragmentation grenades or a Claymore mine can be used to breach some internal walls. These field expedient breaching devices should be tamped to increase their effectiveness and to reduce the amount of explosive force directed to the rear. Extreme care must be taken when attempting to preform this type of breach since fragments may penetrate walls and cause friendly casualties. If walls are made of plaster (dry wall), mechanical breaching may be more effective.

(3) ***Door Breaching Charges.*** The general-purpose charge and the flexible linear charge are field-expedient charges that can be used to breach interior and exterior doors. These charges give the breach element an advantage because they can be made ahead of time and are simple, compact, lightweight, and easy to emplace. (See FM 3-06.11 for more information concerning door breaching charges.)

(4) ***Windows and Restrictive Entrances.*** Regardless of the technique used to gain entry, if the breach location restricts fundamental movement into the room or building, local or immediate support must be used until the assault team can support itself. For example, as a soldier moves through a window and into the room, he may not be in a position to engage an enemy; therefore, another window that has access to the same room may be used to overwatch the lead team's movement into the room. The overwatching element can come from the initial clearing team or from the team designated to enter the breach location second.

6-5. ENTER AND CLEAR A BUILDING

A large portion of combat in urban areas takes place at very close ranges, often between small groups of combatants within the confines of a single room. Success or failure is often determined by actions taken instinctively by individual soldiers and fire teams as they encounter complex situations. One of the complexities often encountered is the intermixing of combatants with noncombatants in the same building and often in the same rooms.

a. **Principles.** The principles of precision combat are surprise, speed, and controlled violence of action. These principles do not change regardless of ROE. The three principles of precision combat are each relative to one another—successful surprise allows increased speed; controlled violence coupled with speed increases surprise.

(1) ***Surprise.*** Surprise is one of the elements necessary for a successful assault at close range. The assault team achieves surprise by attacking at a time and location unexpected by the defender. Hand grenades, concussion grenades, or stun grenades are used to achieve surprise. These techniques are most effective against a nonalert, poorly trained enemy. An explosive or ballistic breach will also provide the element of surprise by stunning the occupants of a room.

(2) ***Speed.*** Speed provides a measure of security to the clearing unit. Speed allows soldiers to use the first few seconds provided by surprise to their advantage. In urban

combat, speed does not mean incautious haste. It can best be described as a “careful hurry.”

(3) ***Controlled Violence of Action.*** Controlled violence of action eliminates or neutralizes the enemy and decreases his chances of inflicting friendly casualties. Controlled violence of action is not limited to the application of firepower. It also involves a highly motivated soldier and his ability to dominate and control the combat situation.

b. **Fundamentals of Clearing Operations.** The fundamentals of clearing operations are the actions soldiers take while moving along confined corridors to the room to be cleared, while preparing to enter the room, during room entry and target engagement, and after contact. Team members must—

- Move tactically while securing the corridors to the room to be cleared. To prevent fatigue, noise, and interference while moving, the assault team should minimize the equipment they carry.
- If possible, arrive undetected at the entry to the room and in the correct order of entrance, prepared to enter on a single command or signal.
- Ensure security is maintained outside the room to protect the assault team inside the room.
- Enter quickly and dominate the room. They must move immediately to positions that allow complete control of the room and provide unobstructed fields of fire.
- Eliminate all enemy soldiers within the room with quick, accurate, and discriminating fires.
- Gain and maintain immediate control of the situation and all personnel in the room.
- Confirm whether enemy casualties are wounded or dead. They must search all enemy casualties, disarming them and segregating the wounded.

NOTE: Soldiers can carry and use small plastic flex cuffs to control civilian detainees or captured military personnel.

- Immediately perform a cursory search of the room and determine if a detailed search is required.
- Evacuate all wounded as quickly as possible. Friendly wounded should be evacuated as soon as they are out of direct small arms fire.
- Evacuate any friendly dead.
- Mark the room as cleared in accordance with unit SOP using simple, clearly identifiable markings (Figure 6-8, page 6-16). Some common markings can include spray paint, a reflective physical training strap, chalk, engineer tape, chem lights, and NATO marking panels. Markings may be placed on the outside of cleared floors on multistory buildings to show friendly forces the progress of the clearing operation if this will not give intelligence to enemy forces.
- Provide a SITREP in accordance with the unit SOP when the room is cleared.

- Maintain security at all times and be prepared to react to more enemy contact at any moment. Priority must be given to the direction of attack, but rear security should not be neglected.
- Rotate clearing teams to maintain the momentum of the attack.

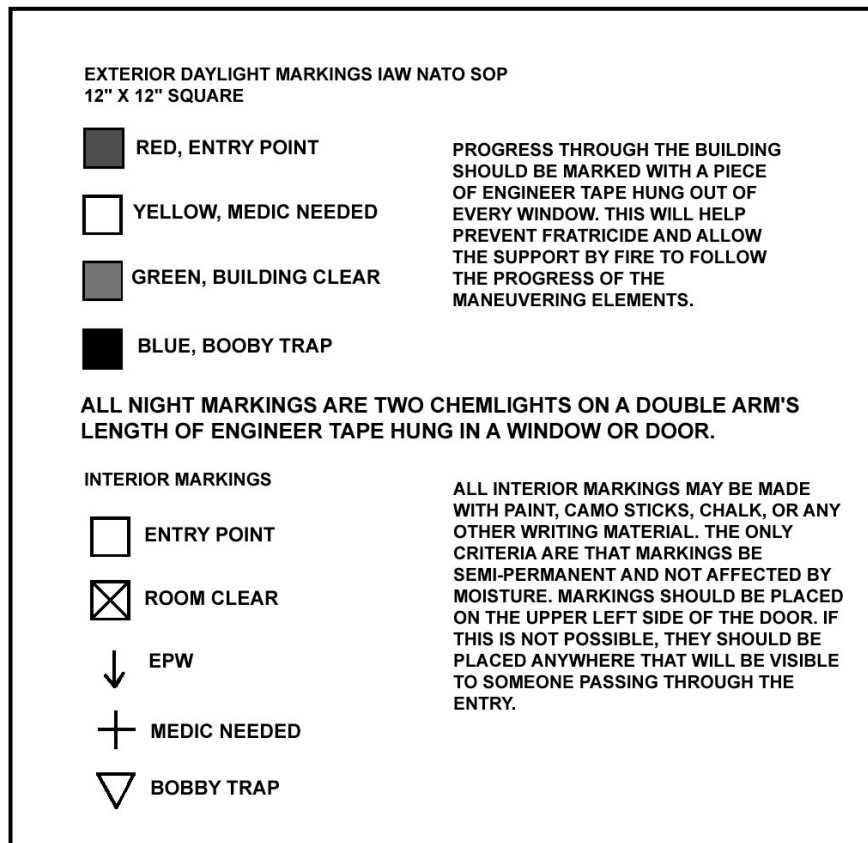

Figure 6-8. Sample marking SOP.

c. **Clearing Techniques.** Methods of movement, firing techniques, weapon positioning, and reflexive shooting are fundamentals used in urban combat. Employing these techniques provides an effective means of achieving success, minimizing noncombatant casualties, and conserving ammunition. Each member of the unit must understand the principles of precision combat and his part in their successful execution.

(1) Special clearing techniques may be required when highly restrictive ROE are in effect. The enemy situation may require that the units clear only a few selected buildings methodically to accomplish their mission rather than using firepower to suppress and neutralize buildings in the objective area. Examples of reasons for a highly restrictive ROE are:

- Use of heavy supporting fires and demolitions would cause unacceptable collateral damage.
- Enemy combatants are so intermixed with noncombatants that the ROE prevents US forces from using all their available supporting fires, and room-by-room clearing may be necessary.

- The likelihood of fratricide requires restrictive ROE.

(2) In a situation where the ROE favor overwhelming firepower, units should employ direct and indirect fires, demolitions, and fragmentation or concussion grenades as necessary to assist in clearing an objective defended by an alert and determined force without noncombatants. (See FM 3-06.11 for more information concerning entering buildings and room clearance techniques.

NOTE: To prevent the possibility of fratricide or injury to friendly inhabitants, leaders should consider the use of stun grenades rather than the fragmentation or concussion grenade.

6-6. CONSOLIDATION AND REORGANIZATION

The squad and platoon will conduct consolidation and reorganization immediately after each action where soldiers are engaged and ammunition is expended. Consolidation is the action taken by the squad or platoon to ensure its security, to prepare for a counterattack by the enemy, and to prepare to continue the mission. Consolidation in an urban environment must be quick in order to repel enemy counterattacks and to prevent the enemy from infiltrating back into cleared buildings or floors. After securing a floor (bottom, middle, or top), selected members of the unit are assigned to cover potential enemy counterattack routes to the building. Priority must be given initially to securing the direction of attack. Security elements alert the unit and place a heavy volume of fire on enemy forces approaching the unit. Reorganization occurs after consolidation. These actions prepare the unit to continue the mission by ensuring key leadership positions are filled and important weapon systems are manned. Many reorganization actions occur simultaneously during the consolidation of the objective.

a. **Consolidation Actions.** Squads assume hasty defensive positions to gain security immediately after the objective has been seized or cleared. Squads that performed missions as assault elements should be prepared to assume an overwatch mission and to support another assault element. Units must guard all avenues of approach leading into their area. These may include:

- Enemy mouseholes between adjacent buildings.
- Covered routes to the building.
- Underground routes into the basement.
- Approaches over adjoining roofs.

b. **Reorganization Actions.** After consolidation, leaders ensure the following actions are taken:

- Resupply and redistribute ammunition.
- Mark buildings to indicate to friendly forces that they have been cleared.
- Treat and evacuate wounded personnel. Once the objective area is secure, begin evacuating noncombatants then enemy wounded.
- Treat and process EPWs.
- Segregate and safeguard noncombatants.
- Reestablish the chain of command.

6-7. CONTINUATION OF THE ASSAULT MISSION

If the unit is going to continue with its original mission, its “be prepared/on order” mission, or receives a new mission, it must accomplish the following tasks:

- The momentum must be maintained. This is a critical factor in clearing operations. The enemy cannot be allowed to move to its next set of prepared positions or to prepare new positions.
- The support element pushes replacements, ammunition, and supplies forward to the assault element.
- Security for cleared areas must be established IAW the OPORD or SOP.
- The support element must displace forward to ensure that it is in place to provide support to the assault element such as isolation of the new objective.

Section II. DEFENSE

In urban areas, buildings provide cover and concealment, limit fields of observation and fire, and block movement of troops, especially mechanized troops. This section covers the key planning considerations, weapons selection, preparations, and the construction of a platoon defensive position on urbanized terrain.

6-8. PLANNING THE DEFENSE

Planning the defense begins when the leader receives a mission or determines a requirement to defend such as during consolidation and reorganization after an assault. The leader must use terrain wisely and designate a point of main effort. He chooses defensive positions that force the enemy to make costly attacks or conduct time-consuming maneuvers to avoid them. A position that the enemy can readily avoid has no defensive value unless the enemy can be induced to attack it. The defense, no less than the offense, should achieve surprise. As platoon leaders conduct their troop-leading procedures, they must consider civilians, ROE, limited collateral damage, and coordination with adjacent units to eliminate the probability of fratricide. Maneuver, methods, and courses of action in establishing defensive positions in and around urbanized terrain are METT-TC intensive.

a. The focus of the squad and platoon for defending in an urban area is the retention of terrain. As with most defensive scenarios, the squad and platoon will defend as part of the company. The platoon will either be given a sector to defend or a battle position to occupy, and the platoon leader must construct his defense within the constraints given to him. In an urban area, the defender must take advantage of the abundant cover and concealment. He must also consider restrictions to the attacker’s ability to maneuver and observe. By using the terrain and fighting from well prepared and mutually supporting positions, a defending force can delay, block, fix, or inflict heavy losses on a much larger attacking force.

b. One of the most common defensive tasks a platoon will be given during urban operations is to conduct a strongpoint defense of a building, part of a building, or a group of small buildings (Figure 6-9). The platoon’s defense is normally integrated into the company’s mission. The platoon leader organizes the strongpoint defense by positioning personnel and their weapons systems to maximize their capabilities. Supporting fires are incorporated into the overall defensive plan to provide depth to the engagement area

(1) The platoon leader organizes the defense into a series of individual, team, and squad fighting positions located to cover avenues of approach and obstacles, and to provide mutual support in order to repel the enemy advance. Snipers should be positioned to support the commander's intent and to allow for the opportunity to engage C2 and key targets.

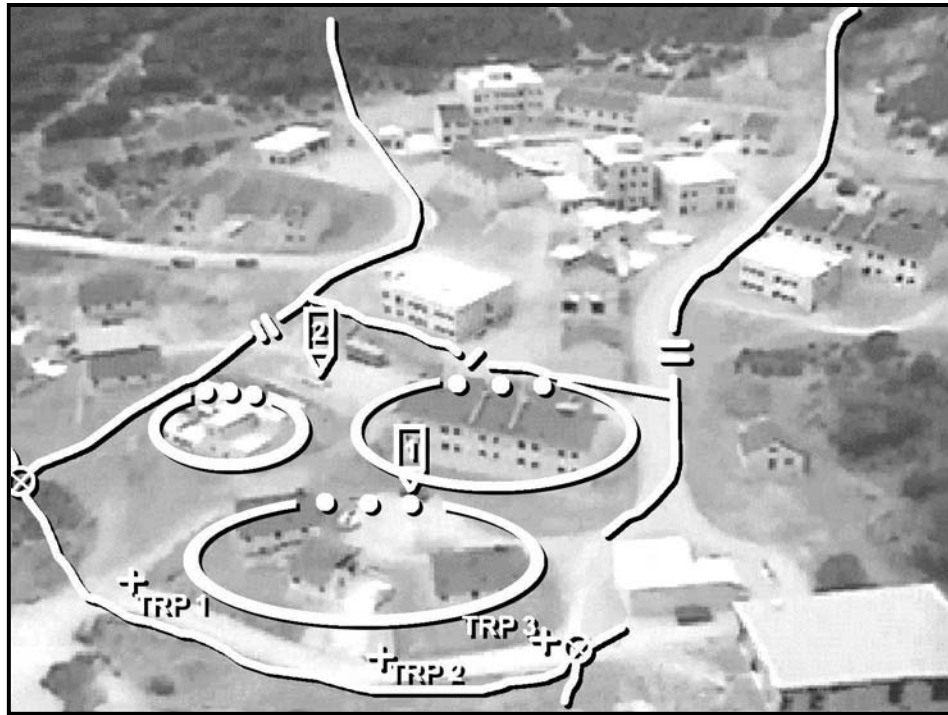

Figure 6-9. Defensive strongpoint.

(2) Position BFVs in covered or concealed locations where they can observe and fire into the engagement area, or use a hide position that they can stay in until the enemy is in the engagement area, then rapidly move into position and kill them.

(3) Depending on the length of the mission, the platoon should stockpile munitions, food and water, medical supplies, and fire fighting equipment.

6-9. HASTY DEFENSE

While operating in an urban area, it is highly possible that the infantry platoon will be called upon to conduct a hasty defensive mission. Unlike the deliberate defense, the hasty defense is characterized by the lack of information about enemy forces and the lack of time to prepare the defense. All of the troop-leading procedures are the same, and many of the priorities of work of the deliberate defense will be the same but may take place concurrently. Units are deployed, BFVs and key weapons emplaced, and fighting positions prepared in accordance with the amount of time available to the unit.

a. **Occupation and Preparation of Positions.** The extent of preparation the platoon is able to accomplish will depend on the amount of time available. Normally, when occupying hasty defensive positions, the platoon takes advantage of the cover and

concealment already present. Given time and materials, the platoon will continue to make improvements to the positions.

(1) In a hasty defense, the platoon first establishes security and positions crew-served weapons. The priorities of improvements may be directed by the priority of work contained in the unit SOP. As a minimum, these improvements should include fields of fire, overhead cover, additional direct fire protection, and camouflaging of individual positions. Fighting positions in buildings are constructed away from windows and other openings in the shadows of the room using appliances, furniture, and other convenient items and materials. Some of the more common hasty fighting positions in an urban area are corners of buildings, behind walls, windows, unprepared loopholes, and the peak of a roof (Figure 6-10).

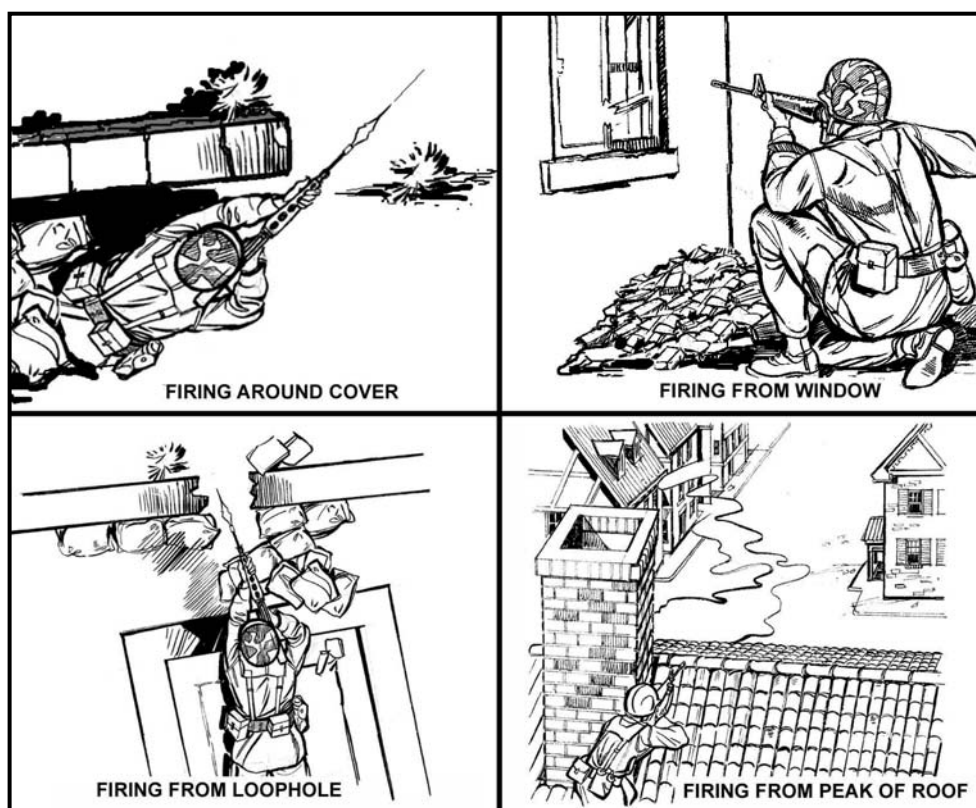

Figure 6-10. Hasty firing positions.

(2) In the urban area, hasty fighting positions for the BFV can be anything from occupying a position in the shadow of a building to a well-covered and concealed position inside a solid structure (Figure 6-11). When positioning the BFV in urban areas, leaders must consider enemy avenues of approach, both mounted and dismounted; key terrain; observation and fields of fire; cover and concealment; fire and explosion hazards; communication restrictions; and withdrawal routes.

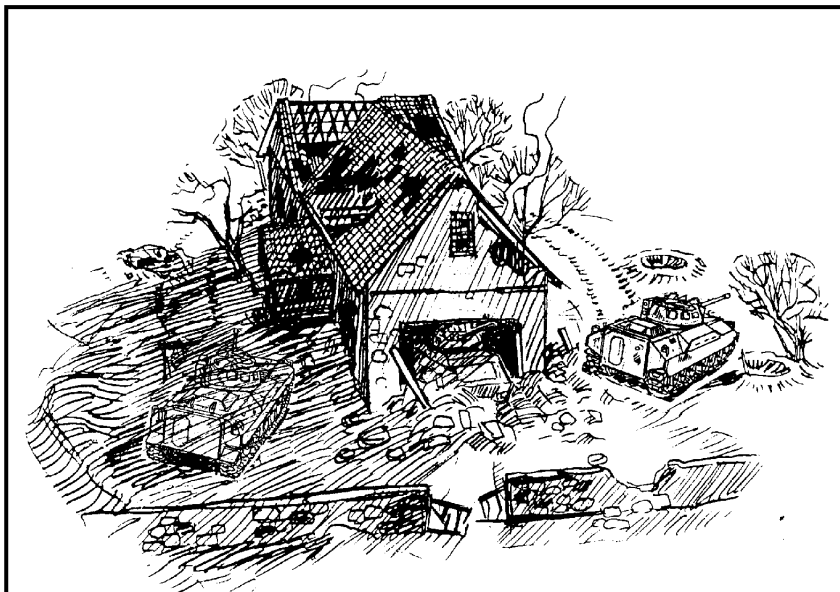

Figure 6-11. Positions in shadows, in buildings, and in the open.

(3) Throughout the defense, the platoon continues to improve its hasty defensive positions. Over time, the hasty defense can become a deliberate defense. The platoon leader and his squad leaders make continuous adjustments to the defense to reduce weaknesses that could result in the failure of the overall defense. The priority of work will serve as the guide for improving the defense, and the leaders will supervise the accomplishment of the following tasks:

- Position BFVs and key weapons.
- Construct barriers and emplace obstacles.
- Prepare individual, alternate, and supplementary fighting positions.
- Rehearse the counterattack force, engagement sequences, and repositioning.
- Enhance mobility.

b. **Improving the Defense.** As time permits, the leaders ensure the following improvements are accomplished:

- Cover and concealment of BFVs and key weapons.
- Barrier and obstacle improvement.
- Improvement of primary and alternate positions.
- Preparation of supplementary positions.
- Additional movement enhancement efforts.
- Initiation of patrols.
- Improvement of camouflage.
- Continued rehearsals for counterattack and withdrawal.
- Sleep plan.

6-10. PRIORITIES OF WORK AND DEFENSIVE CONSIDERATIONS

General defensive considerations in urban terrain are similar to any other defensive operations. Fighting positions in urban areas are usually constructed inside buildings and

are selected based on an analysis of the area in which the building is located, the individual characteristics of the building, and the characteristics of the weapons system.

a. **Priorities of Work.** The general priorities of work in the urban environment should include special attention to the following:

(1) Select key weapons and BFV positions to cover likely mounted and dismounted avenues of approach. To cover armored avenues of approach, position BFVs where flank engagements will occur and position anti-armor weapons inside buildings with adequate space and ventilation for back-blast (on upper floors, if possible, for long-range shots). Position M240Bs and M249s to cover dismounted avenues of approach. Place them near ground level to increase grazing fires. If ground rubble obstructs grazing fires, place MGs/SAWs in the upper stories of the building. Ensure that weapons are mutually supporting and are tied-in with adjacent units.

(2) Ensure the position is free of noncombatants. Remove them from the area of operations before occupation of the position.

(3) Clear fields of fire. Prepare loopholes, aiming stakes, sector stakes, and TRP markings. Construct positions with overhead cover and camouflage (inside and outside).

(4) Identify and secure subterranean avenues of approach (sewers, basements) as well as stairwells and rooftops.

(5) Stockpile ammunition, food, fire-fighting equipment, and drinking water.

(6) Construct barriers and emplace obstacles to deny the enemy access to streets (Figure 6-12), underground passages, and buildings, and to slow his movement. Integrate barriers and or obstacles with key weapons. Cover all barriers and obstacles by fire (both direct and indirect) and or observation. Conceal the obstacles from enemy observation as much as possible. Erect the obstacles in an irregular pattern to hinder enemy movement. Employ the obstacles in depth (if possible). Tie the obstacles in with existing obstacles.

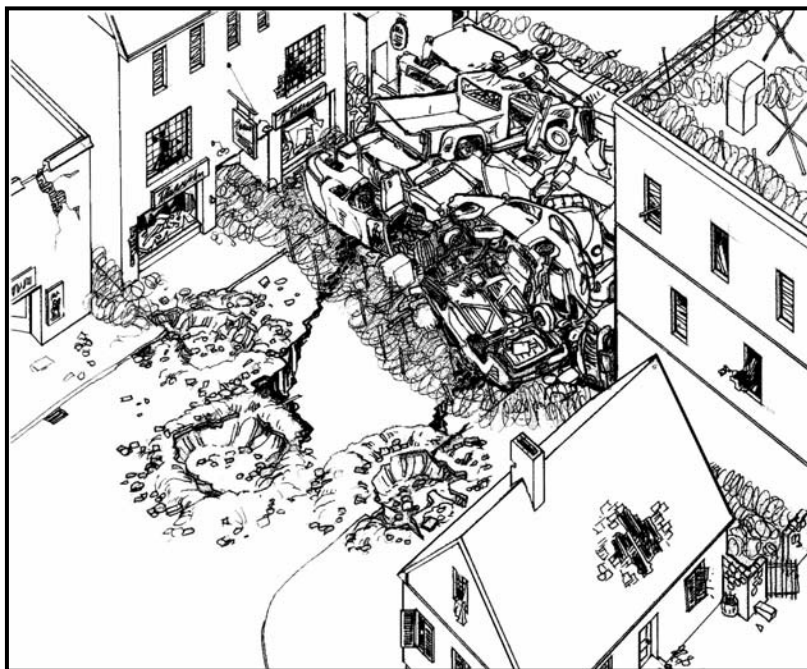

Figure 6-12. Obstacles blocking street.

(7) Improve and mark movement routes between positions as well as to alternate and supplementary positions. Improve routes by digging trenches, using sewers and tunnels, creating mouseholes, and emplacing ropes for climbing and rappelling and ladders for ascent and descent.

b. **Considerations.** The following must be considered when establishing a defensive position.

(1) **Security.** The first priority is to establish all-round security. Each position should have at least one soldier provide security during all preparations.

(2) **Protection.** Select buildings or sites that provide protection from direct and indirect fires. Reinforced concrete buildings with three or more floors provide suitable protection while buildings constructed of wood, paneling, or other light material must be reinforced to provide sufficient protection. One- and two-story buildings without a strongly constructed cellar are vulnerable to indirect fires and require construction of overhead protection for each fighting position. If possible, use materials gathered from the immediate area to build the overhead cover.

(3) **Dispersion.** A platoon position should not be established in a single building when it is possible to occupy two or more buildings that permit mutually supporting fires. A position in one building without mutual support is vulnerable to bypass, isolation, and subsequent destruction from any direction.

(4) **Concealment.** Do not select buildings that are obvious defensive positions (easily targeted by the enemy). If the requirements for security and fields of fire dictate the occupation of exposed buildings, the platoon will be required to add reinforcement materials to the building to provide suitable protection to the troops inside.

(5) **Fields of Fire.** To prevent isolation, individual and crew-served weapons positions should be mutually supporting and have fields of fire in all directions. When clearing fields of fire, try to maintain the natural appearance of the surrounding area if possible. It may be necessary to remove objects that interfere with the gunner's field of vision.

(6) **Covered Routes.** Defensive positions should have at least one covered and concealed route for dismounted infantry that allows resupply, medical evacuation, reinforcement, or withdrawal from the building without being detected. At a minimum it should provide protection from direct fire weapons. The route can be established using underground systems, communications trenches, or walls and buildings that allow covered movement.

(7) **Observation.** Positions in buildings should permit observation of enemy avenues of approach and adjacent defensive sectors. Upper stories offer the best observation but also attract enemy fire.

(8) **Fire Hazard.** If possible, avoid selecting positions in buildings that are obvious fire hazards. If these flammable structures must be occupied, reduce the danger of fire by wetting down the immediate area, laying an inch of sand on the floors, and providing fire extinguishers and fire fighting equipment. Ensure that each defender is familiar with the withdrawal routes and that they have the opportunity to rehearse their withdrawal using these planned routes in the event of fire.

(9) **Time.** Time is the one element in METT-TC that the platoon and its leaders have no control over. The most important factor to consider when planning the use of time is

to provide subordinate leaders with two-thirds of all available time. The unit SOP provides the leaders with their priorities when time does not allow for detailed planning. The platoon will complete defensive preparation IAW the SOP and the commander's operational priorities.

c. **Preparation.** Preparation of the platoon's individual fighting positions will be conducted inside the buildings the platoon has been assigned to defend. As with all defensive positions, the leader's first task is to establish security. This normally will be in the form of an observation post located within the protection of the platoon's direct fire weapons. The OP should be manned with at least two personnel. Leaders then assign individual or two-man positions to adequately cover the sector. The squad leader will position himself to best control his squad. The platoon leader designates the level of security to be maintained. The remaining personnel continue to work preparing the defense. The leaders will continue to make improvements to the defense as time permits. (The preparation of fighting positions is discussed in detail in FM 3-06.11.)

d. **Other Typical Tasks.** Additional defensive preparation tasks may be required in basements, on ground floors, and on upper floors.

(1) **Basements and Ground Floors.** Basements require preparation similar to that of the ground floor. Any underground system not used by the defender that could provide enemy access to the position must be blocked.

(a) *Doors.* Unused doors should be locked or nailed shut as well as blocked and reinforced with furniture, sandbags, or other field expedients.

(b) *Hallways.* If not required for the defender's movement, hallways should be blocked with furniture and tactical wire.

(c) *Stairs.* Unused stairs should be blocked with furniture and tactical wire (Figure 6-13) or removed. If possible, all stairs should be blocked, and ladders should be used to move from floor to floor and then removed.

(d) *Windows.* Remove all glass. Block unused windows with boards or sandbags to prevent observation and access.

(e) *Floors.* Make fighting positions in the floors. If there is no basement, fighting positions can give additional protection from heavy direct-fire weapons.

(f) *Ceilings.* Erect support for ceilings that cannot withstand the weight of rubble from upper floors.

(g) *Unoccupied Rooms.* Block rooms not required for defense with tactical wire.

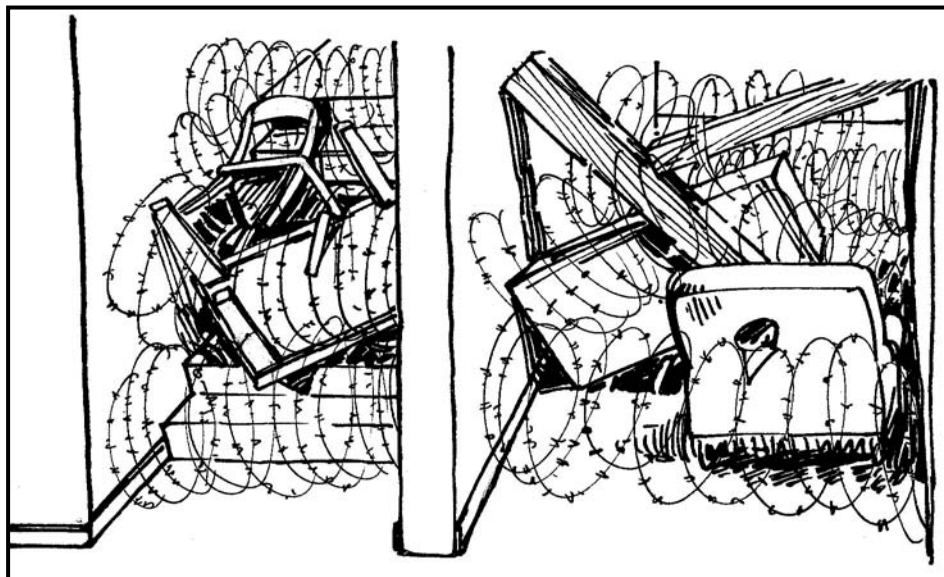

Figure 6-13. Blocking stairs and doorways.

(2) **Upper Floors.** Upper floors require the same preparation as ground floors. Windows need not be blocked, but should be covered with wire mesh, canvas, ponchos, or other heavy material to prevent grenades from being thrown in from the outside. The covering should be loose at the bottom to permit the defender to drop grenades.

(3) **Interior Routes.** Routes are required that permit defending forces to move within the building to engage enemy forces from any direction. Plan and construct escape routes to permit rapid evacuation of a room or a building. Mouseholes should be made through interior walls to permit movement between rooms. Such holes should be marked to enable defenders to easily locate them during both day and night conditions. Brief all personnel as to where the various routes are located and conduct rehearsals so that everyone becomes familiar with the routes.

(4) **Fire Prevention.** Buildings that have wooden floors and rafter ceilings require extensive fire prevention measures. Cover the attic floor and other wooden floors with about one to two inches of sand or dirt, and position buckets of water for immediate use. Place fire-fighting materials (dirt, sand, fire extinguishers, and blankets) on each floor for immediate use. Fill water basins and bathtubs as a reserve for fire fighting. Turn off all electricity and gas. If available, use any existing fire extinguishers found in buildings.

(5) **Communications.** Urban operations require centralized planning and decentralized execution, and communications plays an important part in this process.

(a) Structures and a high concentration of electrical power lines may degrade radio communication in built-up areas and affect a platoon's ability to send and receive digital messages and situational awareness. Many buildings are constructed in such a manner that radio waves will not pass through them.

(b) Visual signals may be used but often are not effective because of the screening effects of buildings and walls. Signals must be planned, widely disseminated, and understood by all assigned and attached units.

(c) Increased noise makes the effective use of sound signals difficult. Verbal signals may communicate the unit's location and intent to the enemy.

(d) Messengers and wire can be used as other means of communication. Wire should be considered an alternate means of communication if assets are available.

(6) **Rubbling.** Rubbling parts of the building may provide additional cover and concealment for weapons emplacements or serve as an obstacle against the enemy. Because of the inherent danger associated with rubbling a building, engineers should perform this task. Units should limit rubbling so as not to impede their own movement within the urban area. If not designated by higher, the platoon must receive permission from higher before rubbling a building within its sector.

(7) **Rooftops.** Platoons must position obstacles on the roofs of flat-topped buildings to prevent helicopters from landing and to deny troops from gaining access to the building from the roof. Cover rooftops that are accessible from adjacent structures with tactical wire or other expedients and guard them. Block entrances to buildings from rooftops if compatible with the overall defensive plan. Remove or block any structure on the outside of a building that could aid the attacker in scaling the building to gain access to upper floors or to the rooftop.

(8) **Obstacles.** Position obstacles adjacent to buildings to stop or delay vehicles and infantry. To save time and resources in preparing the defense, platoon leaders must allow the use of all available materials, such as automobiles, railcars, and rubble, to create obstacles. Vehicles can be tied together by running poles through their windows. Leaders must supervise the construction of obstacles to ensure they are tied to buildings and rubble areas to increase effectiveness and to canalize the enemy into engagement areas selected by the leader. Direct support engineers can provide advice and resources as to the employment of obstacles and mines.

(a) The principles for employing mines and obstacles do not change in the defense of an urban area; however, techniques do change. For example, burying and concealing mines in streets is difficult due to concrete and asphalt. Mines may be placed in sandbags as a technique of camouflage.

(b) Civilian construction equipment and materials must be located and inventoried. This equipment can be used with engineer assets or in place of damaged equipment. In host nation countries, coordination must be made with proper civilian officials before use.

(9) **Fields of Fire.** The field of fire is the area a weapon or group of weapons may cover effectively with fire from a given position. After the defensive positions are selected and the individuals have occupied their assigned positions, they will determine what clearance is necessary to maximize their field of fire. Leaders and individuals must view fields of fire from the fighting position and from the view of the enemy. Only selective clearing will be done to improve the field of fire. If necessary, the position will be relocated to attain the desired field of fire. Within the field of fire, leaders will designate a primary and an alternate sector of fire for each weapons system. Each weapons system has unique requirements for its field of fire, and the platoon and squad leaders must ensure these requirements are met. Each position is checked to ensure that the fields of fire provide the maximum opportunity for target engagement and to determine any dead space within the sector of fire.

e. **Antitank Weapons Positions.** Employ antitank weapons in areas that maximize their capabilities. Position AT weapons in upper stories, and in support of the BFV when

possible (Figure 6-14). The need for protective positioning may require the weapon to be fired from inside of a building, from behind the cover of a building, or from behind the cover of protective terrain. Leaders should make every effort to employ antitank weapons in pairs so that the same target can be engaged from different positions. Another consideration is security for the crew and system. This is necessary to allow the gunner to concentrate on locating and engaging enemy armor.



Figure 6-14. Javelin position supporting BFV.

f. **Sniper Positions.** Snipers give the platoon a force multiplier by providing an overwatch capability and by engaging enemy C2 targets. Snipers normally operate in two-man teams, which provides the shooter with security and another set of eyes for observation and to locate and identify targets. Leaders should allow the snipers to select their own positions for supporting the defense. Snipers deploy in positions where they are not easily detected (Figure 6-15), and where they can provide the most benefit. (See FM 23-10 and FM 3-06.11 for more information on the employment of snipers.)

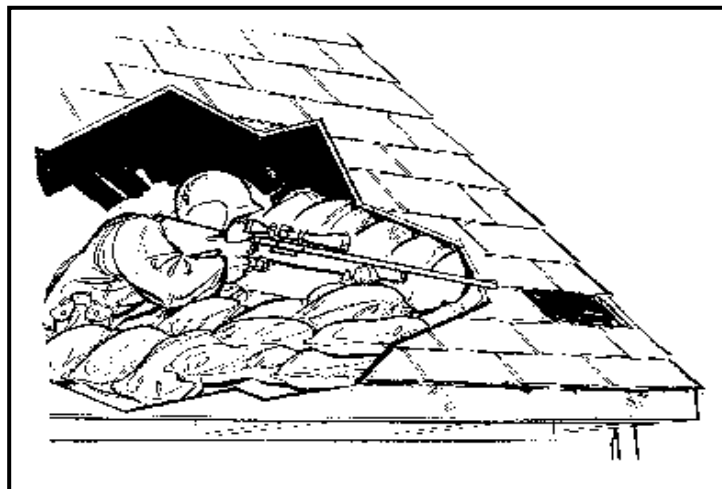

Figure 6-15. Sniper position (cut away).

6-11. CONDUCT OF THE DEFENSE

The conduct of the defense in an urban area is similar to the conduct of the defense in any other area. The current standard sequence of actions is listed in Chapter 5 of this manual.

6-12. CONSOLIDATION AND REORGANIZATION

The process of consolidation and reorganization in an urban area is similar to the process in any other area. The current standard sequence of actions is listed in Chapter 4 of this manual.

6-13. COUNTERATTACK

A platoon may be given the mission to counterattack in order to retake a defensive position or key point, to destroy or eject an enemy foothold, or to stop an enemy attack by hitting his flank and forcing him to stop his movement and establish a hasty defense.

a. A platoon counterattack is planned at company level to meet each probable enemy penetration. They must be well coordinated and violently executed. Counterattacks should be directed at the enemy's flank and supported with direct and indirect fires.

b. If tank support is available, it should be used in conjunction with the BFVs to spearhead the counterattack. Tanks have the mobility, firepower, and survivability to quickly execute the counterattack mission. They are ideally suited for destroying enemy armor, heavy weapons, and fortifications with their main gun and engaging enemy infantry with their coaxial machine gun. This capability will assist the infantry in executing its part of the mission.

c. The counterattack mission is planned and coordinated as part of the defensive operation.

(1) Considerations for counterattack planning may include, but are not limited to, the following:

- Location of friendly units.
- Location of noncombatants.
- Critical location in the defense that, if threatened, could collapse.
- Where in the defense do we want the enemy to think he is successful?
- Size and type of force required to defeat and eject the enemy.
- Who determines and initiates the execution of the counterattack?

(2) Control measures needed for the conduct of the counterattack include:

- Assembly area or blocking position.
- Start point, route, and release point, if necessary.
- Attack position.
- Line of departure or line of contact.
- Zone of action, direction of attack, and or axis of advance.
- Objective.
- Limit of advance.

Section III. COMBAT MULTIPLIERS

An important lesson learned from recent urban operations (UO) is the need for a fully integrated combined arms team. The nature of UO makes it infantry-centric. However,

the urban battle should never be exclusively an infantry fight. A powerful combined-arms team properly employed in an urban area will enhance mission accomplishment. Although the infantry soldier is required in order to clear and secure an urban area, the integration of armor and engineers is needed for increased lethality. Fully integrated aviation, field artillery, communications, and logistical elements must provide support for these teams. This section discusses the more common combat multipliers available to the infantry platoon during the execution of UO.

6-14. ARMORED VEHICLES

Based on the considerations of the METT-TC analysis and the operational ROE, a situation may arise that requires the attachment of tanks in direct support of the mechanized infantry mission. This paragraph discusses tactics and techniques used by infantry units when working with armored vehicles.

a. Task Organization for Tank/Mechanized Operations.

(1) **Maneuver.** Leaders must understand the principles of employing infantry and armor forces to maximize their capabilities and ensure mutual support. Maneuver by the infantry is enhanced by support from the armored vehicles.

(a) The infantry assists the heavy forces by infiltrating to clear obstacles or key enemy positions and to disrupt the enemy defense. They provide security for the armored vehicles by detecting and suppressing or destroying enemy antitank weapons. They designate targets and spot the impact of fires for tanks and BFVs.

(b) Heavy forces support the infantry by moving with them along an axis of advance and providing a protected, fast moving assault weapons system. They suppress and destroy enemy weapons, bunkers, and tanks by fire and maneuver (Figure 6-16). They also provide transport when the enemy situation permits.

(c) Armored vehicles should never be maneuvered individually. The smallest maneuver level for armor is a section (two vehicles).

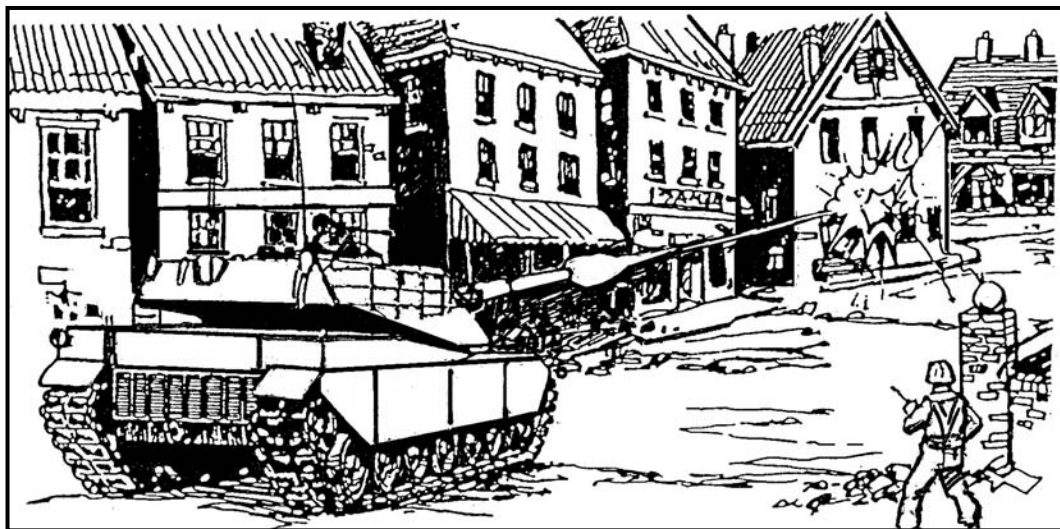

Figure 6-16. Tank in direct support of infantry.

(2) **Command and Control.** The infantry platoon may have combat elements in direct support. The platoon leader is responsible for incorporating these elements into his C2 functions. Because most support elements have a habitual relationship with the combat unit they support, the platoon leader may only need to give them an update to recent changes to guarantee that C2 remains a high priority.

(a) Tanks and mechanized infantry must work closely at platoon level. In most operations where they work together, infantrymen must establish direct communication with individual vehicles to ensure quick and accurate response to directions given.

(b) Infantrymen and vehicle crews must know how to communicate by radio, telephone, and visual signals. Prior to the start of an operation, infantry and tank leaders must coordinate the methods of communication and the types of signals that will be used. For immediate, direct communication with the M1A1/A2, the crew can run communication wire from the vehicle intercom system kit (AN/VIC or AN/VS3) through the loader's hatch or vision block and be connected to a field phone attached to the outside of the tank.

(c) During the planning phase of an operation, infantry and armor leaders must allocate sufficient time for the conduct of detailed brief-backs and rehearsals. The purpose of these activities is to verify that long- and short-range communications are effective, and that what is expected from each organization is understood.

NOTE: For further discussion concerning the strengths, limitations, and employment considerations of armor with the infantry, see FM 3-06.11.

b. **Weapon System Considerations.** While operating in concert with armored forces, the infantry leader must be knowledgeable of the capabilities, limitations, and effects of the armor weapon systems. He must understand the dangers these systems pose to his soldiers when operating together and ensure that his soldiers are briefed about these dangers. Figure 6-17 shows the difference in the capabilities of the BFV and the M1A1/A2 tank with regard to fields of fire on urban terrain. Note that the BFV can engage a target 9 to 10 stories high at 20 meters, whereas an M1A1/A2 tank requires 90 meters.

(1) **Bradley Fighting Vehicles.**

(a) The primary role of the BFV in an urban environment is to provide suppressive fires and to breach exterior walls. The vehicle's armor-piercing rounds can be very useful in urban terrain. It can penetrate concrete up to 16 inches thick and can easily penetrate brick structures. It is highly effective against earthen- and sandbag-reinforced structures.

(b) The BFV can elevate its 25-mm gun to about +60 degrees and depress the gun to about -10 degrees.

(c) The crew has limited visibility to the sides and rear and no visibility to the top when buttoned up.

(d) The BFV can be outfitted with an external phone hookup for communications with accompanying infantry.

(e) The 25-mm gun can be used effectively against enemy-occupied buildings and fortifications, firing AP, HE, and even TP-T rounds.

(2) *M1-Series Tanks.*

(a) Normally, the primary ammunition for the main gun in the urban environment is the HEAT round. It is the most effective round against masonry and will penetrate all but the thickest reinforced concrete. A HEAT round will create a hole in masonry or concrete large enough for a man to fit through but will not cut the reinforcing steel bars. HEAT is also effective against earthen- and sandbag-reinforced strong points. A 120-mm HEAT round does not become armed until it is about 36 feet from the end of the gun tube.

(b) Multipurpose antitank (MPAT) rounds will penetrate masonry and concrete but are less effective than HEAT rounds against heavier structures.

(c) Sabot ammunition has limited use against nonvehicular targets, and its discarding petals endanger accompanying infantry. Sabot petals create a hazard area extending 70 meters on either side of the gun target line for a distance of one kilometer.

(d) The external M2 HB (cal. 50) machine gun can elevate to +36 degrees; however, to fire the cal. 50 on the M1A2 Abrams, the tank commander must be exposed to enemy fire.

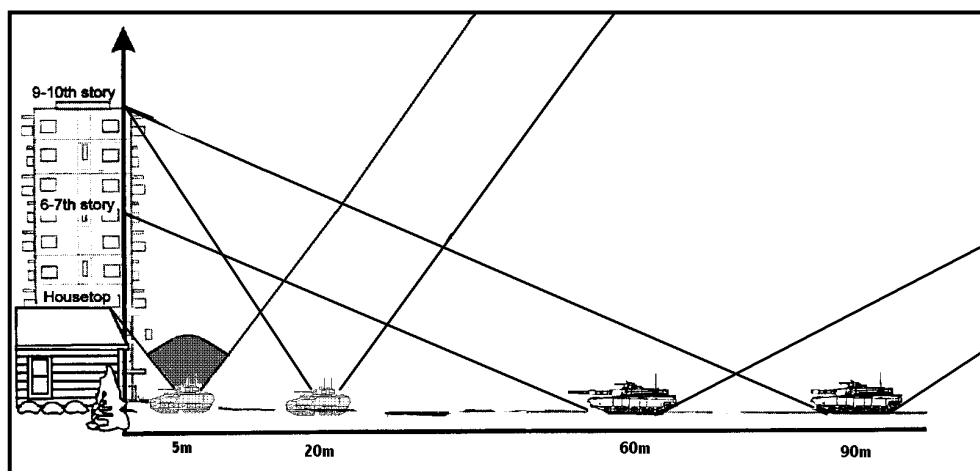

Figure 6-17. Fields of fire on urban terrain.

NOTE: When employing these weapon systems to support the infantry assault, leaders must be aware of the explosive effects and fragmentation fallout, as well as the blast over pressure, and how it will affect the infantry on the ground. (For more specific information on the effects of weapons, see FM 3-06.11.)

6-15. ENGINEERS

Normally an engineer squad will be attached to an infantry company. Most engineer manual-labor tasks (for example, preparing fighting positions) will have to be completed by infantry units, with reinforcing engineer heavy-equipment support and technical supervision. (For further discussion on the employment of engineers with the infantry, see FM 3-06.11.)

a. **Offensive Missions** During offensive operations, an engineer sapper team may be attached to the infantry platoon that is designated as the primary assault element. They may be required to conduct the following tasks in support of the infantry platoon:

- Use explosives to destroy fortifications and strong points that cannot be reduced with the maneuver unit's organic assets.
- Locate and remove mines that may hamper the unit's movement.
- Conduct breaching operations.

b. **Defensive Missions.** Engineers may perform the following tasks in support of the platoon during the defense of an urban area:

- Construct complex obstacle systems.
- Assist in the preparation of defensive positions and strong points.

NOTE: When employing demolitions along side the infantry assault, leaders must be aware of the explosive effects and fragmentation fallout, as well as the blast over pressure, and how it will affect the infantry on the ground. (For more specific information on the effects of weapons, see FM 3-06.11.)

6-16. MORTARS

Mortars are the most responsive indirect fires available at battalion and below. Their mission is to provide close and immediate fire support to maneuver units. Mortars are well suited for combat in urban areas because of their high rate of fire, steep angle of fall, and short minimum range. Leaders must plan mortar support with the FSO as part of the total fire support system. (See FM 7-90 for detailed information on the tactical employment of mortars.)

a. **Role of Mortar Units.** The primary role of mortar units is to deliver suppressive fires to support maneuver, especially against dismounted infantry. Mortars can also be used to obscure enemy observation and to illuminate the target area at night. Mortar fires inhibit enemy fires and movement, allowing friendly forces to maneuver to a position of advantage. Effectively integrating mortar fires with dismounted maneuver is key to successful combat in an urban area at the rifle company and battalion level.

b. **Position Selection.** The selection of mortar positions depends on the size of buildings, the size of the urban area, and the mission.

(1) The use of existing structures (for example, garages, office buildings or highway overpasses) for hide positions is recommended to afford maximum protection and minimize the camouflage effort.

(2) Mortars should not be mounted directly on concrete; however, sandbags may be used as a buffer. Sandbags should consist of two or three layers, be butted against a curb or wall, and extend at least one sandbag width beyond the baseplate.

(3) Mortars are usually not placed on top of buildings because lack of cover makes them vulnerable. Overpressure can injure personnel, and the shock on the floor can weaken or collapse the structure. Mortars should not be placed inside buildings with damaged roofs unless the structure's stability has been checked.

c. **High-Explosive Ammunition.** During urban combat, mortar HE fire is used more than any other type of indirect fire weapon. The most common and valuable use of mortars is for harassment and interdiction fires. One of their greatest contributions is interdicting supplies, evacuation efforts, and reinforcement in the enemy rear just behind his forward defensive positions. Although mortar fires are often targeted against roads and other open areas, the natural dispersion of indirect fires will result in many hits on

buildings. Leaders must use care when planning mortar fires during urban combat to minimize collateral damage.

(1) High-explosive ammunition, especially the 120-mm projectile, provides good results when used on lightly built structures within cities. It does not perform well against reinforced concrete found in larger urban areas.

(2) When using HE ammunition in urban fighting, only point-detonating fuzes should be used. The use of proximity fuzes should be avoided because the nature of urban areas causes proximity fuzes to function prematurely. Proximity fuzes, however, are useful in attacking targets such as OPs on tops of buildings.

(3) During World War II and recent Middle East conflicts, light mortar HE fires have been used extensively during urban combat to deny the use of streets, parks, and plazas to enemy personnel.

d. **Illumination.** In the offense, illuminating rounds are planned to burst above the objective to put enemy troops in the light. If the illumination is behind the objective, the enemy troops would be in the shadows rather than in the light. In the defense, illumination is planned to burst behind friendly troops to put them in the shadows and place the enemy troops in the light. Buildings reduce the effectiveness of the illumination by creating shadows. Continuous illumination requires close coordination between the FO and FDC to produce the proper effect by bringing the illumination over the defensive positions as the enemy troops approach the buildings.

e. **Special Considerations.** When planning the use of mortars, leaders must consider the following:

(1) Forward observers should be positioned in the upper levels of buildings so target acquisition and adjustments in fire can be accomplished effectively.

(2) Leaders must understand ammunition effects correctly to estimate the number of volleys needed for specific target coverage. The effects of using WP or RP may create unwanted smoke screens or limited visibility conditions that could interfere with the tactical plan.

(3) Forward observers must be able to determine dead space. Dead space is the area in which indirect fires cannot reach the street level because of buildings. This area is a safe haven for the enemy. For mortars, the dead space is about one-half the height of the building.

(4) Mortar crews should plan to provide their own security.

(5) Commanders must give special consideration to where and when mortars are to displace while providing immediate indirect fires to support the overall tactical plan. Combat in urban areas adversely affects the ability of mortars to displace because of rubble and the close nature of urban combat.

6-17. FIELD ARTILLERY

During urban combat, field artillery (FA) provides direct support, general support, and general support reinforcing to infantry units. This paragraph provides considerations for the use of field artillery in the direct-fire mode. (For further discussion on the employment of field artillery in urban terrain, see FM 3-06.11.)

a. When FA supports fighting in urban areas, fire support coordination measures necessary to provide adequate yet safe support must be carefully considered due to the

close proximity of friendly forces to the enemy. When planning for fire support, leaders should consider the following:

- The increased cover and concealment afforded by the terrain.
- Ground observation is limited in urban areas.
- Adjusting fires is difficult since buildings block the view of adjusting rounds.
- Acquiring targets is difficult in urban terrain because the enemy has many covered and concealed positions and movement lanes.
- Forward observers must be able to determine where and how large the dead spaces are.
- The use of air burst fires is an effective means of clearing snipers from rooftops.

b. Employing artillery in the direct-fire mode to destroy fortifications should be considered, especially when assaulting well-prepared enemy positions. Also, restrictive fire support coordination measures, such as a “restrictive fire area” or “no-fire area,” may be imposed to protect civilians and critical installations.

(1) 155-mm self-propelled howitzer is extremely effective in neutralizing concrete targets with direct fire.

(2) Concrete-piercing 155-mm rounds can penetrate 36 inches of concrete at ranges up to 2,200 meters.

(3) When employing artillery in the direct-fire mode and maneuvering the self-propelled howitzers within the urban area, it is important that the infantry secure them because they do not have any significant protection for their crews.

NOTE: When employing these weapon systems to support the infantry assault, leaders must be aware of the explosive effects and fragmentation fallout, as well as the blast over pressure, and how it will affect the infantry on the ground. (For more specific information on the effects of weapons, see FM 3-06.11.)

6-18. ATTACK HELICOPTERS

Infantry units may receive support by a variety of attack helicopters, including (but not limited to) the AH-64A, AH-64D, OH-58D, and MH-6. Attack helicopters can provide area fire to suppress targets and precision fire to destroy specific targets or breach structures. Attack helicopters provide real-time reconnaissance information through direct viewing of the area of operations. This facilitates the platoon leader’s ability to effectively coordinate and integrate all aspects of the mission. Attack helicopters can also assist with ISR CAS integration and communications using their advanced suite of sensors and radios. Other supporting helicopters, such as the UH-60, CH-47 and MH-47 may also have weapons systems (7.62-mm machine gun, cal. 50 machine gun, 7.62-mm mini-gun) that aid in the suppression of enemy forces when operating in urban terrain. Operational control of attack helicopter units will remain at the level of battalion or higher; however, attack helicopters may conduct direct air-to-ground coordination with companies and platoons during combat operations. (For further discussion on the supporting role of the attack helicopter, see FM 1-114 and FM 3-06.11.)

6-19. ANTIARMOR WEAPONS

The tactical use of antiarmor weapons does not change in the urban environment but how they are employed does. Some of those employment limitations are: stand-off, displacement after engagements, the ability to fire in-depth engagements, more obstacles, increased danger zones, and all-round security. (For further discussion on the employment of antiarmor weapons in the urban environment, see and FM 3-06.11.)

a. Although antiarmor weapons are primarily designed to destroy armored vehicles, they can also be used to damage or destroy fortifications. Additionally, they can be used for ballistic breaching of doorways and the walls of lightly constructed buildings to create entry points. They may also be used for creating deceptions just before the assault element enters the actual initial breach (entry) point. The larger systems (TOW and Dragon) that have highly magnified day and thermal sights can be used to detect snipers and to disrupt or kill them with long-range missiles.

b. Engaging targets from an enclosure creates unique hazards. Before positioning soldiers in enclosures (combat only), leaders must consider several factors that affect safety. Only in combat, and when no other tactical option exists, should antiarmor weapons be fired from an enclosure. If antiarmor weapons must be employed this way, the enclosure must meet the following minimum requirements.

- Construction of wood or stucco buildings must be sturdy to reduce the damage that will occur.
- All objects and debris must be removed from the rear of the weapon because the backblast will cause loose objects to fly around the enclosure, possibly injuring someone.

NOTE: When employing these weapon systems to support the infantry assault, leaders must be aware of the explosive effects and fragmentation fallout, as well as the blast over pressure, and how it will affect the infantry on the ground. (For more specific information on the effects of weapons, see FM 3-06.11.)

6-20. SNIPERS

The company sniper team is an important and effective combat multiplier. While conducting offensive operations in urban areas, the sniper can be used as part of the support element to provide accurate, long-range fires. They can also be an invaluable source of information with their observation capability. The sniper team is a company asset and may be attached to a platoon in order to conduct a mission-specific task. However, it is unlikely that the platoon would be given tactical control of a sniper team. (For further discussion on the employment of snipers, see and FM 3-06.11.)

CHAPTER 7

TACTICAL ENABLING OPERATIONS

Tactical enabling operations are specialized missions planned and conducted to achieve or sustain a tactical advantage and executed as part of an offensive, defensive, stability, or support operation. At the platoon level, these include reconnaissance, retrograde (withdrawal and delay), special purpose operations (linkup, stay-behind, relief in place, and passage of lines), and security. The BFV infantry platoon and rifle squads typically conduct these operations as part of a larger force.

7-1. RECONNAISSANCE

Reconnaissance is any mission undertaken to obtain, by visual observation or other detection methods, information about the activities and resources of an enemy or potential enemy, or to secure data concerning the physical characteristics of a particular area. Successful reconnaissance is a focused effort aimed at gathering timely, accurate information about the enemy and the terrain in the area of operations. It is the responsibility of every leader to conduct reconnaissance to gain the information he needs to ensure the success of his mission. In addition, the platoon may conduct other reconnaissance operations to gather information as part of a higher headquarters' intelligence, surveillance, and reconnaissance (ISR) operations. (For a more detailed discussion of reconnaissance or ISR operations, refer to FM 7-92, FM 17-95, or FM 3-90.)

a. **Reconnaissance Planning.** Before an operation, the company commander determines what he must know about the enemy. He must first request the information needed from the next higher headquarters. If they cannot provide or gather the information needed, they will authorize the commander to send a reconnaissance element forward (METT-TC dependent). As an example of identifying information requirements before an operation, the company team commander determines he must find out if an enemy force is controlling a choke point through which the team must move during the next day's attack. The commander may decide to send a platoon's rifle squads to reconnoiter the choke point the night before the attack. Once the operation is under way, the commander continues to identify information requirements. An example is the need to find an assailable flank or other position of advantage over an identified enemy force while the company team develops the situation. In such a situation, the commander may dispatch a platoon or section to find a flank or position from which the team can effectively engage the enemy.

b. **Reconnaissance Execution.** Reconnaissance can be passive or active. Passive reconnaissance includes such techniques as map and photographic reconnaissance and surveillance. Active methods include mounted and dismounted ground reconnaissance and reconnaissance by fire. Active reconnaissance operations are also classified as aggressive or stealthy.

(1) Aggressive reconnaissance is characterized by the speed and manner in which the reconnaissance element develops the situation once contact is made with an enemy force.

A unit conducting aggressive reconnaissance uses both direct and indirect fires and movement to develop the situation. It uses primarily mounted reconnaissance and reconnaissance by fire. In conducting a mounted patrol, the unit employs the principles of tactical movement to maintain security. The patrolling element uses cover and concealment and conducts bounding overwatch as necessary to avoid detection. (For a more detailed discussion of tactical movement, refer to Chapter 3 of this manual.)

(2) Stealthy reconnaissance emphasizes techniques and procedures that allow the unit to avoid detection and engagement by the enemy. It is more time-consuming than aggressive reconnaissance. To be effective, stealthy reconnaissance relies primarily on rifle squads making maximum use of covered and concealed terrain. The company team's primary assets for stealthy reconnaissance are its infantry squads.

c. **Reconnaissance Before and After Operations.** To be most effective, reconnaissance must be conducted continuously before, during, and after operations. Before an operation, the company team focuses its reconnaissance effort on filling gaps in its information about the enemy and the terrain. After an operation, the team conducts reconnaissance to maintain contact with the enemy and collect information for upcoming operations. Situations in which the platoon may conduct reconnaissance before or after an operation include the following:

- Reconnaissance by a quartering party of an assembly area and the associated route to it.
- Reconnaissance by platoons from the assembly area to and in the vicinity of the LD before an offensive operation.
- Reconnaissance by rifle squads to probe enemy positions for gaps open to an attack or infiltration.
- Reconnaissance by rifle squads to observe forward positions and guide mounted elements to key positions on the battlefield.
- Reconnaissance by rifle squads (normally with engineers) to locate bypasses around obstacle belts or to determine the best locations and methods for breaching operations.
- Reconnaissance by rifle squads of chokepoints or other danger areas in advance of the remainder of the company team.
- Reconnaissance by mounted patrols to observe forward positions or to clear a route to a forward position.
- Reconnaissance by platoons of defensive positions or engagement areas for conducting the defense.
- Reconnaissance by mounted or dismounted rifle squads as part of security operations to secure friendly obstacles, clear possible enemy OPs, or cover areas not observable by stationary OPs.
- Reconnaissance by sections or rifle squads to maintain contact with adjacent units.
- Reconnaissance by sections or dismounted rifle squads to maintain contact with enemy elements.

d. **Reconnaissance During Operations.** During offensive operations, platoon reconnaissance normally focuses on fighting for information about the enemy and the terrain, with the primary goal of gaining an advantage over the enemy. The platoon conducts this type of reconnaissance during actions on contact. As the platoon develops

the situation, the platoon leader may dispatch mounted or dismounted patrols to identify positions of advantage or to acquire an enemy force. The information gained by the platoon in contact is critical to the success of its own mission and to the success of its higher headquarters.

e. **Forms of Reconnaissance.** In addition to reconnaissance performed as part of another type operation, there are four forms of reconnaissance conducted as distinct operations: route reconnaissance, zone reconnaissance, area reconnaissance, and reconnaissance in force. Although not optimally organized for reconnaissance, the company team can direct a BFV-equipped platoon to conduct route, zone, or area reconnaissance. (Reconnaissance in force is a limited-objective operation conducted by battalion-size and larger forces.)

The platoon may conduct a reconnaissance operation during preparation for another operation of its own (for example, performing zone reconnaissance before initiating a stationary guard operation), or it can conduct the reconnaissance to gain information for a higher headquarters.

In conducting a route, zone, or area reconnaissance, the platoon employs a combination of mounted and dismounted elements and reconnaissance by direct and indirect fires. Based on his evaluation of the factors of METT-TC, the commander establishes the role of assigned elements and support assets in his scheme of maneuver. Mechanized infantry platoons normally perform the reconnaissance role, taking advantage of their ability to use rifle squads to gather information on the ground.

In planning for route, zone, or area reconnaissance, the platoon leader receives the focus of the mission from the commander. The commander identifies whether the reconnaissance will be oriented on the terrain or on the enemy force. In a force-oriented reconnaissance operation, the critical task will be to find the enemy and to gather information about him. Terrain considerations of the route, zone, or area are only a secondary concern. The platoon generally is able to move more quickly in force-oriented reconnaissance than in terrain-oriented reconnaissance. The following paragraphs examine the specifics of route, zone, and area reconnaissance.

(1) **Route Reconnaissance.** A route reconnaissance is a directed effort to obtain detailed information on a specific route as well as on all terrain from which the enemy could influence movement along that route. Route reconnaissance may be oriented on a specific area of movement, such as a road or trail, or on a more general area, such as an axis of advance. It is normally assigned when a commander wants to use the route in question. Although METT-TC and the commander's intent will dictate what actions the platoon takes, the following tasks are normally considered critical components of a reconnaissance:

- Determine the trafficability of the route.
- Reconnoiter all built-up areas. Locate a bypass around built-up areas.
- Reconnoiter all terrain the enemy can use to dominate movement along the route.
- Reconnoiter all lateral routes (within capability).
- Inspect and evaluate all bridges (within capability).
- Locate fords and crossing sites near all bridges.
- Locate a bypass around contaminated areas.

- Reconnoiter all defiles. This task includes clearing defiles of enemy forces and obstacles (within capability) or locating bypasses.
- Locate and clear mines, obstacles, and barriers (within capability). Locate a bypass around obstacles.
- Find and report all enemy elements that can influence movement along the route.
- Report all reconnaissance information.

(2) **Zone Reconnaissance.** A zone reconnaissance is a directed effort to obtain detailed information concerning all routes, terrain, enemy forces, and obstacles (including areas of contamination) within a zone defined by specific boundaries. The zone reconnaissance is normally conducted when the enemy situation is vague or when information concerning cross-country trafficability is required. As in route reconnaissance, the commander's intent and the factors of METT-TC will dictate the platoon's actions. The following tasks are normally considered critical components:

- Find and report all enemy forces in zone.
- Reconnoiter specific terrain in zone.
- Report all reconnaissance information.

If time permits, the commander may also direct the platoon to accomplish the following route reconnaissance tasks as part of a zone reconnaissance:

- Reconnoiter all terrain within the zone.
- Inspect and classify all bridges, overpasses, underpasses, and culverts (within capability).
- Locate fords or crossing sites near all bridges.
- Locate and clear all mines, obstacles, and barriers (within capability).
- Locate bypasses around built-up areas, obstacles, and contaminated areas.

(3) **Area Reconnaissance.** Area reconnaissance is a specialized form of zone reconnaissance. It is a directed effort to obtain detailed information concerning the terrain or enemy activity within a prescribed area. The area can be any location critical to the unit's operations. Examples include easily identifiable areas covering a fairly large space (such as towns or military installations), terrain features (such as ridge lines, wood lines, choke points), or a single point (such as a bridge or a building). The critical tasks of the area reconnaissance are the same as those associated with zone reconnaissance.

7-2. LINKUP OPERATIONS

Linkup entails the meeting of friendly ground forces (or their leaders or designated representatives). It may occur in, but is not limited to, the following situations:

- Advancing forces reaching an objective area previously secured by air assault, airborne, or infiltrating forces.
- Units conducting coordination for a relief in place.
- Cross-attached units moving to join their new organization.
- Advancing forces during follow and support mission.
- A unit moving to assist an encircled force.
- Units converging on the same objective during the attack.
- Units conducting a passage of lines.
- Units conducting reconnaissance forward of the main body.

a. **Steps of the Linkup Operation.** The platoon conducts linkup operations independently or as part of a larger force. The platoon may lead the linkup force. The linkup consists of three steps:

(1) **Far Recognition Signal.** The units or elements involved in the linkup establish communications before they reach direct fire range. The lead element of each linkup force monitors the radio frequency of the other friendly force. FBCB2-equipped units may also achieve far recognition through displayed icons and digital messages.

(2) **Coordination.** Before initiating movement to the linkup point, the forces must coordinate necessary tactical information including the following:

- The known enemy situation.
- Type and number of friendly vehicles.
- Disposition of stationary forces (if either unit is stationary).
- Routes to the linkup point and rally point (if used).
- Fire control measures.
- Near recognition signal(s).
- Communications information.
- CS coverage.
- CSS responsibilities and procedures.
- Finalized location of the linkup point and rally point (if used).
- Special coordination requirements such as maneuver instructions or requests for medical support.
- Visual linkup signals or alternate locations for linkup due to contact.

(3) **Movement to the Linkup Point and Linkup.** All units or elements involved in the linkup must enforce strict fire control measures to help prevent fratricide. Linkup points and restrictive fire lines must be recognizable by moving and or converging forces. Linkup elements take these actions:

- Conduct far recognition using FM radio (and digital, if FBCB2-equipped).
- Conduct short-range (near) recognition using the designated signal.
- Complete movement to the linkup point.
- Establish local security at the linkup point.
- Conduct additional coordination and linkup activities as necessary.

b. **Planning Considerations.** When planning a linkup, the platoon leader follows standard troop-leading procedures.

(1) The BFV's equipment (ISU or IBAS) allows for an improved operational picture between elements conducting the linkup operation to aid in navigation and to prevent fratricide. As the moving force closes on the linkup site, the stationary force is aware of its location thus reducing the possibility of fratricide. The moving unit does the same to reduce fratricide potential.

(2) Once the moving unit arrives close to the linkup location, the stationary unit should challenge it. For example, the stationary unit can give the moving unit a series of flashes using an infrared source during limited visibility. The moving force responds with a pre-coordinated number of flashes.

(3) The challenge and password may also be accomplished with audible sounds or digitally (if FBCB2-equipped).

(4) Infrared and thermal equipment enhances linkups conducted during limited visibility. Infrared lights aid in the linkup and as recognition signals. For example, the unit manning the linkup point can string infrared lights high in a tree or on a piece of distinguishable terrain to help guide the moving unit to the linkup site. This is particularly advantageous when the moving unit has difficulty finding the linkup site due to bad weather or restrictive terrain. Both units must know the capabilities of the enemy, and they must exercise caution when using infrared devices against an enemy with night vision capability.

7-3. PASSAGE OF LINES

A passage of lines entails movement of one or more units through another unit. This operation becomes necessary when the moving unit(s) cannot bypass the stationary unit and must pass through it. The primary purpose of the passage is to maintain the momentum of the moving elements. A passage of lines may be designated as either forward or rearward.

The controlling company team is responsible for planning and coordination of a passage of lines involving the platoon. In some situations, as when the platoon is using multiple passage routes (such as a separate route for each squad or section), the platoon leader must take responsibility for planning and coordinating each phase of the operation.

a. **Planning Considerations.** In planning a passage of lines, the platoon leader, must consider the tactical factors and procedures.

(1) The passage should facilitate transition to follow-on missions through the use of multiple lanes or lanes wide enough to support doctrinal formations for the passing units.

(2) Deception techniques, such as the use of smoke, may be employed to enhance security during the passage.

(3) The controlling commander must clearly define the battle hand over criteria and procedures used during the passage. His order should cover the roles of both the passing unit and the stationary unit and the use of direct and indirect fires. If necessary, he also specifies the location of the battle hand-over line (BHL) as part of the unit's graphic control measures. For a forward passage, the BHL is normally the LD for the passing force. In a rearward passage, it is normally a location in direct fire range of the stationary force. In general, a defensive hand over is complete when the passing unit is clear and the stationary unit is ready to engage the enemy. Offensive hand over is complete when the passing unit has deployed and crossed the BHL.

(4) The passing and stationary units coordinate obstacle information including the locations of enemy and friendly obstacles, existing lanes and or bypasses, and guides for the passage.

(5) Air defense coverage is imperative during the high-risk passage operation. Normally, the stationary unit will be responsible for providing air defense thus allowing the passing unit's air defense assets to move with it.

(6) Responsibility for CSS actions such as vehicle recovery or casualty evacuation in the passage lane must be clearly defined for both passing and stationary units.

(7) To enhance command and control during the passage, the platoon will collocate a command and control element, normally the platoon leader or platoon sergeant, with a similar element from the stationary or moving unit.

b. **Reconnaissance and Coordination.** Detailed reconnaissance and coordination are critical in a passage of lines, both in dealing with the planning factors outlined previously and in ensuring the passage is conducted quickly and smoothly. The platoon leader normally conducts all necessary reconnaissance and coordination for the passage. At times, he may designate the platoon sergeant or squad leader to conduct liaison duties for reconnaissance and coordination. The following items of information are coordinated (an asterisk(*) indicates items that should be confirmed by reconnaissance):

- Unit designation and composition; type and number of passing vehicles.
- Passing unit arrival time(s).
- Location of attack positions or assembly areas. *
- Current enemy situation.
- Stationary unit's mission and plan (to include OP, patrol, and obstacle locations).
- Location of movement routes, contact points, passage points, and passage lanes. (The use of GPS [or POSNAV] waypoints may simplify this process and speed the passage.)
- Guide requirements.
- Order of march.
- Anticipated actions on enemy contact.
- Requirements for supporting direct and indirect fires, including the location of the RFL. *
- NBC conditions.
- Available CS and CSS assets and their locations. *
- Communications information (to include frequencies, digital data, and near and far recognition signals).
- Criteria for battle hand over and location of the BHL.
- Additional procedures for the passage.

c. **Forward Passage of Lines.** In a forward passage, the passing unit first moves to an assembly area or an attack position behind the stationary unit.

(1) Designated liaison personnel move forward to link up with guides and confirm coordination information with the stationary unit. Guides lead the passing elements through the passage lane.

(2) The platoon conducts a forward passage by employing tactical movement. It moves quickly, uses appropriate dispersal and formations whenever possible, and keeps radio traffic to a minimum. It bypasses disabled vehicles as necessary.

(3) The platoon holds its fire until it passes the BHL or designated fire control measure unless the commander has coordinated fire control with the stationary unit.

(4) Once clear of passage lane restrictions, the unit consolidates at a rally point or attack position and conducts tactical movement in accordance with its orders.

d. **Rearward Passage of Lines.** Because of the increased risk of fratricide during a rearward passage, coordination of recognition signals and fire restrictions is critical.

(1) The passing unit contacts the stationary unit while it is still beyond direct fire range and conducts coordination as discussed previously. Near recognition signals and location of the BHL are emphasized. Additional fire control measures, such as RFLs, may be employed to further minimize the risk of fratricide.

(2) Following coordination, the passing unit continues tactical movement toward the passage lane. Gun tubes are oriented on the enemy, and the passing unit is responsible for its security until it passes the BHL. If the stationary unit provides guides, the passing unit may conduct a short halt to link up and coordinate with them.

(3) The passing unit moves quickly through the passage lane to a designated location behind the stationary unit.

7-4. RELIEF IN PLACE

A relief in place occurs when one unit replaces another unit during offensive or defensive operations in order to preserve the combat effectiveness of committed units. Whenever possible, conduct the relief at night or under other limited visibility conditions. In a relief involving the platoon, the company team commander directs when and how the operation will be conducted.

a. **Planning Considerations.** In planning a relief in place, the platoon leader—

- Issues a fragmentary order (FRAGO).
- Uses an advance party composed of key leaders to conduct detailed reconnaissance and coordination.
- As the relieving unit, adopts the outgoing unit's normal pattern of activity as much as possible.
- As the relieving unit, determines when the platoon will assume responsibility for the outgoing unit's position.
- As the relieving unit, collocates platoon headquarters with the relieved unit's headquarters.
- Maximizes operations security (OPSEC) to prevent the enemy from detecting the relief operation.
- Plans to transfer excess ammunition; wire; petroleum, oil, and lubricants (POL); and other material of tactical value to the incoming unit.
- Controls movement by reconnoitering, designating and marking routes, and providing guides.

b. **Coordination.** The incoming and outgoing leaders must meet to exchange tactical information, conduct a joint reconnaissance of the area, and complete other required coordination for the relief. The two leaders must address passage of command and jointly develop contingency actions for enemy contact during the relief. The relief will be conducted on the communications nets of the outgoing unit. This process will normally include coordination of:

- Location of vehicle and individual fighting positions (to include hide, alternate, and supplementary positions).
- Enemy situation.
- The outgoing unit's tactical plan, to include graphics, platoon and squad fire plans, and individual vehicles' sector sketches.
- Fire support, including indirect fire plans and the time of relief for supporting artillery and mortar units.
- Types of weapon systems being replaced.
- Time, sequence, and method of relief.
- Location and disposition of obstacles and the time responsibility will be transferred.

- Supplies and equipment to be transferred.
- Movement control, route priority, and placement of guides.
- Command and signal information
- Maintenance, logistical support, and evacuation if necessary for disabled vehicles.
- Limited visibility considerations.

(1) Since a relief in place is often conducted during hours of limited visibility, the use of infrared or thermal equipment may speed the operation. Units follow prescribed SOPs to mark positions and routes with infrared lights to facilitate the occupation of or withdrawal from the position. These marking signals should be incorporated into the platoon leader's SOP.

(2) During the exchange of positions, the departing unit hands over any vehicle or individual position range cards to the relief element.

NOTE: During the coordination between M2A3-equipped units (or units equipped with FBCB2), graphics are exchanged digitally to reduce time and increase accuracy. Sector sketches are also exchanged between units. Transferring digital information does not relieve the leader of physically coordinating between units. These units also use the commander's tactical display (CTD) and precision navigation system to move to and away from the position as explained in linkup operations discussed previously.

c. **Conducting the Relief.** The outgoing leader retains responsibility for the area of operations and the mission. He exercises operational control over all subordinate elements of the incoming unit while they complete their portion of the relief. Responsibility passes to the incoming commander when all elements of the outgoing unit are relieved and adequate communications are established. The two relief methods are sequential (elements relieved one at a time) and simultaneous (elements relieved all at once). Relief of individual elements can be conducted in one of two ways:

- By alternate element position. The relieving element occupies a position separate from the relieved element.
- By alternate vehicle and or individual position. The relieving element occupies vehicle or individual fighting positions in the same battle position as the relieved element.

(1) **Sequential Relief.** This is the most time-consuming method. The relieving unit moves to an assembly area to the rear of the unit to be relieved. Subordinate elements are relieved one at a time. This can occur in any order, with the relief generally following this sequence:

- The outgoing and incoming units collocate their headquarters and trains elements to facilitate command and control and the transfer of equipment, ammunition, fuel, water, and medical supplies.
- The first element being relieved (such as a squad) moves to its alternate fighting position or battle position while the relieving element moves into the outgoing element's primary positions. The incoming element occupies individual fighting positions.

- Incoming and outgoing elements complete the transfer of equipment and supplies.
- The relieved element moves to the designated assembly area behind the position.
- Once each outgoing element clears the release point (RP) en route to its assembly area, the next relieving element moves forward.

(2) ***Simultaneous Relief.*** This is the fastest, but least secure, method. All outgoing elements are relieved at once, with the incoming unit normally occupying existing positions, including battle positions and vehicle and individual fighting positions. The relief takes place in this general sequence:

- Outgoing elements move to their alternate battle positions and or vehicle and individual positions.
- Incoming elements move along designated routes to the outgoing elements' primary positions.
- Units complete the transfer of equipment and supplies.
- Relieved elements move to the designated unit assembly area

7-5. AIR ASSAULT OPERATIONS

Through the conduct of combat operations, Bradley infantry platoons may be required to participate in air assault operations as part of the tactical plan. Successful air assault execution is based on a careful analysis of the factors of METT-TC and detailed, precise reverse planning. Basic plans comprising reverse planning and developed for each air assault operation are the ground tactical plan, the landing plan, the air movement plan, the loading plan, and the staging plan. These plans normally are coordinated and developed by the air assault task force (AATF) staff to make the best use of available time. If time is limited, planning steps may be compressed or conducted concurrently; detailed plans and orders may be SOPs or lessons learned in training. Battalion is the lowest level with sufficient personnel to plan, coordinate, and control an air assault operation. When company-size or lower operations are conducted, the bulk of the planning takes place at battalion or higher headquarters. Bradley platoon leaders use FM 90-4 for more detailed information regarding air assault operations. Although it is not the highest priority training in the mechanized infantry battalion, air assault operations and mission tasks should be included in platoon training. To ensure that an air assault is executed in an effective and efficient manner, the platoon leader and platoon sergeant have specific responsibilities they must perform. These responsibilities are outlined in the platoon SOP (IAW FM 90-4).

a. **Ground Tactical Plan.** The foundation of a successful air assault operation is the commander's ground tactical plan, around which subsequent planning is based. The ground tactical plan specifies actions in the objective area to accomplish the mission and address subsequent operations. The ground tactical plan contains essentially the same elements as any other infantry attack but capitalizes on speed and mobility to achieve surprise.

b. **Landing Plan.** The landing plan must support the ground tactical plan. This plan sequences elements into the area of operations to ensure platoons arrive at designated locations and times prepared to execute the ground tactical plan.

c. **Air Movement Plan.** The air movement plan is based on the ground tactical and landing plans. It specifies the schedule and provides instructions for air movement of soldiers, equipment, and supplies from pickup zones and landing zones.

d. **Loading Plan.** The loading plan is based on the movement plan. It ensures soldiers, equipment, and supplies are loaded on the correct aircraft. Platoon integrity is maintained when aircraft loads are planned. Cross loading may be necessary to ensure the survivability of platoon leadership and to ensure that the proper mix of weapons arrive at the LZ in a ready-to-fight configuration. The platoon leader or squad leader should always ensure the aircraft is loaded so dismounting infantrymen react promptly and contribute to mission accomplishment. If not directed by the commander, the platoon leader must develop a bump plan. A bump plan ensures essential soldiers and equipment are loaded ahead of less critical loads in case of aircraft breakdown or other problems.

e. **Staging Plan.** The staging plan is based on the loading plan and prescribes the arrival time of ground units (soldiers, equipment, and supplies) at the PZ in the order of movement. The staging plan includes the disposition of the vehicles left in the staging area and the platoon's linkup plan on return from the mission.

(1) **Disposition of Vehicles.** The platoon leader must develop a security plan in the staging area for the vehicles until the mission is completed and the platoon returns to the PZ. The security plan can be as simple as a coil or herringbone formation for the platoon, or the platoon may be part of a company modified perimeter defense. Instructions for link up of the platoon with its vehicles will also be included.

(2) **Linkup of Vehicles.** The platoon leader's linkup plan must be as detailed as the staging and loading plan. To simplify the linkup, the platoon leader must maintain platoon integrity as much as possible. The platoon leader or company commander should designate a linkup point for each unit to link up with their vehicles on landing. As the aircraft land, the units immediately move to their linkup point, mount their vehicles (if required), and prepare to continue the mission.

7-6. AREA SECURITY OPERATIONS

Area security operations protect specific critical and vulnerable assets or terrain from threat observation and direct fire. They can consist of escorting friendly convoys; protecting critical points such as bridges, command and control installations, or other key and vulnerable sites; or participating in protection of large areas such as airfields. During stability or support operations the platoon may be required to establish OPs, roadblocks or CPs. The platoon normally performs an area security operation when conventional security or combat operations would not work. The platoon may perform area security operations as part of a larger force or as an independent platoon mission. BFV platoons normally conduct area security missions to protect high-value points, areas, or assets. Whether and how much protection a point, area, or asset requires (and the defensive technique chosen) depends on the factors of METT-TC. The platoon leader must integrate his elements into the overall security plan for the area he must protect. Area security operations rely on various techniques, which may include reconnaissance, security, defensive tasks, and offensive tasks.

a. When deploying for area security, the platoon generally moves into a coil formation around the point, area, or asset they must secure. They orient vehicle positions

on likely enemy avenues of approach. If the platoon has engineer support, the engineers dig in the vehicle positions; if not, the vehicles occupy hasty fighting positions.

b. To further improve the position, the platoon employs hasty protective minefields, wire, and other obstacles, as appropriate and available. They emplace wire obstacles outside grenade range of friendly positions. Once they set up vehicle positions and obstacles, the platoon develops a fire plan and submits the plan to higher headquarters. This plan includes integrated direct and indirect fires.

c. In addition to setting up the platoon position around the asset to be secured, the platoon also employs patrols and OPs to enhance security (Figure 7-1). Reconnaissance patrols and combat patrols define the area of operations, gain information on enemy forces, and destroy small dismounted enemy reconnaissance elements. The platoon deploys OPs to observe likely avenues of approach, to provide early warning of enemy activity, and to aid in control of indirect fires.

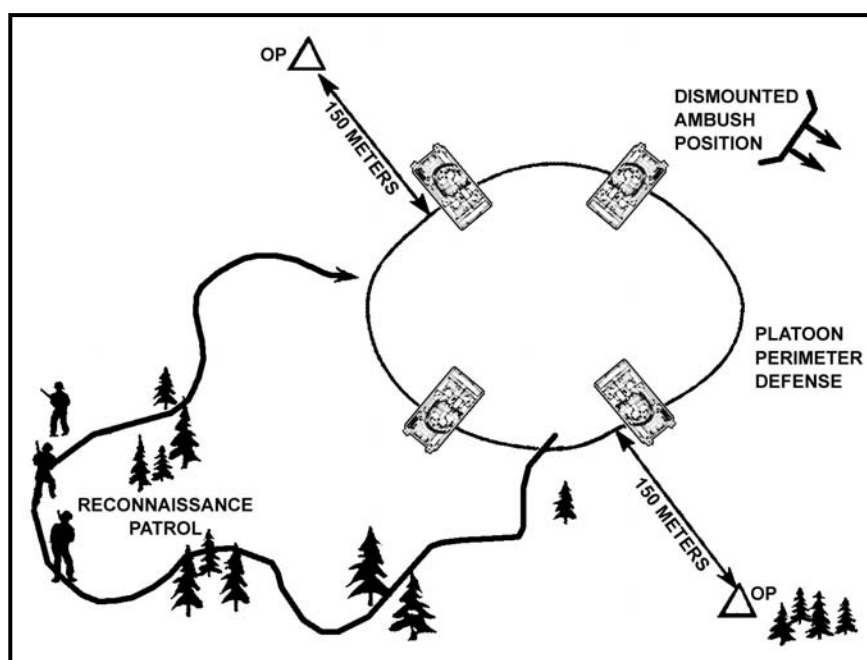

Figure 7-1. Platoon area security dispositions.

7-7. CONVOY AND ROUTE SECURITY

Company and larger organizations usually perform convoy or route security missions. Convoy security provides protection for a specific convoy. Route security aims at securing a specific route for a designated period of time, during which multiple convoys may use the route. These missions include numerous tasks (such as escort, reconnaissance, and combat reaction forces) that become missions for subordinate units. The size of the unit performing the convoy or route security operation depends on many factors including the size of the convoy, the terrain, and the length of the route.

a. **Route Reconnaissance.** In this mission, the platoon leader focuses on the route's trafficability and on enemy forces that might influence the route. The platoon must plan to call for engineer assets to aid in breaching point-type obstacles. Command-detonated devices pose a major threat during route reconnaissance.

b. **Convoy Escort.** The platoon may perform a convoy escort mission either independently or as part of a larger unit's convoy security mission. The convoy escort mission requires that the platoon provide the convoy with limited close-in protection from direct small arms fire. Platoon vehicles include military CSS and C2 vehicles and civilian trucks and buses. Leaders must carefully evaluate the threat before assigning a convoy escort mission to platoon-sized elements.

c. **Command and Control.** Because of the task organization of the convoy escort mission, command and control is especially critical. The relationship between the platoon and the convoy commander must provide unity of command and effort if combat operations are required during the course of the mission. In most cases, the BFV platoon will execute the escort mission under the control of the security force commander, who is usually under operational control (OPCON) or attached to the convoy commander. It is vital that the convoy commander issues a complete OPORD to all convoy vehicle commanders before executing the mission because the convoy may itself be task-organized from a variety of units, and some vehicles may not have tactical radios. The order should follow the standard five-paragraph OPORD format, but special emphasis should be placed on:

- Route of march (to include a strip map for each vehicle commander).
- Order of march.
- Actions at halts.
- Actions in case of vehicle breakdown.
- Actions on contact.
- Chain of command.
- Communications and signal information.

d. **Tactical Disposition.** During all escort missions, the convoy security commander and BFV platoon leader must establish and maintain security in all directions and throughout the platoon. As noted, several factors, including convoy size, affect this disposition. The key consideration is whether the platoon is operating as part of a larger escort force or is executing the escort mission independently. Additional METT-TC considerations include: the employment of BFVs by section and the employment of rifle squads during the mission (Length of convoy, terrain and the enemy will determine placement of sections and employment of rifle squads (fire teams riding in BFVs or in escorted vehicles). Maintain unit integrity in convoy vehicles at team or squad.

(1) **Large-scale Escort Missions.** When sufficient escort assets are available, the convoy commander will usually organize the convoy into three distinct elements: advance guard, close-in protective group, and rear guard. Figure 7-2, page 7-14, shows a convoy in which the BFV platoon is part of a company team-size escort force.

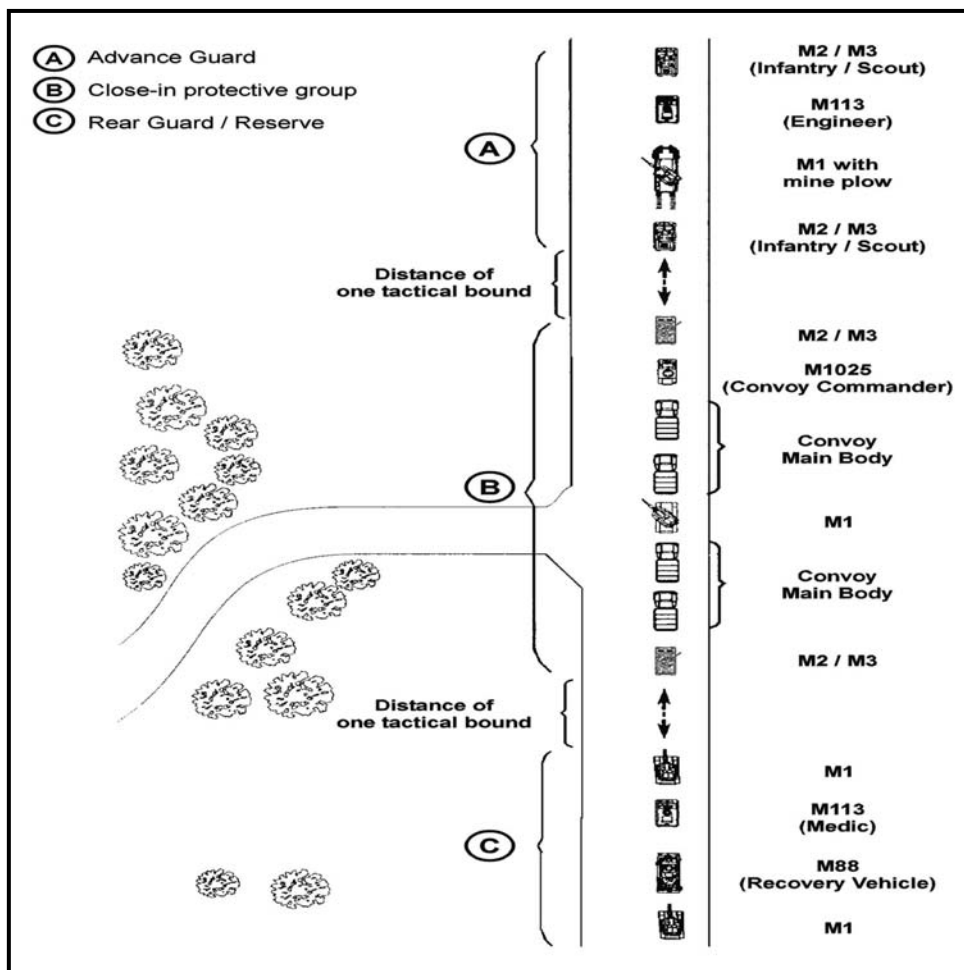

Figure 7-2. BFV platoon as part of larger escort force.

(a) The advance guard reconnoiters and proofs the convoy route. It searches for signs of enemy activity such as ambushes and obstacles. Within its capabilities, it attempts to clear the route, and it provides the convoy commander with early warning before the arrival of the vehicle column. In some cases, an individual BFV platoon vehicle, a section, or the entire platoon may be designated as part of the advanced guard and may receive a tank with a mine plow or mine roller.

(b) The BFV platoon normally will be tasked organized to operate within the close-in protective group. This group provides immediate, close-in protection for the vehicle column with escort vehicles positioned either in the column or on the flanks. The convoy commander's vehicle is located in this group.

(c) The rear guard follows the convoy. It provides security in the area behind the main body of the vehicle column, often moving medical and recovery assets. Again, an individual vehicle, a section, or the entire BFV platoon may be part of this element.

NOTE: The convoy commander may also designate the BFV or tank platoon as part of a reserve (reaction) force for additional firepower on enemy contact. The

reserve will either move with the convoy or be located at a staging area close enough to provide immediate interdiction against the enemy.

(2) **Independent Convoy Escort.** When the BFV platoon executes a convoy escort mission independently, the convoy commander and platoon leader disperse the BFVs throughout the convoy formation to provide forward, flank, and rear security. Whenever possible, wingman BFVs should maintain visual contact with their leaders. Engineer assets, if available, should be located near the front to respond to obstacles. At times, engineer assets may be required to move ahead of the convoy with scouts to proof the convoy route. Figure 7-3 illustrates this type of escort operation. In some independent escort missions, variations in terrain along the route may require the platoon to operate using a modified traveling overwatch technique. Figure 7-4 depicts such a situation. It shows one section leading the convoy while the other trails the convoy. Dispersion between vehicles in each section is sufficient to provide flank security. Depending on the terrain, the trail section may not be able to overwatch the movement of the lead section.

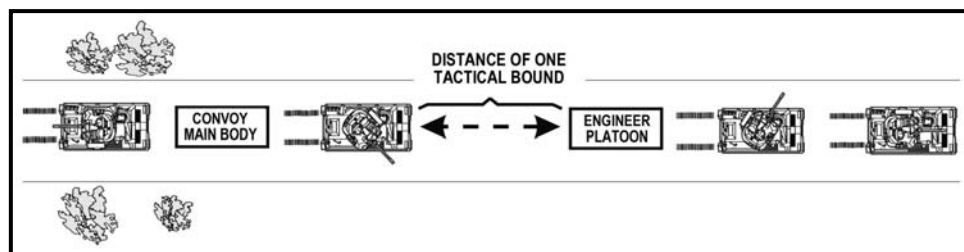

Figure 7-3. Platoon performing convoy escort independently.

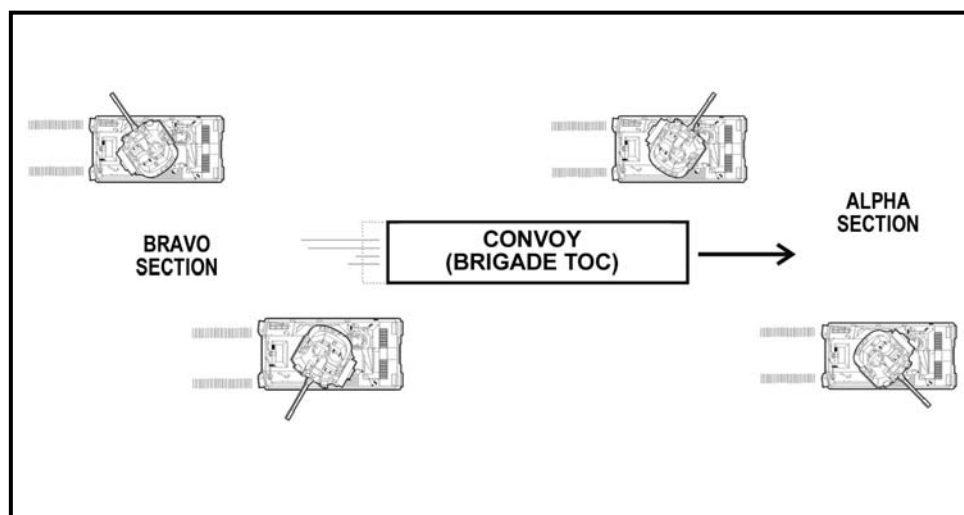

Figure 7-4. Platoon using modified traveling overwatch.

e. **Actions on Contact.** As the convoy moves to its new location, the enemy may attempt to harass or destroy it. This contact usually will usually occur in the form of an ambush, often with the use of a hastily prepared obstacle. The safety of the convoy rests on the speed and effectiveness with which escort elements can execute appropriate

actions on contact. Based on the factors of METT-TC, portions of the convoy security force, such as the BFV platoon or a BFV section, may be designated as a reaction force. The reaction force performs its escort duties, conducts tactical movement, or occupies an assembly area, as required, until enemy contact occurs and the convoy commander gives it a reaction mission.

f. **Actions at an Ambush.** An ambush is one of the more effective ways to interdict a convoy. Reaction to an ambush must be immediate, overwhelming, and decisive. Actions on contact must be planned for and rehearsed so they can be executed quickly.

(1) In almost all situations, the platoon will take several specific, instantaneous actions when it reacts to an ambush. These steps, illustrated in Figures 7-5 and 7-6, include:

- As soon as they acquire an enemy force, the escort vehicles take action toward the enemy (Figure 7-5). They seek covered positions between the convoy and the enemy and suppress the enemy with the highest volume of fire permitted by the ROE. Contact reports are submitted to higher headquarters as quickly as possible.
- The convoy commander retains control of the convoy vehicles and continues to move them along the route at the highest possible speed (Figure 7-5).
- Convoy vehicles, if armed, may return fire only if the escort has not positioned itself between the convoy and the enemy force.
- The platoon leader or the convoy commander may request that any damaged or disabled vehicles be abandoned and pushed off the route (Figure 7-6).
- The escort leader (in the example included here, this is the BFV platoon leader) uses spot reports (SPOTREPs) to keep the convoy security commander informed. If necessary, the escort leader or the convoy security commander can request support from the reaction force, call for, and adjust indirect fires.

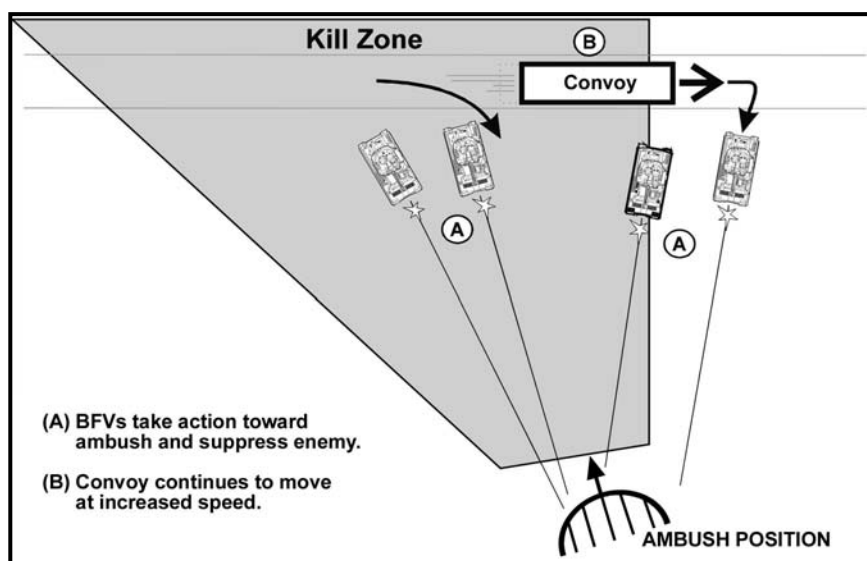

Figure 7-5. Convoy escort actions toward ambush.

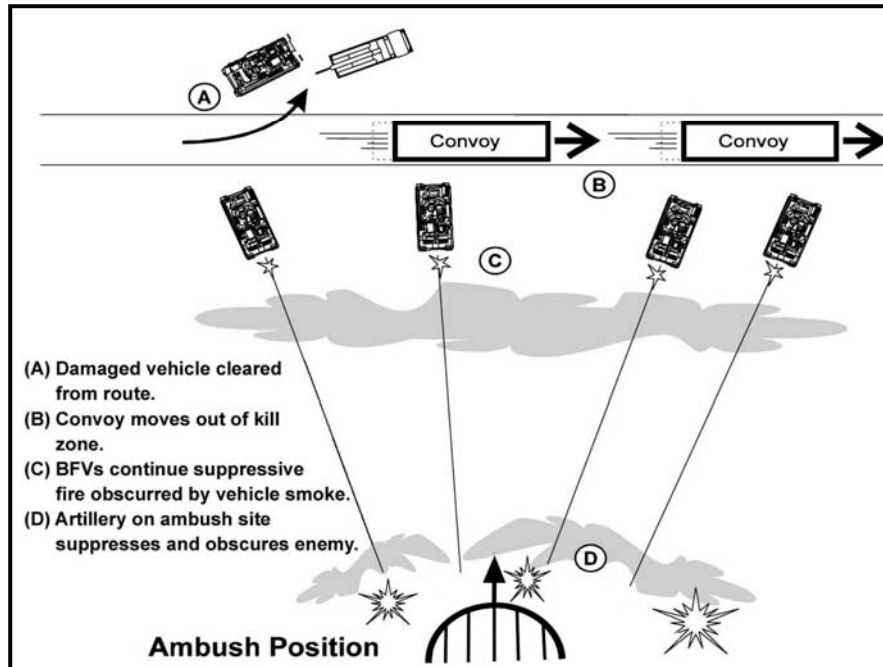

Figure 7-6. Convoy continues to move.

(2) Once the convoy is clear of the kill zone, the escort element executes one of the following courses of action:

- Continues to suppress the enemy as combat reaction forces move to support (Figure 7-7, page 7-18).
- Assaults the enemy (Figure 7-8, page 7-18).
- Breaks contact and moves out of the kill zone.

(3) In most situations, BFVs will continue to suppress the enemy or execute an assault. Contact should be broken only with the approval of the BFV platoon's higher commander.

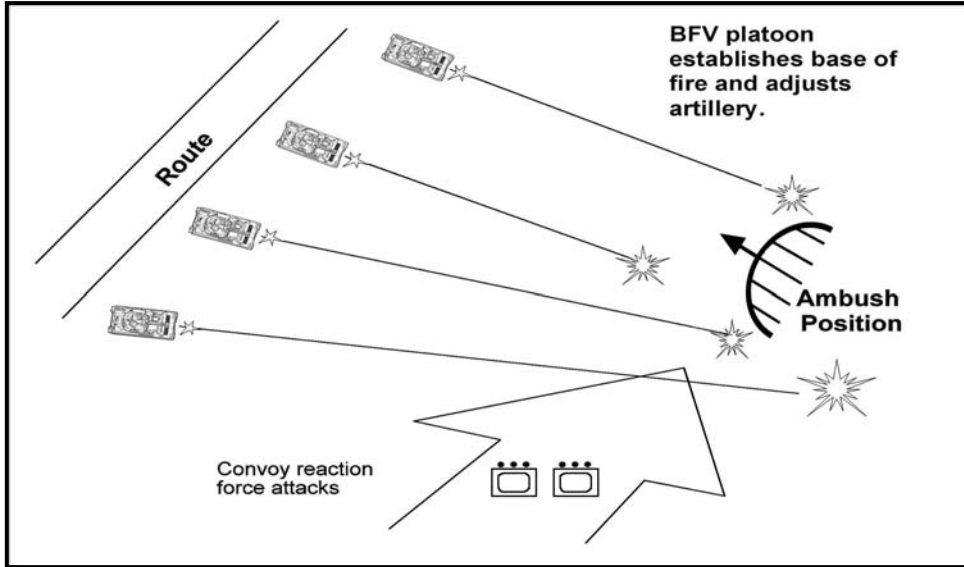

Figure 7-7. Escort suppresses ambush for reaction force attack.

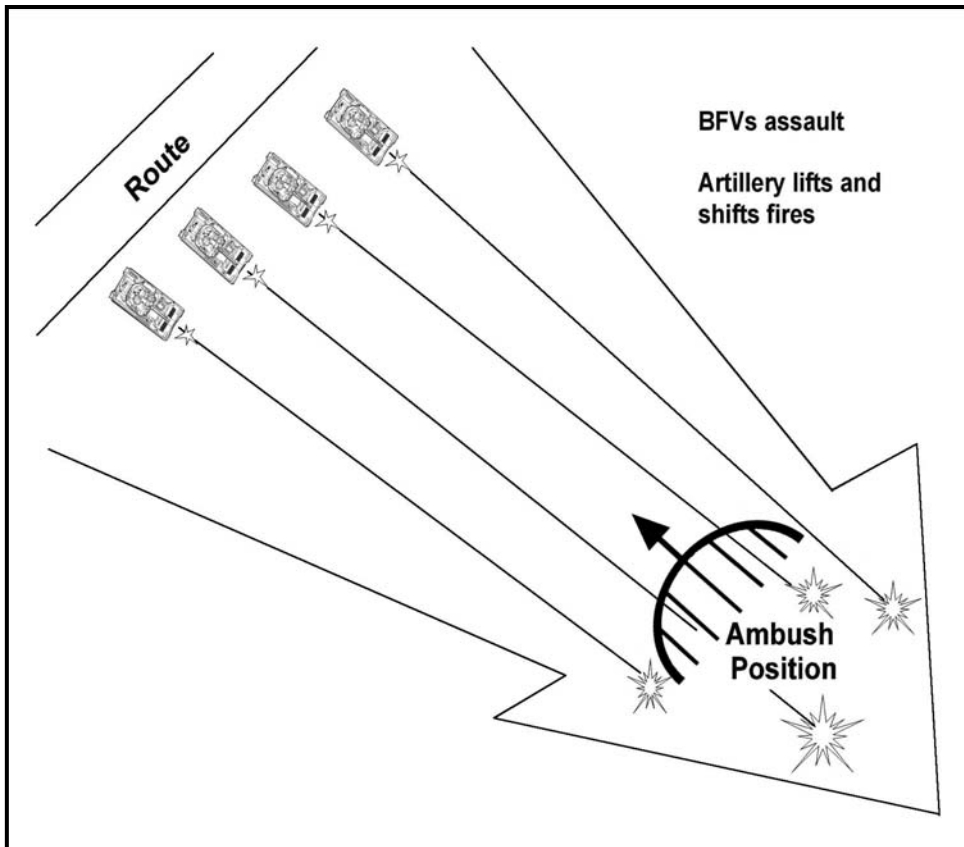

Figure 7-8. Escort assaults ambush.

g. **Actions at an Obstacle.** Obstacles are a major impediment to convoys. The purpose of reconnaissance ahead of a convoy is to identify obstacles and either breach them or find bypasses. In some cases the enemy or its obstacles may avoid detection by the reconnaissance element.

(1) Obstacles can be used to harass the convoy by delaying it. If the terrain is favorable, the obstacle may be able to stop the convoy all together. Obstacles may canalize or stop the convoy to set up an enemy ambush. When an obstacle is identified, the convoy escort faces two problems: reducing or bypassing the obstacle and maintaining protection for the convoy. Security becomes critical, and actions at the obstacle must be accomplished very quickly. The convoy commander must assume that the enemy is covering the obstacle with direct and indirect fire weapon systems.

(2) To reduce the time the convoy is halted and to reduce its vulnerability, the following actions should occur when the convoy escort encounters a point-type obstacle:

- The lead element identifies the obstacle and directs the convoy to make a short halt and establish security. The convoy escort overwatches the obstacle (Figure 7-9) and requests the breach element force to move forward.
- The convoy escort maintains 360-degree security of the convoy and provides overwatch as the breach force reconnoiters the obstacle in search of a bypass.

(3) Once all reconnaissance is complete, the convoy commander determines which of the following courses of action he will take.

- Bypass the obstacle.
- Breach the obstacle with assets on hand.
- Breach the obstacle with reinforcing assets.

(4) The convoy security commander relays a SPOTREP and requests support by combat reaction forces, engineer assets (if they are not part of the convoy), and aerial reconnaissance elements. Artillery units are alerted to prepare to provide fire support.

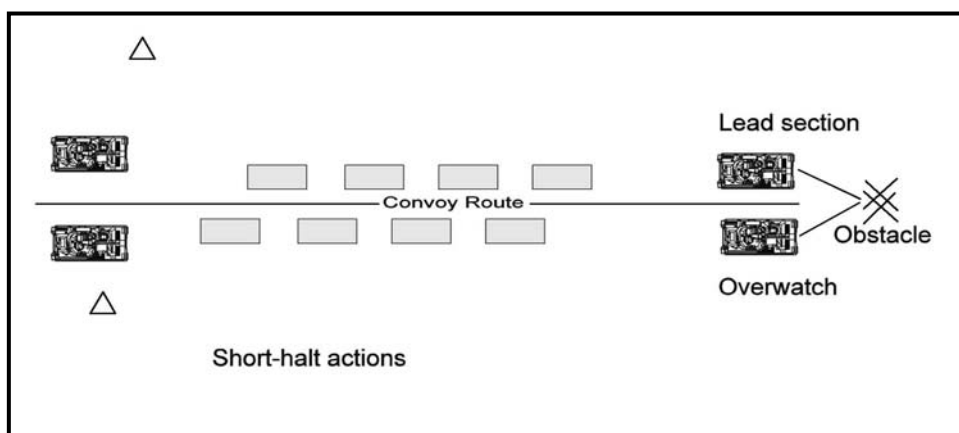

Figure 7-9. Convoy escort overwatches an obstacle.

h. **Actions During Halts.** During a short halt, the convoy escort remains alerted for possible enemy activity. If the halt is for any reason other than an obstacle, the following actions should be taken:

- The convoy commander signals the short halt and transmits the order via tactical radio. All vehicles in the convoy assume a herringbone formation.

- If possible, escort vehicles are positioned up to 100 meters beyond the convoy vehicles that are just clear of the route (Figure 7-10). Escort vehicles remain at the ready and establish local security.
- When the order is given to move out, convoy vehicles reestablish movement formation, leaving space for escort vehicles (Figure 7-11). Once the convoy is in column, local security elements (if used) return to their vehicles, and the escort vehicles rejoin the column (Figure 7-12).
- The convoy resumes movement.

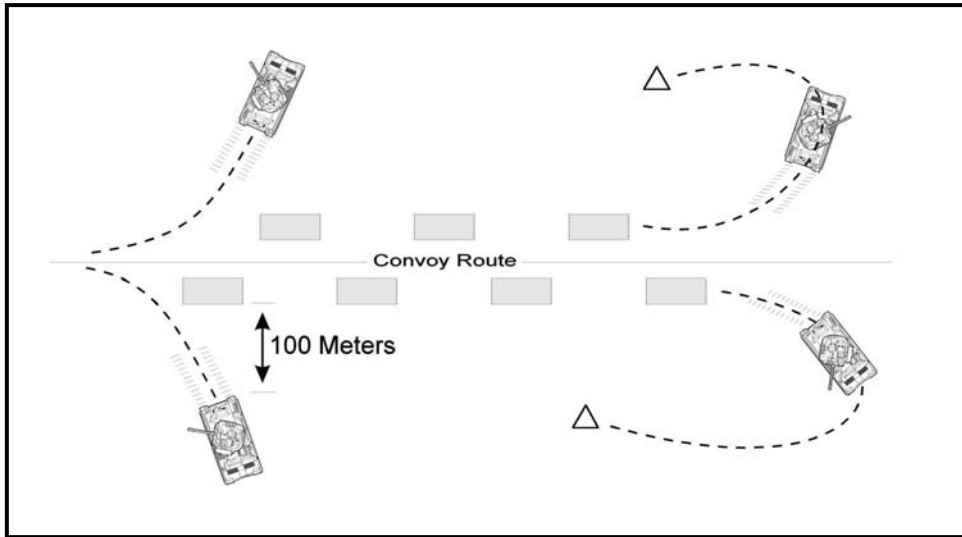

Figure 7-10. Convoy assumes herringbone formation.

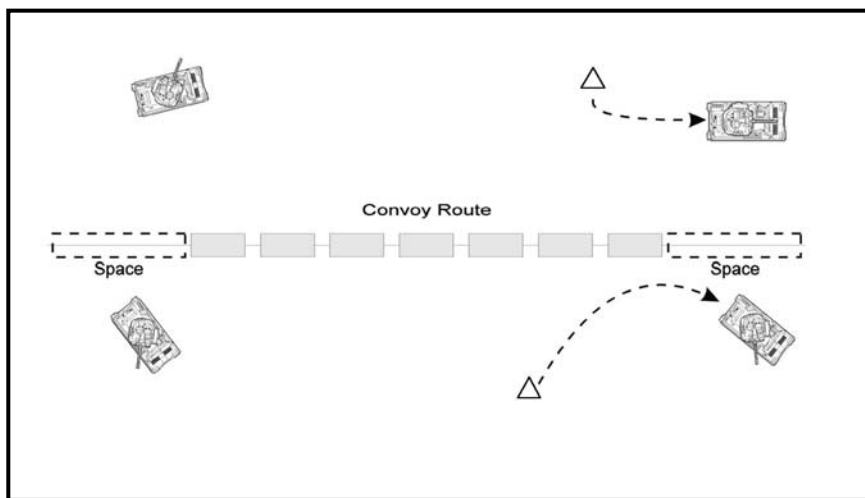

Figure 7-11. Convoy moves back into column formation.

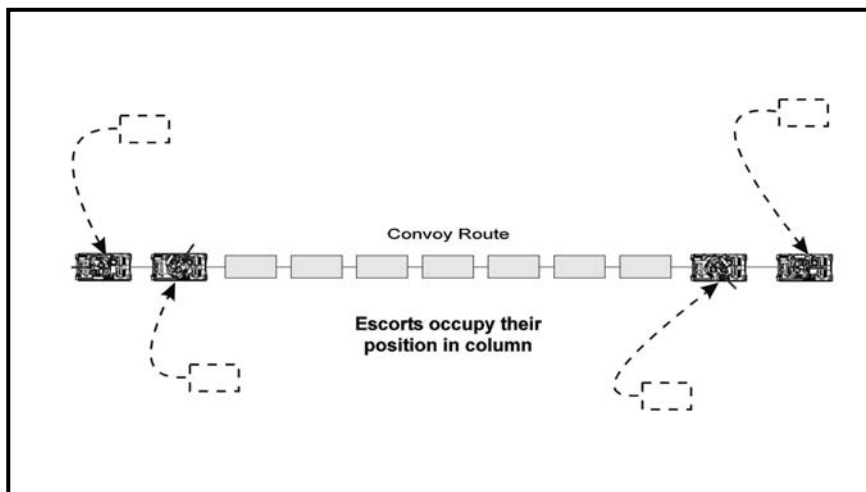

Figure 7-12. Convoy escort vehicles rejoin column.

7-8. CHECKPOINTS, ROADBLOCKS, AND OBSERVATION POSTS

Construction and manning of checkpoints, roadblocks, and observation points are high-frequency tasks for an infantry company and subordinate elements when they must establish area security during stability operations. (Figure 7-13, page 7-23, shows an example of a deliberate CP.)

- **Checkpoints.** A CP is a predetermined point used as a means of controlling movement such as a place where military police check vehicular or pedestrian traffic to enforce circulation control measures and other laws, orders, and regulations.
 - **Roadblocks.** A roadblock is used to limit the movement of vehicles along a route or to close access to certain areas or roads. Checkpoints and roadblocks can be either deliberate or hasty with the primary difference being the extent of planning and preparation conducted by the establishing force.
 - **Observation Posts.** An OP is a position from which military observations are made or fire directed and adjusted, and which has appropriate communications. They are both overt (conspicuously visible, unlike their tactical counterparts) and deliberately constructed. Observation posts are similar in construction to bunkers and are supported by fighting positions, barriers, and patrols.
- a. **Purposes.** The platoon may be directed to establish a CP, roadblock, or OP for the following reasons.
- To show a military presence to all parties and to the population in the area.
 - To survey all activity in the terrain, along roads, and in inhabited areas.
 - To check and or inspect and register all personnel and vehicles in and out of the controlled area.
 - To survey airspace, coastal areas, airfields, cease-fire lines, and borders.
 - To deter illegal movement.
 - To create an instant roadblock.
 - To control movement into the area of operations or on a specific route.
 - To prevent smuggling of contraband.

- To enforce the terms of peace agreements.
- To ensure proper use of routes by both civilian and military vehicles.

b. **Planning and Establishing.** The layout, construction, and manning of CPs, roadblocks, and OPs should reflect the factors of METT-TC, especially the time available for emplacing them. The layout of a deliberate CP can be found in FM 71-1. The following procedures and considerations may apply:

- Position the CP or roadblock where it is visible and where traffic cannot turn back, get off the road, or bypass without being observed.
- Position a combat vehicle off the road, but within sight, to deter resistance to soldiers manning the CP. The vehicle should be in a hull-down position and protected by local security. It must be able to engage vehicles attempting to break through or bypass the CP.
- Place obstacles in the road to slow or canalize traffic into the search area.
- Establish a reserve.
- Establish wire communications in the CP area to connect the CP bunker, the combat vehicle, the search area, security forces, the rest area, and any other elements involved in the operation.
- Designate the search area. If possible, it should be below ground to provide protection against such incidents as the explosion of a booby-trapped vehicle. Establish a parking area adjacent to the search area.
- If applicable, CP personnel should include linguists.
- Establish an early warning system around the perimeter of the OP (trip flares, empty cans, dry branches, and so on).
- Prepare shelters and defensive positions.

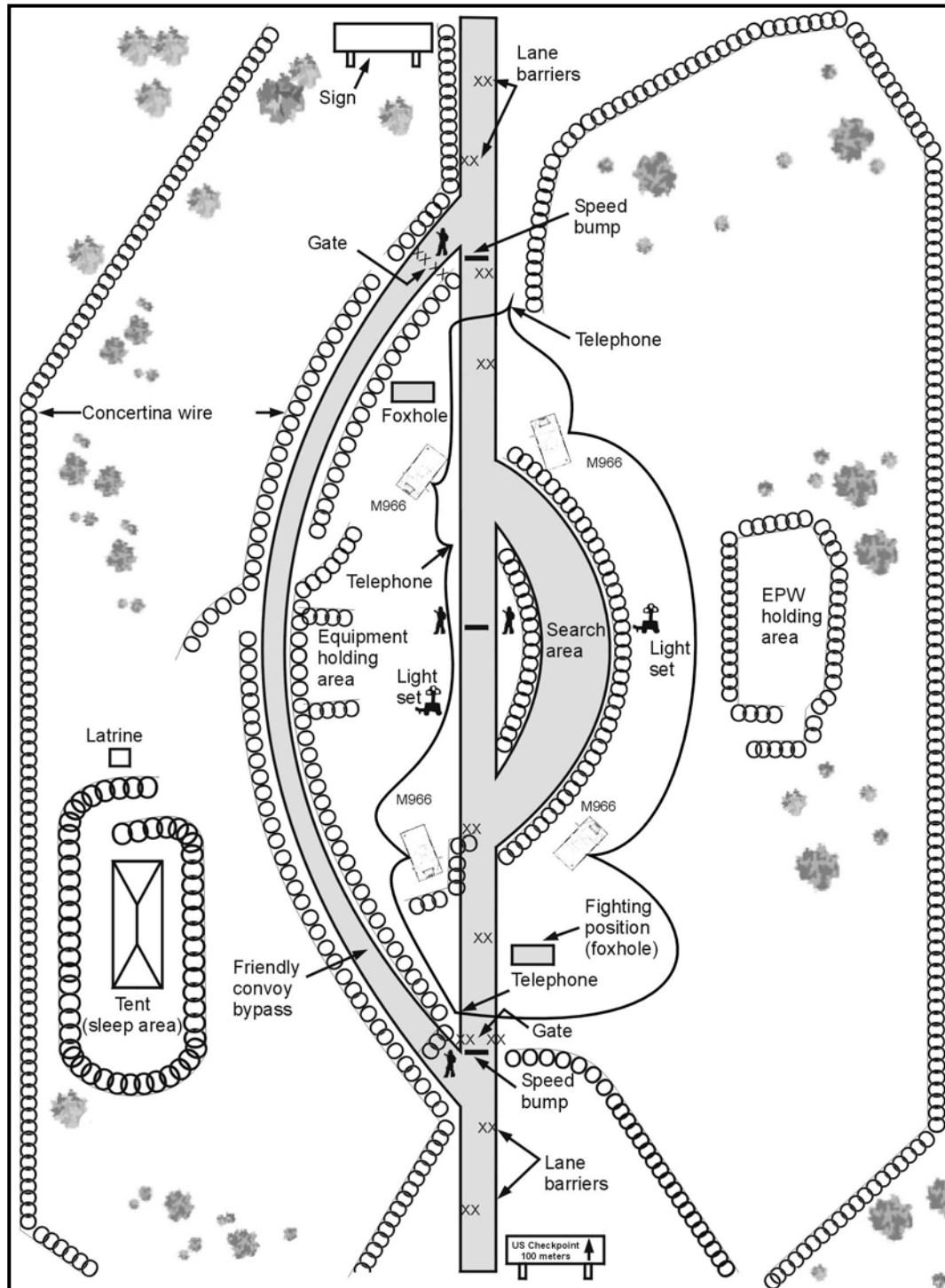

Figure 7-13. Example of a deliberate CP.

c. **Manning Observation Posts and Checkpoints.** When manning OPs and CPs proper order and a systematic approach must be emphasized. Personnel must behave so that no misunderstanding occurs. The personnel manning the CP must be in complete control of the surrounding terrain.

(1) Although the OP is usually manned on a 24-hour basis, it may be manned only by day or night. During darkness, at least two persons must be in the OP position—one observes while the other is resting. In remote areas, or if the situation in the area is tense, more personnel man the OP for security and observation.

(2) A minimum of two soldiers should man the CP depending on traffic and the general situation. One soldier examines people and vehicles and the other soldier covers the area where people and vehicles are checked. The soldier covering the other area is armed and has easy access to radio and telephone. If more soldiers are manning the CP, one of them should be ready to set up obstacles to stop vehicles trying to force their way through the CP.

d. **Communications.** All OPs and CPs are connected to their unit or directly to the battalion operations center by radio and telephone. A spare radio and batteries should be supplied to the OP and CP, especially to remote OPs located in dangerous areas. Radio and telephone checks are carried out at least twice every 24 hours (three times is recommended). Special code words must be prepared for use in certain situations. Conversation must be coded. Reserve frequencies must be available. OPs and CPs of great operational value may be connected by direct landline to ensure rapid coordination in urgent situations.

e. **Equipment.** Many items are used to reinforce a roadblock, CP, or OP.

(1) Some of the recommended equipment includes:

- Barrels filled with sand, water, or heavy concrete blocks (emplaced to slow and canalize vehicles).
- Concertina wire (emplaced to control movement around the CP).
- Secure facilities for radio and wire communications with the controlling headquarters.
- First aid kit or a medic if available.
- Sandbags for defensive positions.
- Bunker construction material.
- Binoculars, night vision devices, and or flashlights.
- Long-handled mirrors (used to inspect vehicle undercarriages).
- Signs stating the speed limit into and out of the CP. (The text of these signs must be written in English and the local language.)

(2) Elements manning a deliberate CP may require access to specialized equipment such as:

- Floodlights.
- Duty log.
- Flag and unit sign.
- Barrier pole that can be raised and lowered.
- Generators with electric wire.

f. **Control.** During periods in which the civilian administration is not functioning, refugees will be routinely traveling throughout the area. All soldiers participating in these operations must fully understand the procedures for appropriately identifying personnel and for controlling personnel and vehicles moving through their AO.

(1) **Personnel Identification.** People who have permission to enter a sector are regulated by special instructions to the patrol conducting the operation. Often local and civilian employees, mayors, and chiefs of tribes in villages in the AO are given special

identification (ID) cards and may pass without being checked. These special ID cards must be registered. The primary reasons for checking people will be for identification and to prevent illegal items being brought into the AO through the CP. Personnel must identify themselves with an ID card, passport, and so on. Such ID cards are written in the local language. Examples of different ID cards must be kept in the CP.

(2) **Personnel Control.** Personnel control is conducted in different ways. Personnel should watch for people acting strangely or with bulging clothing. If there is a danger of car bombs, special attention should be paid to cars containing only one person. When conducting body searches, personnel should feel along clothes and not just pat them. Special attention must be paid to the lower parts of the back and from the shoes up to the knees. Armpits also must be checked. The wide trousers used by some cultures should be carefully examined. Personnel should also check boots and hats.

(3) **Checking Women and Clerical Personnel.** Making a body search of women and clerical personnel is often difficult in Moslem countries, and may lead to strong reactions. The commander must thoroughly discuss this with mayors and other leaders, and the procedure used must be consistent with agreements and treaties. Usually women are only checked with a metal detector. Elderly women often may remain in the vehicle during inspection of a car. If there is a suspicion that the “rules” are being misused, then other and better checks must be made. The battalion commander makes these decisions.

**CHAPTER 8
COMBAT SUPPORT**

The task force commander is responsible for effective CS. Mortars, artillery, air defense artillery, combat engineers, and aviation assets provide CS for the platoon. The task force commander decides how to employ assets based on his estimate of the situation. He attaches supporting elements to the company team, or he places CS elements under OPCON, in DS, or in GS of the company team. The company team commander may attach supporting elements to the platoon. The platoon leader must know the employment considerations and abilities of all CS assets.

Section I. INDIRECT FIRE SUPPORT

The main indirect-fire support available to the BFV platoon includes mortars and field artillery (Table 8-1). This section discusses the responsibilities, considerations, and procedures for employing all the indirect-fire assets supporting the BFV platoon. (FM 6-30 discusses in detail how to call for and adjust indirect fires.)

WEAPON	AMMUNITION		RANGE (in meters)	
	MODEL	TYPE	MINIMUM	MAXIMUM
60-mm M224	M720/M889	HE	70	3,500
	M722	WP	70	3,500
	M721	ILLUM	200	3,500
	M302A1	WP	35	1,830
	M83A3	ILLUM	725	950
	M49A4	HE	45	1,830
81-mm M29A1	M374A2	HE	70	4,600
	M372A3	HE	73	4,790
	M375A2	WP	73	4,595
	M301A3	ILLUM	100	3,950
81-mm M252	M281/M889	HE	80	5,800
	M374A3	HE	73	4,790
	M819	RP	300	4,800
	M375A2	WP	73	4,595
	M853	ILLUM	300	5,060
	M301A3	ILLUM	100	3,950
120-mm M120	M77	HE	200	7,200
	M68	WP	200	7,200
	M91	ILLUM	200	7,100
	M933	HE (PD)	200	7,200
	M934	HE (MOF)	200	7,200
	M929	WP	200	7,200
	M930	ILLUM	200	7,200
HE High-explosive WP White phosphorus ILLUM Illumination RP Red phosphorus				

Table 8-1. Mortar capabilities.

8-1. FIRE PLANNING

The BFV platoon must understand how the task force plans and executes indirect fires in support of the commander's scheme of maneuver. The task force commander attaches or

places a FIST under OPCON to help the platoon call for fires. The task force FSO advises and integrates indirect fire support into the scheme of maneuver.

8-2. FIRE SUPPORT MATRIX

The fire-planning process begins at higher echelons and continues down through the company team FSOs and other key personnel, to include the BFV platoon leader. The effectiveness of this process depends on continuous interaction and feedback from the lower echelons upward. Key functions include refinement and confirmation of target locations and execution of events. Specific responsibilities include those listed on the fire support execution matrix. The matrix shows the leader who bears responsibility for each target, when the responsible party should execute the target, and what means (artillery, mortars, CAS) he or they should use. Figure 8-1 shows an example fire support matrix developed by a task force FSO. It shows maneuver elements along the left side and the different phases of the mission along the top. It shows the platoon's role throughout the operation. The preparer should always include the platoon as a subunit in the matrix.

UNIT	PHASE/TRIGGER LINES			
	PL MACE	PL BOW	PL ARROW	PL BLUE
5-87				
A-CO			BB 3401	BB 3111 BB 0012 -MORTAR PRIORITY-
B-CO	BB 0001 BB 3003	BB 3001 -MORTAR PRIORITY- +FA PRIORITY-		
C-CO			BB 3010	
AT		BB 0007 BB 3002	BB 0013 BB 0009	BB 0015 GP B1B -FA PRIORITY-
RECON PLATOON	BB 0029 BB 3004	BB 0017		
MORTARS	PSN A1, A2	BB 3001 PSN B1	PSN B2, C1	BB 3111 PSN C2
FA ORGANIZATION FOR COMBAT		MORTAR POSITIONS		AMMUNITION AVAILABLE
4-5 FA (105) DS TO 2 BDE		PSN A1 123455		30 MIN ARTY SMOKE 20 MIN MORTAR SMOKE 30 MIN ARTY ILLUM 30 MIN MORTAR ILLUM
FS COORD MEASURES		A2 124456		
CFL: PL BOW		PSN B1 1274556		
O/O CFL: PL ARROW		B2 128452		
O/O CFL:		PSN C1 131500		TACAIR
O/O CFL:		C2 130495		4 TF SORTIES 4 ACAs (#) 20-23 (SEE ACA OVERLAY)
FASCAM		BDE CDR TGT. GUIDANCE		HIGH PAYOFF TARGETS
TF ALLOCATION: 2 BDE 2		DEST ADA		ZSU 32-4, SA 9
PLANNED:		NEUT RECON ELEMENTS		MRB's CRP (3 BMP's, 1 BRDM)
195450 200444		SUPPRESS AR, MECH PLTS		ENGINEERS
199455 221456				
COC IS: - A -, - B -, - C -, FSO WITH - A - FSE BEING O/O BN FSE				
S	DAY - 1 -	FA DS BN CDR: H70__	A FSO: A99__	FA FDC: __H55__
O	CF 2:	45.20 BDE FSCOORD: E24__	B FSO: B99__	MORTAR FDC: __U55__
I	FD 1:	55.70 BDE FSO: J99__	C FSO: C99__	
	MORTAR:	32.60 BN FSO: C99__	OIC - O - NCOIC - N - RATELO - R -	
COORDINATING INSTRUCTIONS:				
1. TARGET ALLOCATION: A 3, B 3, C 2				
2. CUTOFF FOR TARGET SUBMISSION 052200 OCT.				
3. SURVEY TARGETS FOR A, B, MORTAR FIRING POSITIONS. FSO's TAKE SURVEY TO NEXT LOCATION.				

Figure 8-1. Example of a fire support matrix.

8-3. CALL FOR FIRE

The task force fire support matrix might require the BFV platoon to call for and adjust its own indirect-fire support. The matrix might also designate platoon targets. The platoon uses

these preplanned artillery targets to call for and adjust indirect fire. Either a soldier or an FO can prepare and request a call for fire. However, to receive immediate indirect-fire support, the observer must plan targets and follow proper call-for-fire procedures. If available, he should use a GPS and laser range finders. The call for fire must include certain elements and might include others.

a. **Required Elements.** Calls for fire must include—

(1) **Observer Identification and Warning Order.** Observer identification tells the FDC who is calling. It also clears the net for the duration of the call. The warning order tells the FDC the type of mission and the method of locating the target. The types of indirect fire missions are as follows:

- Adjust fire—Use this command when uncertain of target location.
- Fire for effect—Use this command for rounds on target; no adjustment.
- Suppress—Use this command to obtain fire quickly.
- Immediate suppression—Use this command to indicate the platoon is already being engaged by threat; must give target identification.

(2) **Target Location Methods.** The observer sends the target location as six digits (letters and numbers). Before the first adjusting rounds are fired, the observer gives the direction in mils. The FDC must know the observer's exact location. The observer sends observer-target (OT) direction (to the nearest 10 mils) from his position to the target. He specifies which target location method to use:

- Grid (Figure 8-2).
- Polar (Figure 8-3, page 8-4).
- Shift from a known point (Figure 8-4, page 8-4).
- Range shifts and lateral shifts (Figure 8-5, page 8-5).

INITIAL FIRE REQUEST	
Observer	FDC
Z57, THIS IS 271, ADJUST FIRE, OVER.	THIS IS Z57, ADJUST FIRE, OUT.
GRID NK180513, OVER.	GRID NK180513, OUT.
INFANTRY PLATOON IN THE OPEN, ICM IN EFFECT, OVER.	INFANTRY PLATOON IN THE OPEN, ICM IN EFFECT, OVER.
MESSAGE TO OBSERVER	
Observer	FDC
Z, 2 ROUNDS, TARGET, AF1027, OVER.	Z, 2 ROUNDS, TARGET IS AF1027, OUT.
DIRECTION 1680, OVER.	DIRECTION 1680, OUT.
NOTE: Send direction before or with the first subsequent correction.	

Figure 8-2. Example fire mission (grid).

INITIAL FIRE REQUEST	
Observer	FDC
Z56, THIS IS Z31, FIRE FOR EFFECT, POLAR. OVER.	THIS IS Z56, FIRE FOR EFFECT, POLAR, OUT.
DIRECTION 4520, DISTANCE 2300, DOWN 35. OVER.	DIRECTION 4520, DISTANCE 2300, DOWN 35, OUT.
INFANTRY COMPANY IN OPEN, ICM, OVER.	INFANTRY COMPANY IN OPEN, ICM, OVER.
MESSAGE TO OBSERVER	
Observer	FDC
Y, VT, 3 ROUNDS, TARGET, AF2036, OVER.	Y, VT, 3 ROUNDS, TARGET AF2036, OUT.

Figure 8-3. Example fire mission (polar plot).

INITIAL FIRE REQUEST	
Observer	FDC
H66 THIS IS H44, ADJUST FIRE, SHIFT AA7733, OVER.	THIS IS H66, ADJUST FIRE, SHIFT AA7733, OUT.
DIRECTION 5210, LEFT 380, ADD 400, DOWN 35, OVER.	DIRECTION 5210, LEFT 380, ADD 400, DOWN 35, OUT
COMBAT OP IN OPEN, ICM IN EFFECT, OVER.	COMBAT OP IN OPEN, ICM IN EFFECT, OUT.
MESSAGE TO OBSERVER	
Observer	FDC
H, 1 ROUND, TARGET AA7742, OVER.	H, 1 ROUND, TARGET, AA7742, OUT.
NOTE: Shift from a known point is performed when the observer and FDC have a common known point. The observer sends OT line, then determines the lateral and range shifts.	

Figure 8-4. Example fire mission (shift from a known point).

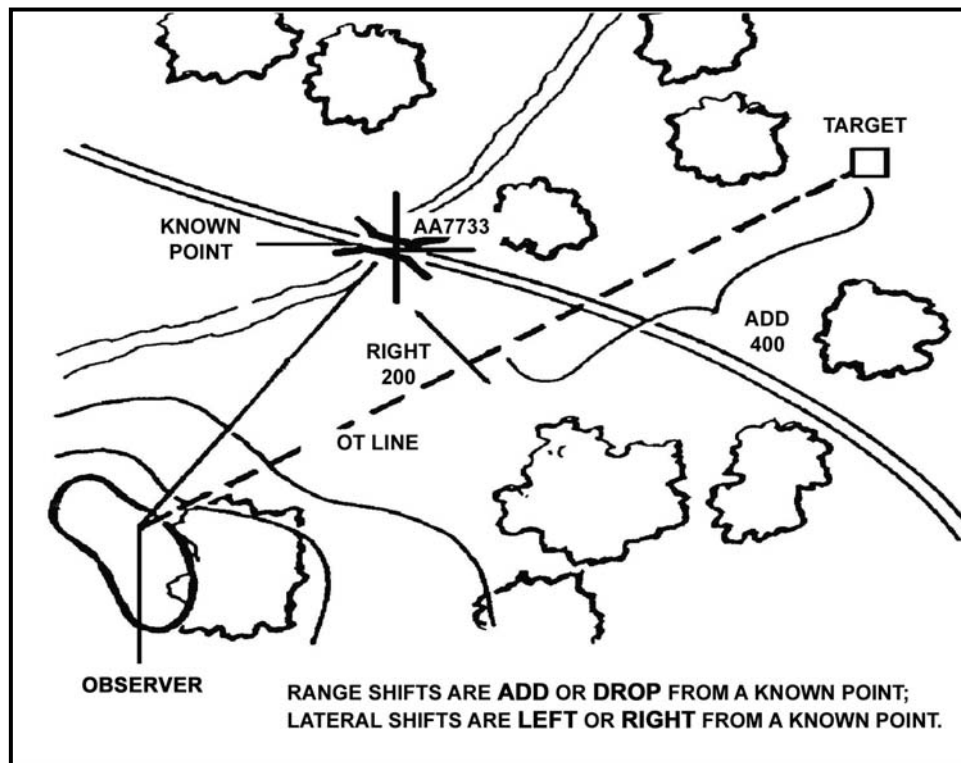

Figure 8-5. Lateral and range shifts.

(3) **Target Description.** Give a brief description of the target using the acronym “SNAP”:

- Size/shape.
- Nature/nomenclature.
- Activity.
- Protection/posture.

b. **Optional Elements.** A call for fire might also include the following information:

(1) **Method of Engagement.** The method of engagement consists of danger-close (if applicable), distribution, ammunition, and trajectory.

(2) **Method of Fire and Control.**

- At My Command—fired at observer’s command; when ready—standard method of fire control.
- Cannot Observe—fire will not be observed.
- Time on Target—rounds land at specified time.
- Continuous Illumination—FDC determines when to fire.
- Coordinated Illumination—observer determines when to fire.
- Cease Loading—used when two or more rounds are in effect (causes loader to stop loading).
- Check Firing—temporary halt in firing.
- Continuous Fire—will continue to fire unless told to stop.
- Repeat—will repeat last mission.

(3) **Refinement and End of Mission.**

- Correct any adjustments.
- Record as target.
- Report battle damage assessment.

(4) **Danger-Close.** Danger-close information is included when applicable.

- FA and mortars—Danger-close target is within 600 meters of friendly troops.
- Naval gunfire—Danger-close target is within 750 meters when using 5-inch or smaller guns (1,000 meters for larger naval guns).
- Method of adjustment—During danger-close missions, the FO uses only the creeping method of adjustment (corrections of no more than 100 meters).

8-4. ADJUST FIRE

Once he calls for fire, the observer adjusts the fire onto the target. If he has accurately located the target, he requests fire for effect. If the observer cannot locate the target (because of deceptive terrain, lack of identifiable terrain features, poor visibility, or an inaccurate map), he adjusts the impact point of the rounds. One artillery piece or mortar adjusts fire. The observer chooses an adjusting point: for a destruction mission (precision fire), the target is the adjusting point; for an area target (area fire), the observer picks a well-defined adjusting point close to the center. The observer spots the first and each successive adjusting round, and he sends range and deviation corrections back to the FDC until rounds hit the target. The observer spots by relating the round's point of impact to the adjusting point. (See FM 6-30 for a more detailed discussion of adjusting mortar and artillery fire.)

a. **Deviation Spotting.** Deviation (left or right) spotting involves measuring the horizontal angle (in mils) between the burst and the adjusting point (Figure 8-6). A burst to the right (left) of the target is spotted as “(so many) mils right (left).” The observer uses an angle-measuring device to determine deviation. He might use the mil scale on his binoculars (Figure 8-7) or his fingers and hand (Figure 8-8).

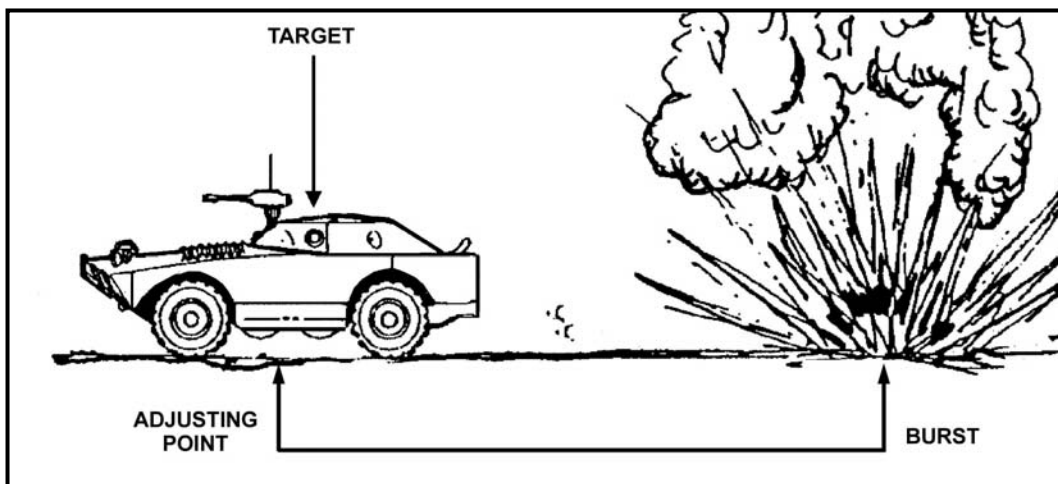

Figure 8-6. Deviation spotting.

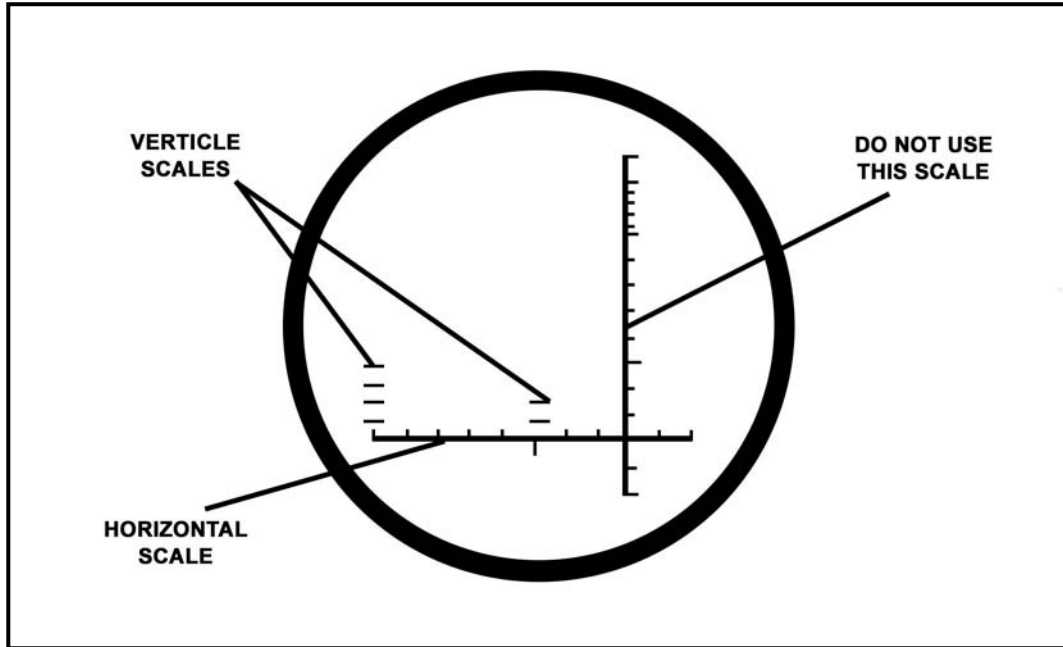

Figure 8-7. Mil scale on M17 binoculars.

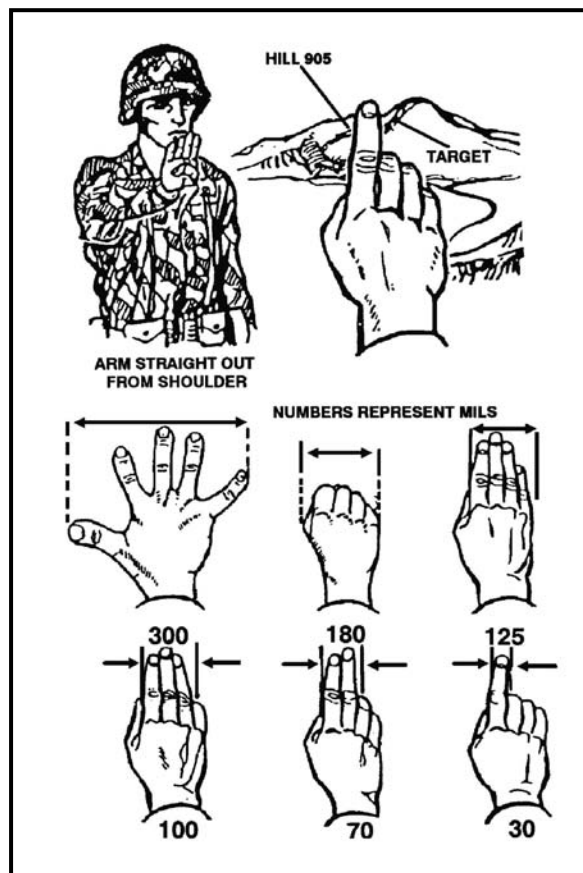

Figure 8-8. Hand and fingers used to determine deviation.

(1) On binoculars, the horizontal scale is divided into 10-mil increments and is used for measuring horizontal angles. The vertical scales in the center and on the left of the reticle are divided into 5-mil increments and are used for measuring vertical angles. The scale on the right, if present, is no longer used.

(2) A burst on the OT line is spotted as “line.” Deviation (left or right) should be measured to the nearest 5 mils for area targets, with measurements taken from the center of the burst. Deviation for a destruction mission (precision fire) is estimated to the nearest mil. (Figure 8-9 shows the adjusting point at the center of the binocular horizontal scale.)

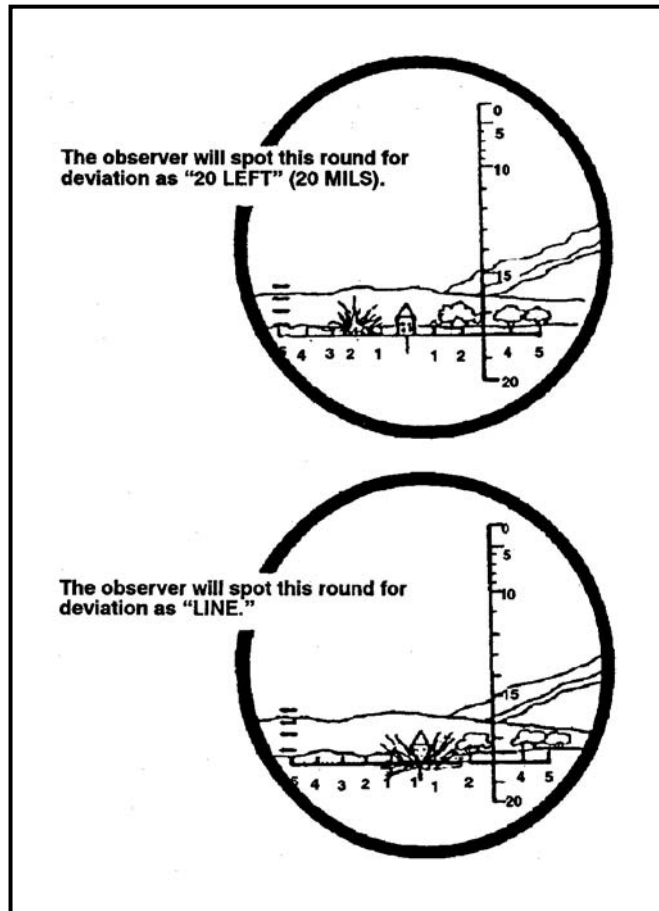

Figure 8-9. Deviation spotting with binoculars.

b. **Deviation Correction.** Deviation correction is the distance (in meters) the burst must be moved left or right to be on line between the observer and the target. Once the mil deviation has been determined, the observer converts it into a deviation correction (in meters). He sends it to the FDC either when sending the range correction for the next adjusting round or when calling for fire for effect. The deviation correction is determined by multiplying the observed deviation in mils by the distance from the observer to the target in thousands of meters (the OT factor). The result is expressed to the nearest 10 meters (see Example 1). A minor deviation correction (10 to 20 meters) should be made in adjustment of precision fire. In adjustment of area fire, small deviation corrections (20 meters or less) can be ignored except when a small change determines a definite range spotting. Throughout

the adjustment, the observer moves the adjusting rounds close enough to the OT line so that range spotting is accurate. If the OT distance is greater than 1,000 meters, round to the nearest thousand and express it in thousands of meters (Example 2). If the OT distance is less than 1,000 meters, round to nearest 100 meters and express it as a decimal in thousands of meters (Example 3).

EXAMPLE 1:

Observer deviation 20 mils

OT distance, 2,000 meters

OT factor 2

Observer deviation x OT factor = deviation correction.

$20 \times 2 = 40$ meters

EXAMPLE 2:

OT distance, 4,200 meters—OT factor, 4.0

OT distance, 2,700 meters—OT factor, 3.0

EXAMPLE 3:

OT distance, 800 meters—OT factor, 0.8

c. **Angle T.** Angle T (Figure 8-10) is the angle formed by the intersection of the gun-target line and the OT line with its vertex at the target. If angle T is 500 mils or greater, the FDC should tell the observer. If this occurs, the observer first continues to use the OT factor to make his deviation corrections. If he sees that he is getting more of a correction than he has asked for, the observer should consider cutting the corrections to better adjust rounds onto the target.

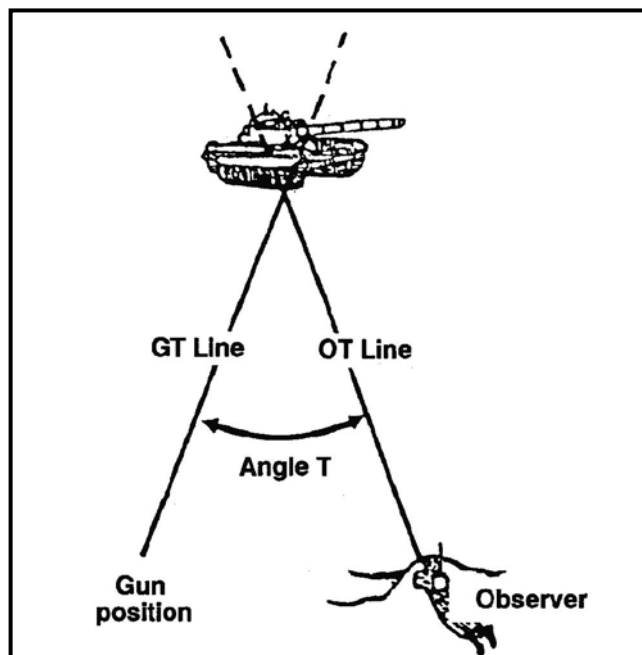

Figure 8-10. Angle T.

d. **Range Spotting.** Range spotting (short or over) requires adjusting the range to obtain fire on the target. An adjusting round's burst on or near the OT line gives a definite range

spotting. If he cannot make a definite spotting, the observer announces a “lost” or “doubtful” spotting. In these situations only, he gives the deviation correction to the FDC.

- (1) **“Over.”** The observer sees the burst beyond the adjusting point.
- (2) **“Short.”** The observer sees the burst between himself and the adjusting point.
- (3) **“Target.”** The observer sees the burst hit the target. He uses this spotting only in precision fire (destruction missions).
- (4) **“Range Correct.”** The observer believes that the burst occurred at the correct range.

(5) **“Doubtful.”** The observer sees the burst but cannot tell whether it occurred over, short, target, or range correct.

(6) **“Lost, Over” or “Lost, Short.”** The observer cannot see the burst, but he knows that it occurred beyond or short of the adjusting point.

e. **Range Correction.** With each successive correction, the *adjusting round* lands over or short of the *adjusting point*, but closes on the target.

(1) **Bracketing.** Bracketing brings fire on a target. Time is important, especially while targets move or seek cover from fire. Accuracy of data and speed of adjustments determine the effectiveness of the fire. To reduce adjustment time, the observer tries to bracket the target with the first two or three adjusting rounds.

(2) **Successive Bracketing.** The observer calls FFE when a range correction brings the round within 50 meters of the adjusting point. He also calls FFE when the firer splits a 100-meter bracket; for example, “Drop 50, fire for effect.” This technique is called successive bracketing (Figure 8-11). When bracketing, the observer uses the following guide to determine his first range correction.

- OT between 1,000 to 2,000 meters—add or drop at least 200 meters.
- OT greater than 2,000 meters—add or drop at least 400 meters.

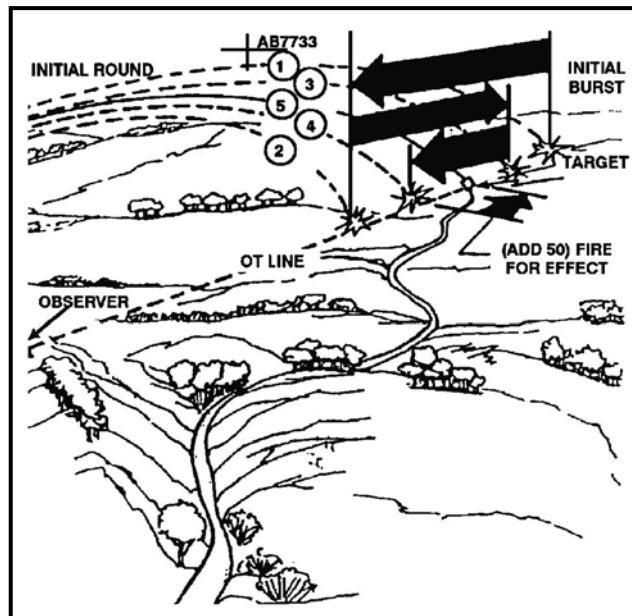

Figure 8-11. Successive bracketing technique.

(3) **Hasty Bracketing.** The effect on the target decreases as the number of rounds used in adjustment increases. Successive bracketing ensures that FFE rounds hit within 50 meters of the adjusting point. Hasty bracketing offers a quicker alternative to successive bracketing. A successful hasty bracket depends on a thorough terrain analysis, which gives the observer an accurate initial target location. For his first correction, the observer receives a bracket similar to that used for successive bracketing. Once the observer receives the initial bracket, he uses it like a yardstick to determine the subsequent correction. He then sends the FDC the correction to move the rounds to the target and to fire for effect (Figure 8-12). Hasty bracketing improves with observer experience and judgment.

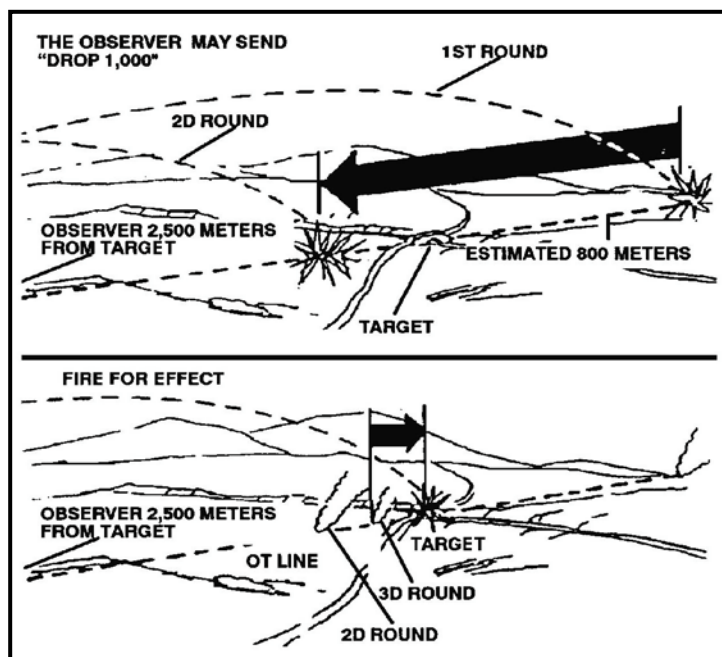

Figure 8-12. Hasty bracketing technique.

(4) **Creeping Method.** In danger-close situations, the observer uses the creeping method of adjustment. The observer calls for the first round, deliberately overshooting the target. He adjusts rounds in 100-meter increments or less until the fire hits the target (Figure 8-13, page 8-12). This method requires more time and ammunition than other methods; therefore, the observer uses it only when he must consider safety first.

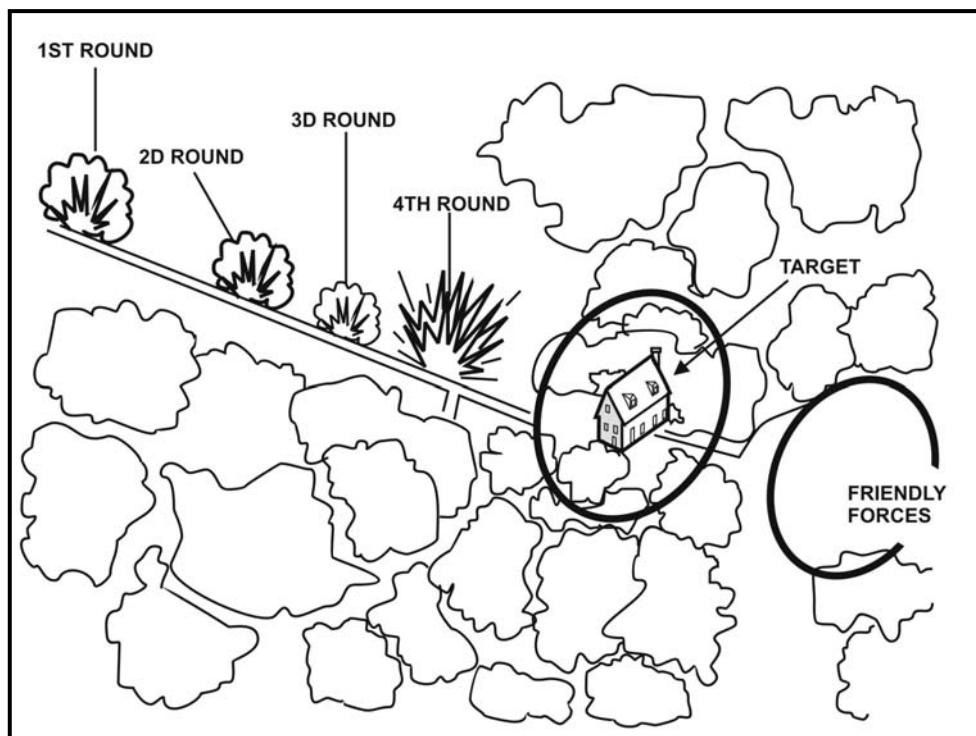

Figure 8-13. Creeping method of adjustment.

8-5. MORTAR SUPPORT

The task force mortar platoon has four mortars, which fire 120-mm rounds. The mortar platoon provides immediate indirect-fire support. Using mortars, the platoon can quickly place a heavy volume of accurate, sustained fire on the threat. Mortar rounds can strike targets that low-angle fires cannot reach. These include targets on reverse slopes, in narrow ravines or trenches, and in forests or towns, among others. The maximum effective range for the 120-mm mortar is 7,200 meters

a. **Types of Mortar Support.** Mortars provide the following types of effective support.

(1) **Suppression.** The platoon can fire HE rounds to force the threat to button up or move to less advantageous positions. Only a direct hit, however, will destroy an armored vehicle.

(2) **Smoke.** The platoon uses WP rounds for obscuration and screening. Mortar smoke builds up more rapidly than artillery smoke. To obscure the threat's vision, the platoon places smoke on or just in front of his positions. Placing smoke between the threat and the platoon's position conceals platoon movement. Mortar smoke marks threat positions to aid in friendly maneuver and orient direct fires. Scouts must be careful, however, not to allow smoke to work against them by marking their own positions for threat gunners.

(3) **Illumination.** The platoon uses illumination rounds to light an area or threat position during periods of limited visibility. Illumination increases the effectiveness of image-intensification devices, which helps with gathering information, adjusting artillery, and engaging threat targets. The platoon also uses ground-burst illumination to mark threat positions and to provide a thermal TRP for control of fires. The platoon must use illumination carefully so as not to illuminate friendly positions. Because U.S. night vision devices work better than those of most potential adversaries, the platoon may not need to

illuminate the battlefield at all. Doing so could cause more harm than good by revealing friendly positions.

b. **Capabilities and Limitations.** The advantages of using the mortar platoon include its close working relationship with BFV platoons, fast response time, and availability for low-density targets. The limitations of the platoon are—

- Short-range capability only.
- Few types of ammunition available.
- Mortar elements can carry only limited amounts of ammunition.
- FDC and mortar tubes unlinkable to advanced field artillery tactical data system (AFATDS).

8-6. FIELD ARTILLERY SUPPORT

The BFV platoon must know how to use artillery support to its best advantage. Artillery often offers the best way to impede and disrupt threat formations and suppress threat positions. It can provide immediate, responsive, and accurate fires with a wide variety of munitions. An artillery task force in direct support of a committed maneuver brigade provides field artillery support. The reconnaissance platoon might receive FA priority of fire.

a. **Capabilities.** In support of the platoon, FA elements can—

- Provide fires in all weather conditions and types of terrain.
- Shift and mass fires rapidly.
- Support the battle in depth with long-range fires.
- Provide a variety of conventional shell and fuze combinations.
- Provide continuous fires by careful positioning and timely displacement.

b. **Limitations.** FA support has the following limitations:

- Limited capability against moving targets.
- Might require large amounts of ammunition to destroy point targets.
- Firing signature makes it vulnerable to detection.

c. **Munitions.** FA employs a wide variety of munitions that the platoon can tailor to engage different types of targets.

(1) **High-Explosive.** The best targets for HE rounds include personnel, field fortifications, and vehicles.

(2) **Smoke.** The best uses for smoke include obscuring and screening friendly soldiers.

(3) **Illumination.** Ideally, these illuminate only the threat, not friendly forces.

(4) **White Phosphorus.** This volatile material effectively obscures friendly soldiers or actions, marks locations, and burns obstacles and equipment.

(5) **Cannon-Launched Guided Projectiles.** These projectiles (Copperheads) work best against point targets.

(6) **Improved Conventional Munitions.** Improved conventional munitions (ICM) work best against personnel targets.

(7) **Dual-Purpose Improved Conventional Munitions.** These munitions (DPICM) work best against personnel and light armored vehicles in the open.

(8) **Scatterable Mines.** These include *area denial munitions* for use against personnel and *remote antiarmor mines* for use against armored vehicles. An FA battery cannot mix other fire missions with scatterable mine missions. Scatterable mines require slightly more lead time than other FA-delivered munitions.

NOTE: The commander or leader must consider the danger to friendly troops in areas where friendly forces fire AP munitions. The potential dud rate of ICM makes maneuver in the area of an ICM field hazardous.

8-7. FIRE DIRECTION ASSETS

The FIST is attached to company teams for combat operations. The task force might push it forward with the BFV platoon to support security operations when special munitions engagements require on-target designation. The FIST's command-and-control link with the artillery makes it a valuable resource. The FIST should be exposed to fire only when no alternative exists.

- a. The FIST is organized, equipped, and trained to provide a fire support advisor and coordinator. It also provides a communications link to all available fire support assets.
- b. The company team FIST normally monitors the following radio nets:
 - Attached unit command net (task force, company team, or BFV platoon).
 - Task force mortar fire direction net.
 - DS battalion fire direction net (digital).
 - Battalion fire support net (voice).

8-8. FIRE REQUEST CHANNELS

The FSE serves as the NCS on the task force fire support net. The FIST relays the call for fire to supporting artillery on a digital net (AFATDS) or sends the fire mission to the mortar platoon or section. The command net allows the FIST to monitor unit operations. It links the FIST to the commander and platoon leaders for planning and coordination.

- a. **Mortar Requests.** The platoon can send requests for mortar fire directly to the mortars on the battalion heavy mortar net. The FSE monitors these requests (Figure 8-14).
- b. **Artillery Requests.** The platoon can send requests for artillery fire directly to the FA battalion on a fire direction net; the FSE monitors the requests (Figure 8-15).

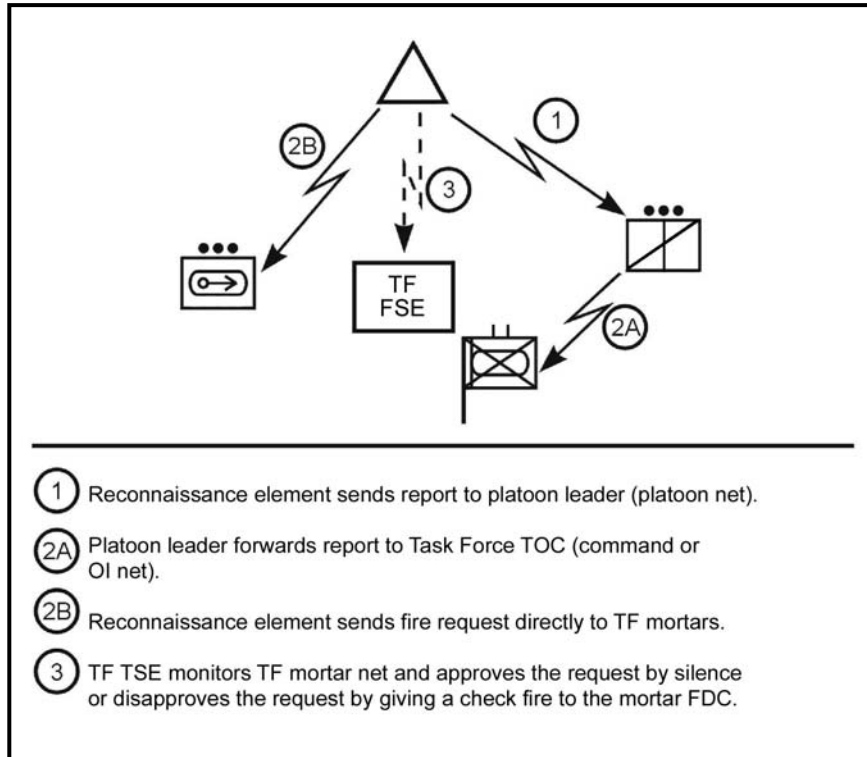

Figure 8-14. Platoon requesting fire from task force mortars.

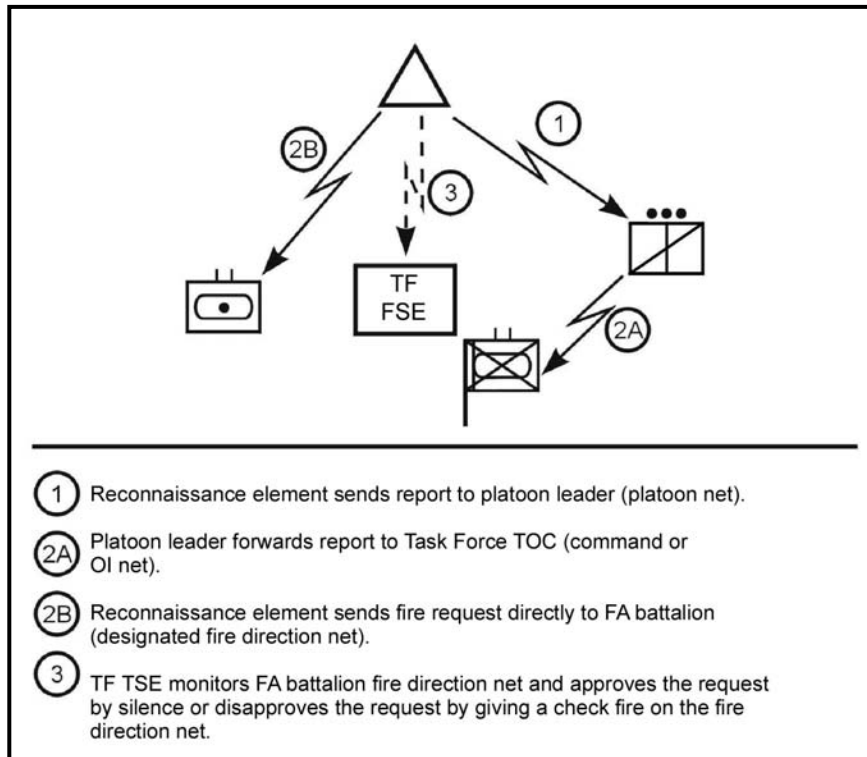

Figure 8-15. Platoon requesting fire from FA battalion.

8-9. CLOSE AIR SUPPORT

All services can provide CAS to the task force. CAS missions are flown against hostile targets near friendly forces. The forward air controller (FAC) is the task force commander's expert in planning, requesting, and executing CAS missions. The FAC serves as a link between the maneuver element and the attacking aircraft. The platoon may provide information the FAC or TACP uses to target enemy forces. Soldiers may provide emergency control if an FAC, FSO, or FO is not available (the task force commander accepts responsibility for friendly casualties). This is possible only with aircraft equipped with FM radios. Most U.S. Air Force, Navy, and Marine Corps fixed-wing aircraft only have UHF radios (A/OA-10, F16, AV-8B, F-14, F/A-18, and AC-130). (For additional information, see FM 6-30.) The platoon may also provide information on battle damage as observed. Figure 8-16 shows the format for assessing and reporting battle damage.

- Battle damage assessment.
- Successful or unsuccessful.
- Target coordinates.
- Time on target.
- Number and type destroyed.
- Number and type damaged.
- Killed by air.
- Wounded by air.
- Dud bombs.

Figure 8-16. Format for battle damage assessment.

a. **AC-130 Gunship.** If the threat air defense is low, the battalion requests CAS from an AC-130 gunship. The AC-130 provides effective fires during day and night operations and flies CAS and special operations. The aircraft contains one 40-mm gun, two 20-mm guns, two 7.62-mm miniguns, and one 105-mm howitzer. It is equipped with sensors and target acquisition systems that include forward-looking infrared radar and low-light television.

b. **Marking Friendly Positions.** Whenever possible, friendly positions are marked to enhance safety and to provide target area references. Methods of marking friendly positions are shown in Table 8-2.

METHOD	DAY/ NIGHT	ASSETS	FRIENDLY MARKS	TARGET MARKS	REMARKS
SMOKE	D/N	ALL	GOOD	GOOD	Easily identifiable, may compromise friendly position, obscure target, or warn of fire support employment. Placement may be difficult due to structures.
SMOKE (IR)	D/N	ALL/ NVD AT NIGHT	GOOD	GOOD	Easily identifiable, may compromise friendly position, obscure target, or warn of fire support employment. Placement may be difficult due to structures. Night marking is greatly enhanced by the use of IR reflective smoke
ILLUM, GROUND BURST	D/N	ALL	N/A	GOOD	Easily identified, may wash out NVDs.
SIGNAL MIRROR	D	ALL	GOOD	N/A	Avoids compromise of friendly location. Dependent on weather and available light and may be lost in reflections from other reflective surfaces (windshields, windows, water, etc.)
SPOT LIGHT	N	ALL	GOOD	MARGINAL	Highly visible to all. Compromises friendly position and warns of fire support employment. Effectiveness is dependent upon degree of urban lighting.
IR SPOT LIGHT	N	ALL NVD	GOOD	MARGINAL	Visible to all with NVGs. Less likely to compromise than overt light. Effectiveness dependent upon degree of urban lighting.
IR LASER POINTER (below .4 watts)	N	ALL NVG	GOOD	MARGINAL	Effectiveness dependent upon degree of urban lighting.
IR LASER POINTER (above .4 watts)	N	ALL NVD	GOOD	GOOD	Less affected by ambient light and weather conditions. Highly effective under all but the most highly lit or worst weather conditions. IZLID-2 is the current example.
VISUAL LASER	N	ALL	GOOD	MARGINAL	Highly visible to all. Risk of compromise is high Effectiveness dependant upon degree of urban lighting.
LASER DESIG- NATOR	D/N	PGM OR LST EQUIPED	N/A	GOOD	Highly effective with PGM. Very restrictive laser acquisition cone and requires line of sight to target. May require pre-coordination of laser codes
TRACERS	D/N	ALL	N/A	MARGINAL	May compromise position. May be difficult to distinguish mark from other gunfire. During daytime use, may be more effective to kick up dust surrounding target.
ELEC- TRONIC BEACON	D/N	SEE REMARKS	EXCELLENT	GOOD	Ideal friendly marking device for AC-130 and some USAF fixed wing (not compatible with Navy or Marine aircraft). Least impeded by urban terrain. Can be used as a TRP for target identification. Coordination with aircrews essential to ensure equipment and training compatibility.
STROBE (OVERT)	N	ALL	MARGINAL	N/A	Visible by all. Effectiveness dependent upon degree of urban lighting.
STROBE (IR)	N	ALL NVD	GOOD	N/A	Visible to all NVDs. Effectiveness dependent upon degree of urban lighting. Coded strobes aid in acquisition

Table 8-2. Methods of marking friendly positions.

METHOD	DAY/ NIGHT	ASSETS	FRIENDLY MARKS	TARGET MARKS	REMARKS
FLARE (OVERT)	D/N	ALL	GOOD	N/A	Visible by all. Easily identified by aircrew.
FLARE (IR)	N	ALL NVD	GOOD	N/A	Visible to all NVDs. Easily identified by aircrew.
GLINT/IR PANEL	N	ALL NVD	GOOD	N/A	Not readily detectable by enemy. Very effective except in highly lit areas.
COMBAT IDENTIFICATION PANEL	D/N	ALL FLIR	GOOD	N/A	Provides temperature contrast on vehicles or building. May be obscured by urban terrain.
VS-17 PANEL	D	ALL	MARGINAL	N/A	Only visible during daylight. Easily obscured by structures.
CHEMICAL HEAT SOURCES	D/N	ALL FLIR	POOR	N/A	Easily masked by urban structures and lost in thermal clutter. Difficult to acquire, can be effective when used to contrast cold background or when a/c knows general location.
SPINNING CHEM-LIGHT (OVERT)	N	ALL	MARGINAL	N/A	Provides unique signature. May be obscured by structures. Provides a distinct signature easily recognized. Effectiveness dependent upon degree of urban lighting.
SPINNING CHEM-LIGHT (IR)	N	ALL NVD	MARGINAL	N/A	Provides unique signature. May be obscured by structures. Effectiveness dependent upon degree of urban lighting.

Table 8-2. Methods of marking friendly positions (continued).

8-10. ATTACK HELICOPTERS

The primary mission of attack helicopter units is to destroy armor and mechanized forces. Employing attack helicopters in combined arms operations increases the lethality of ground maneuver forces.

a. **Aircraft Characteristics.** The AH-64A Apache, the AH-64D Longbow Apache, the OH-58D Kiowa Warrior, and the AH-1W or AH-1Z (USMC) are employed in attack operations. Table 8-3 provides a comparison of the weapon systems and armaments on these attack helicopters. (The table also lists weaponry for the AH-1 Cobra, which is no longer in the active Army inventory but might be used to provide attack support in joint operations with U.S. Marine units.)

AIRCRAFT TYPE	WEAPON SYSTEMS						
	Hellfire/TOW ¹		Air-to-Air Stinger	2.75-inch (70-mm) Rockets	Cal .50 MG (rds)	20-mm Cannon (rds)	30-mm Chain Gun (rds)
AH-1 ²		8		76		750	
AH-64A ³	16			76			1,200
AH-64D ³	⁴ 16		4	76			1,200
OH-58D ^{2,3}	4		4	14	500		
AH-1W/Z ⁵							
Weapons Range (Max)	8 km	3,750 m	5+ km	8 km	2 km	2 km	4 km

Numbers in each column indicate the maximum load for each system.

¹ The AH-1 uses the TOW missile as its armor engagement weapon instead of the Hellfire missile.

² This aircraft carries one weapon system on each side (Hellfire, TOW, or both; air-to-air Stinger; and 2.75-inch rocket).

³ Aircraft has a laser for target designation and an ATHS.

⁴ Hellfire/Hellfire II.

⁵ USMC helicopters will have varied weapon loads. During coordination, request on-board weapon status.

Table 8-3. Helicopter weapon systems.

b. **Close Combat Attack.** The close combat attack does not replace the integrated MDMP between ground maneuver and aviation. It is a technique for directing lethal fires within the context of a replanned mission.

(1) To request immediate close combat attack, the ground unit in contact executes a face-to-face coordination or uses a radio transmission to provide a situation update to the attack aircraft (METT-TC permitting). This situation update contains essential elements from the aviation close combat attack coordination checklist (Figure 8-17, page 8-20).

(2) After receipt of a request for immediate close combat attack, the attack team leader then informs the ground unit leader of the battle position, attack-by-fire position, or the series of positions his team will occupy that will provide the best observation and fields of fire into the engagement or target area. The attack team leader then provides the ground maneuver unit leader with his concept for the team's attack on the objective.

(3) Upon mission completion, the attack team leader provides the ground maneuver commander a battle damage assessment (BDA) of the intended target.

CLOSE COMBAT ATTACK CHECKLIST	
1.	Threat situation—specific target identification.
2.	Friendly situation—location and method of marking friendly positions.
3.	Ground maneuver mission/scheme of maneuver.
4.	Attack aircraft scheme of maneuver.
5.	Planned engagement area and BP/SBF position.
6.	Method of target marking.
7.	Fire coordination and fire restrictions.
8.	Map graphics update.
9.	Request for immediate aviation close fight support—used for targets of opportunity or for ground-to-air target handoff.

Figure 8-17. Close combat attack coordination checklist.

Section II. COMBAT ENGINEER SUPPORT

Engineer missions fit into one of three categories: mobility, countermobility, and survivability. (Table 8-4 shows the tasks included in each of these categories.) An engineer platoon might be attached to a company team. Engineers conduct reconnaissance, evaluate obstacles, and use demolitions and field expedients.

MOBILITY	COUNTERMOBILITY	SURVIVABILITY
Breaching obstacles. Clearing minefields. Clearing routes. Expedient gap crossing. Constructing combat roads or trails.	Constructing obstacles to turn, fix, block, or disrupt threat forces.	Constructing crew-served weapons and vehicle fighting positions.

Table 8-4. Engineer missions.

8-11. ENGINEER ORGANIZATION

Typically an engineer company is attached to support a task force. The company consists of two engineer platoons and an assault and obstacle (A&O) platoon. The task force and company team commanders will task organize engineer assets to best accomplish their assigned mission.

a. **Engineer Platoon.** Each engineer platoon is organized into three engineer squads and a headquarters section. It is equipped with four M113 or M2A2ODS-E, engineer Bradley fighting vehicle (EBFV), and an armored combat earthmover (ACE). If necessary, the engineer platoon may be reinforced with elements from the engineer company’s A&O platoon.

b. **Assault and Obstacle Platoon.** The A&O platoon consists of two assault sections and an obstacle section. Each assault section has two armored-vehicle-launched bridges (AVLBs), two ACEs, and two mine-clearing line charges (MICLICs). The obstacle section has two M548s (which carry the Volcano mine-laying system), two small earth excavators (SEEs), two heavy expanded-mobility tactical trucks (HEMTTs), and one ACE.

8-12. MOBILITY

At the tactical level, overwatching mobility is critical to the success of the force. Engineers support infantry by performing obstacle reduction and route construction/improvement.

a. **Obstacle Reduction.** Reduction is the creation of lanes through or over an obstacle to allow an attacking force to pass. The number and width of lanes created varies with the factors of METT-TC. The lanes must allow the assault force to rapidly pass through the obstacle. The breach force will reduce, proof (if required), mark, and report lane locations and the lane marking method IAW unit SOP. Engineers cannot reduce an obstacle until the obstacle has been identified, effective suppression and obscuration are in place, and the point of breach is secure. (For detailed discussions of breaching see FM 3-34.2 and FM 71-1.)

b. **Route Construction and Improvement.** Engineers have a limited capability to construct, improve, and maintain roads, bridges, and fords. In addition to providing mobility support during offensive operations, engineers can enhance mobility during defensive operations by focusing on the ability to shift forces. Enhancements to mobility during defensive operations include:

- Mobility between primary, alternate and supplementary battle positions.
- Mobility of reserves to reinforcing positions.
- Mobility of reserves in the counterattack.

8-13. COUNTERMOBILITY

Engineers construct obstacles that prevent the enemy from successfully executing his scheme of maneuver. (For a detailed discussion of countermobility operations, see FM 71-1.) Commonly used obstacles include minefields, wire obstacles, antitank ditches, road craters, abatis, and log cribs. Engineers also can reinforce restrictive terrain and existing obstacles to disrupt, fix, turn, or block the enemy. Platoons will execute the company team commander's countermobility plan. Within this plan, the infantry rifle squads will typically assist engineers in the emplacement of obstacles. Regardless of the type of defense employed, the platoon leader must remember the five basic principles of obstacle employment.

- Obstacles must support the scheme of maneuver.
- Obstacles must be integrated with and covered by observed direct and indirect fires.
- Obstacles must tie into terrain and existing obstacles.
- Obstacles are most effect when complex and employed in depth.
- Obstacles should be employed to surprise the enemy.

8-14. SURVIVABILITY

The survivability plan will be synchronized with the company team countermobility plan. Platoons should prepare by marking vehicle positions, identifying leaders to supervise position construction, and designating guides for the blade movement between positions. Platoons will execute the company team commander's plan for priority of the survivability effort. This plan should specify the following:

- Level of survivability of each subordinate unit.
- Priority of survivability support by specific unit, type of weapon system, or combination.

- Type of position to be dug for a unit or type of weapon system.
- Sequence and time allocated for platoons to receive blade support.

Section III. AIR DEFENSE

Bradley Stinger fighting vehicle (BSFV), Linebacker, Avenger, or Stinger assets may support the BFV infantry platoon. Although the BFV platoon's role in air defense is limited to reporting threat aircraft, the platoon should practice passive and active air defense measures for protection against threat air attack.

8-15. ACTIVE AIR DEFENSE

The BFV platoon avoids engaging threat aircraft if possible. If engagement is unavoidable, the platoon uses a technique known as volume of fire (Figure 8-18). This technique is based on the premise that the more bullets a unit can put in the sky, the greater the chance the enemy will fly into them. Even if these fires do not hit the enemy, a "wall of lead" in the sky can intimidate enemy pilots, causing them to break off their attack, or can distract them from taking proper aim. One of the most important points about volume of fire is that, once the lead distance is estimated, the soldier must aim at the estimated aiming point and fire at that single point until the aircraft has flown past it. The soldier maintains the aiming point, not the lead distance. Once the soldier starts firing, he does not adjust his weapon. The platoon leader establishes the aiming point based on the type of aircraft that is attacking (Figure 8-19).

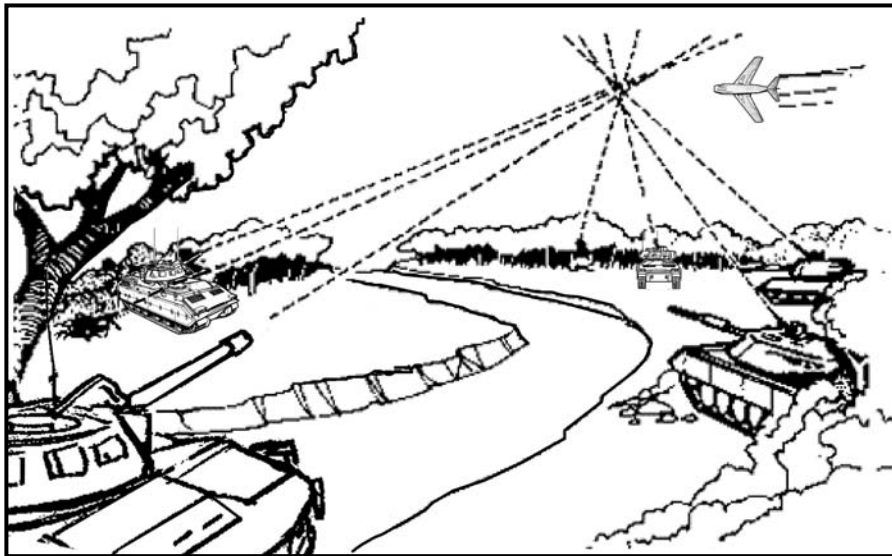

Figure 8-18. Volume of fire.

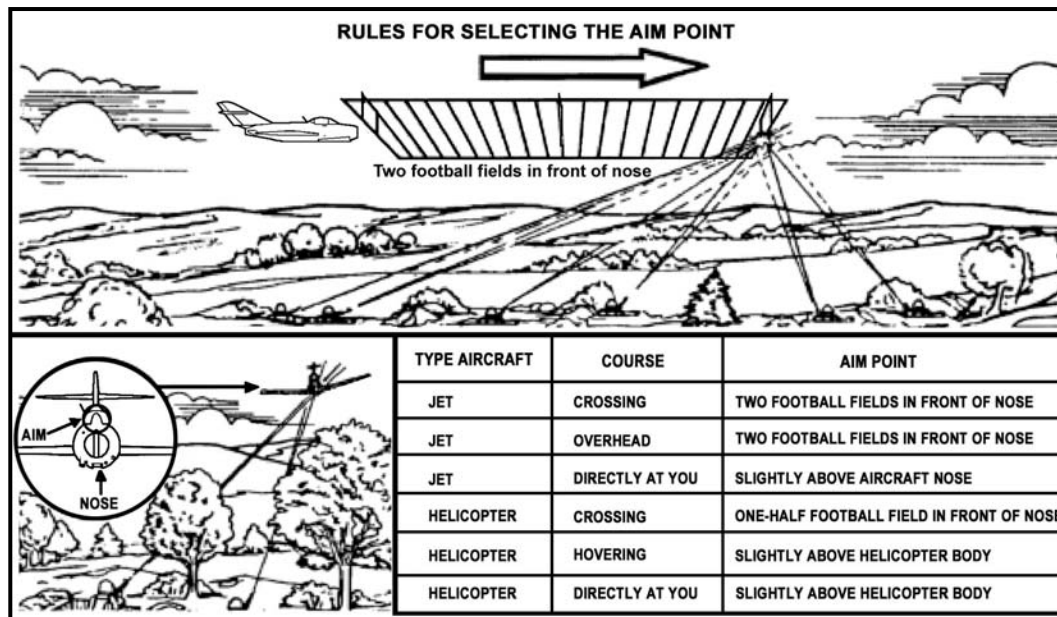

Figure 8-19. Aim points.

a. **Weapon Control Status.** Weapon control statuses describe the relative degree of control of air defense fires. Weapon control statuses apply to weapon systems, volumes of airspace, or types of air platforms. The degree or extent of control varies depending on the tactical situation. Establishment of separate weapon control statuses for fixed- and rotary-wing aircraft, unmanned aerial vehicles (UAVs), and missiles is normal.

(1) **Weapons Free.** Weapons can fire at any air target not positively identified as friendly. This is the least restrictive weapon control status.

(2) **Weapons Tight.** Fire only at air targets positively identified as hostile according to the prevailing hostile criteria. Positive identification can be effected by a number of means to include visual identification (aided or unaided) and meeting other designated hostile criteria supported by track correlation.

(3) **Weapons Hold.** Do not fire except in self-defense or in response to a formal order. This is the most restrictive weapon control status. The BFV platoon should always be in WEAPONS HOLD.

b. **Short-Range Air Defense Systems.** Although other short-range air defense (SHORAD) systems support divisional units, BFV platoons with dedicated ADA systems are most likely to be supported by the M6 Bradley Linebacker (Figure 8-20, page 8-24) or a man-portable air defense system (MANPADS). Stinger MANPADS (Figure 8-21, page 8-25) is designed to counter high-performance, low-level, ground attack aircraft; helicopters; and observation and transport aircraft.

(1) The Linebacker's combined arms mission is to provide protection to mechanized combat forces, combat support elements, and other critical assets from attack by enemy rotary-wing aircraft, fixed-wing aircraft, UAVs, and cruise missiles (CMs). The Linebacker provides the task forces with highly mobile dedicated air defense firepower. The Linebacker is equipped with the standard vehicle-mounted launcher (SVML), which carries four Stinger missiles and has the following capabilities.

- The modified fire control subsystem fires, and the SVML, allows the Linebacker to shoot on the move.
- The four-man squad remains under armor protection.
- Targeting data is provided by the forward area air defense (FAAD) command, control, communications, and intelligence (C3I).
- The Linebacker system allows shoot-on-the-move and slew-to-cue capability.
- In the event of launcher system damage or failure or static mode, the system maintains dismounted Stinger missile capability.
- The 25-mm chain gun contributes adjunct air defense firepower and, as with the 240C, the 7.62-mm coax machine gun provides self-defense.



Figure 8-20. M6 Bradley Linebacker.

(2) The Stinger missile system employs a two-man crew (crew chief and gunner). The MANPADS team normally has a BFV as its assigned transportation. Unit leaders must carefully consider the consequences before separating a Stinger team from its vehicle. Stinger teams operating away from their vehicles have no more than two missiles available for resupply.

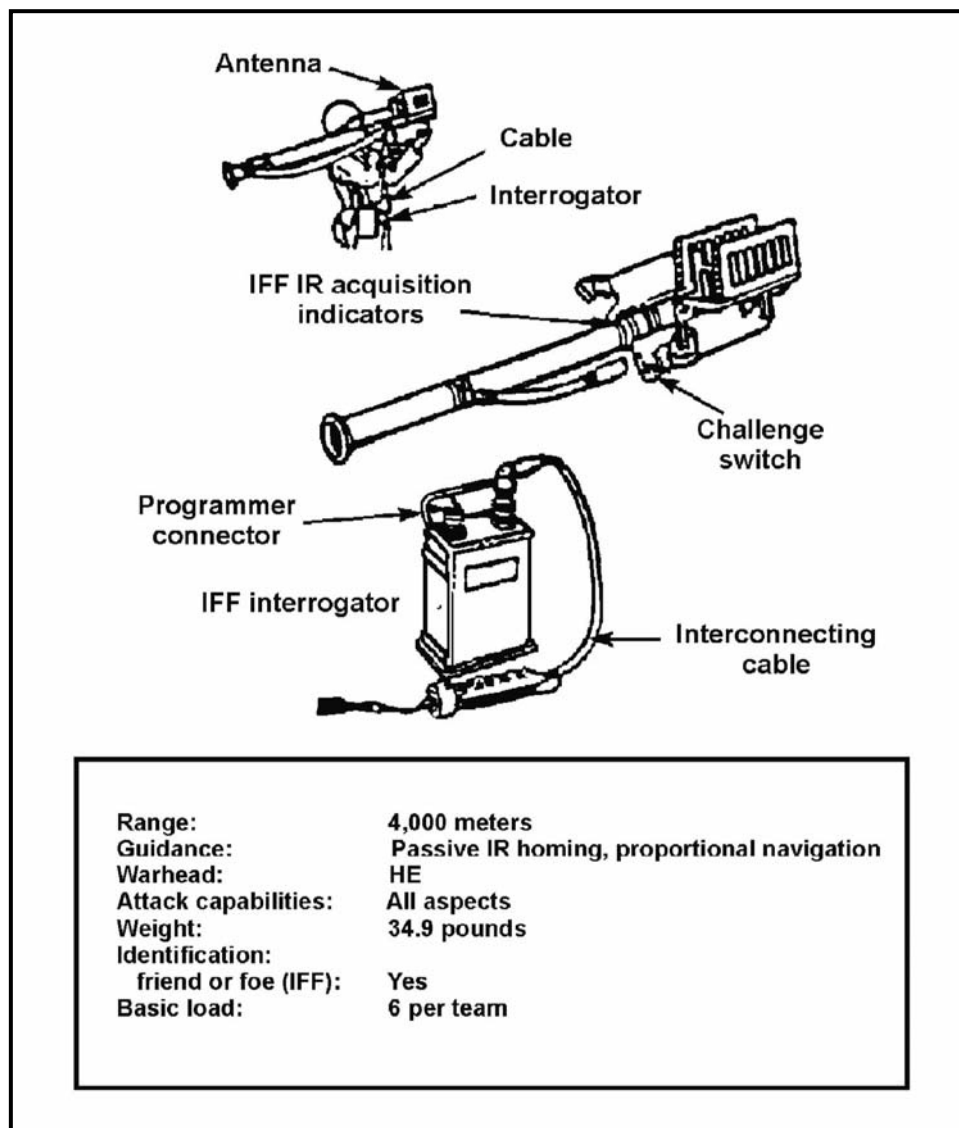

Figure 8-21. Stinger air defense system.

(3) If the brigade has an attached SHORAD battery, the BFV platoon will receive early warning alerts from the SHORAD battery and its elements. The SHORAD C3I Sentinel radar team can broadcast early warning of threat air activity to SHORAD elements (battery, platoon, or section), to FA fire units, and to air defense LNOs. The SHORAD battery will then provide voice early warning on the brigade command net. If METT-TC factors permit, the SHORAD platoon provides voice early warning to the task forces.

(4) The Sentinel radar (Figure 8-22, page 8-26) provides a 360-degree detection capability for various air tracks (rotary- and fixed-wing aircraft, UAVs, and cruise missiles) to a range of 40 kilometers. The Sentinel radar is normally OPCON to the respective SHORAD battery commander.

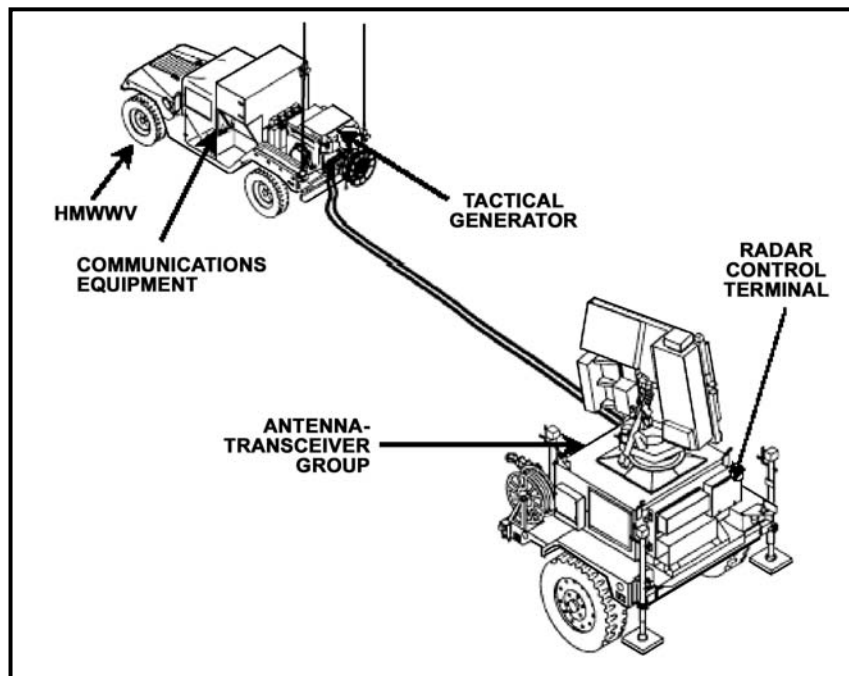

Figure 8-22. Sentinel radar system.

8-16. PASSIVE AIR DEFENSE

Passive air defense measures are all measures other than active defense taken to minimize the effects of the hostile air action. Passive defense measures are of two types: attack avoidance and damage-limiting. Both include the use of cover, concealment, camouflage, protective cover, and deception.

a. **Attack Avoidance Measures.** Attack avoidance means taking the actions necessary to avoid being seen by the threat. A threat pilot cannot attack what he cannot see. The techniques, procedures, and materials used for concealment from aerial observation are the same as those used for concealment from ground observation. The platoon should routinely practice and enforce hiding, blending, and disguising reflective equipment to avoid detection.

b. **Damage-Limiting Measures.** Damage-limiting measures are those taken to reduce the effects of a threat air attack. One of the best damage-limiting measures is the use of dispersion to lessen target density and reduce the lethal effects of the ordnance used against the platoon. When an attack is imminent, the platoon disperses, moves to concealed positions, and stops. These actions reduce the probability of being spotted and, if spotted, reduce the effects of threat munitions.

8-17. AIR DEFENSE WARNINGS

Air defense, passive or active, is more effective if the platoon knows beforehand that an air attack is imminent. The initial warning should come from the supporting ADA unit or higher headquarters. Air defense warnings come both from the OPORD and over radio command frequencies. RED indicates that an attack is imminent or in progress; YELLOW indicates that an attack is probable; and WHITE indicates that an attack is not likely.

CHAPTER 9

COMBAT SERVICE AND SUPPORT

In any military unit, CSS sustains the force during continuous combat operations. The platoon can deploy in the mounted and dismounted roles. In the BFV-equipped infantry platoon, the platoon leader is responsible for CSS; the platoon sergeant is the platoon's main CSS operator. The platoon sergeant works closely with the company team executive officer and first sergeant to ensure the platoon receives the required support for its assigned mission. CSS responsibilities and procedures in the platoon remain basically the same. The company normally forecasts supplies and "pushes" rather than "pulls" them to the platoon.

9-1. INDIVIDUAL RESPONSIBILITIES

This paragraph focuses on specific individual responsibilities within the platoon's CSS chain.

a. **Platoon Sergeant.** As the platoon's main CSS operator, the platoon sergeant executes the platoon's logistical plan, based on platoon and company SOPs. The platoon sergeant's CSS duties include:

(1) **Rehearsals.** He participates in CSS rehearsals at the company level and integrates CSS into the platoon's maneuver rehearsals.

(2) **Administrative, Personnel, and Casualty Reports.** He receives, consolidates, and forwards all administrative, personnel, and casualty reports to the first sergeant as directed or in accordance with unit SOP.

(3) **Pickup and Distribution.** He obtains supplies, equipment (except Class VIII), and mail from the supply sergeant, and then he ensures proper distribution.

(4) **Evacuation.** He supervises evacuation of casualties, EPWs, and damaged equipment.

(5) **Manning Roster.** He maintains the platoon's manning roster.

b. **Squad and Section Leader.** Each squad and section leader's CSS duties include:

(1) **Maintenance.** He ensures crews perform proper maintenance on all assigned equipment.

(2) **Personnel and Logistics Reports.** He compiles personnel and logistics reports for the platoon and submits them to the platoon sergeant as directed or IAW unit SOP.

(3) **Pickup and Distribution.** He obtains supplies, equipment (all classes), and mail from the platoon sergeant and ensures proper distribution.

9-2. PLANNING CONSIDERATIONS

Planning CSS operations is primarily a company and battalion-level operation. While the company commander and executive officer plan the operation, the platoon leader is responsible for his platoon's execution of the plan at squad and vehicle level, and the platoon sergeant executes the plan at platoon level.

a. **Development of the CSS Plan.** The platoon leader develops his CSS plan by determining exactly what he has on hand to accurately predict his support requirements. This process is important not only in confirming the validity of the CSS plan but also in ensuring the platoon submits support requests as early as possible. The platoon leader

formulates his CSS execution plan and submits support requests to the company, based on his maneuver plan.

b. **Operational Questions.** The CSS plan should provide answers to operational questions such as the following:

(1) **Types of Support.** Based on the nature of the operation and specific tactical factors, what types of support will the platoon need?

(2) **Quantities.** In what quantities will this support be required?

(a) Will emergency resupply be required during the battle?

(b) Does this operation require prestock supplies?

(3) **Threat.** What are the composition, disposition, and capabilities of the expected enemy threat? How will these affect CSS operations during the battle?

(a) Where and when will the expected contact occur?

(b) What are the platoon's expected casualties and vehicle losses based on the nature and location of expected contact?

(c) What impact will the enemy's special weapons capabilities (such as NBC) have on the battle and on expected CSS requirements?

(d) How many EPWs are expected, and where?

(4) **Terrain and Weather.** How will terrain and weather affect CSS operations during the battle?

(a) What ground will provide the best security for maintenance and CCPs?

(b) What are the platoon's vehicle and casualty evacuation routes?

(c) What are the company's dirty routes for evacuating contaminated personnel, vehicles, and equipment?

(5) **Time and Location.** When and where will the platoon need CSS?

(a) Based on the nature and location of expected contact, what are the best sites for the CCP?

(b) Where will the EPW collection points be located?

(6) **Requirements.** What are the support requirements, by element and type of support?

(a) Which section has priority for emergency Class III resupply?

(b) Which section or squad has priority for emergency Class V resupply?

(7) **Risk Factor.** Will lulls in the battle permit support elements to conduct resupply operations in relative safety? If no lulls are expected, how can the platoon best minimize the danger to the CSS vehicles providing the required support?

(8) **Resupply Technique.** Based on information developed during the CSS planning process, which resupply technique should the platoon use?

c. **Classes of Supply Considerations.** The platoon sergeant obtains supplies and delivers them to the platoon. The platoon leader establishes priorities for delivery, but combat demands that Class I, III, V, and IX supplies and equipment take priority, because they are the most critical to successful operations.

(1) **Class I.** This class includes rations, water, and ice. It also includes gratuitous issue of items related to health, morale, and welfare. The Daily Strength Report triggers an automatic request for Class I supplies. Personnel in the field trains prepare rations and deliver them with the logistics package (LOGPAC). During the initial deployment, soldiers eat meals-ready-to-eat (MREs) stored on combat vehicles. Due to the probability

of long lines of communication (LOC) and resupply, the platoon must keep a three-day supply of rations on hand for each soldier at all times.

(2) **Class II.** This class includes clothing, individual equipment, mission-oriented protective posture (MOPP) suits, tentage, tool sets, and administrative and housekeeping supplies and equipment. The platoon sergeant distributes expendable items such as soap, toilet tissue, and insecticide during LOGPAC operations.

(3) **Class III.** This class includes POL products. Unusual Class III requests go to the first sergeant and then to the task force combat trains.

(a) POL includes both bulk and packaged products. Examples of bulk products include JP8 (Army common fuel), diesel fuel, and motor gasoline (MOGAS).

(b) Platoon requests and receives Class III products such as 5-gallon and 55-gallon containers, lubricants, grease, hydraulic fluid, cylinders of liquid and compressed gasses, and solvents in amounts of 55 gallons or less.

(4) **Class IV.** This class includes construction materials, pickets, sandbags, and concertina wire.

(5) **Class V.** This class covers all types of ammunition and mines, including C4 and other explosives.

(6) **Class VI.** This class includes personal-demand items normally sold through the exchange system, which can include candy, soaps, cameras, and film.

(7) **Class VII.** This class includes major end items such as tanks, BFVs, and other vehicles. Battle loss reports trigger the issuance of Class VII items. Ready-to-fight weapons systems go forward with the LOGPAC.

(8) **Class VIII.** This class covers medical material, including repair parts peculiar to medical equipment and management of blood. The battalion aid station (BAS) resupplies combat lifesaver bags and restocks first-aid kits.

(9) **Class IX.** This class includes repair parts and documents required for equipment maintenance operations. Repair parts are issued in response to a specific request or are obtained by direct exchange of repairable parts. The latter can include batteries for NVDs and man-portable radios. In combat situations, exchange and cannibalization are normal ways to obtain Class IX items.

(10) **Class X.** This class includes materials to support nonmilitary programs such as agricultural and economic development. Division level or higher will provide the platoon with instructions for requesting and issuing Class X supplies.

9-3. RESUPPLY OPERATIONS

Resupply operations fall into one of three classifications: routine, emergency, or prestock. The platoon SOP specifies cues and procedures for each method. The platoon rehearses resupply operations during platoon training exercises. The actual method selected for resupply in the field depends on METT-TC factors.

a. **Routine Resupply.** Routine resupply operations cover items in Classes I, III, V, and IX; mail; and other items requested by the platoon. When possible, the platoon should conduct routine resupply daily. Ideally, it does so during periods of limited visibility. BFVs and other large combat vehicles use large amounts of fuel, so the platoon must resupply Class III at every opportunity.

(1) The LOGPAC technique offers a simple, efficient way to accomplish routine resupply operations. The key feature, a centrally organized resupply convoy, originates at

the task force trains. The convoy carries all items needed to sustain the platoon for a specific period (usually 24 hours) or until the next scheduled LOGPAC. The task force SOP will specify the LOGPAC's exact composition and march order.

(2) As directed by the commander or XO, the first sergeant establishes the company resupply point. He uses either the service station or tailgate method. He briefs each LOGPAC driver on which method to use. When he has the resupply point ready, the first sergeant informs the commander. The company commander then directs each platoon or element to conduct resupply based on the tactical situation.

(a) The service station (Figure 9-1) method allows vehicles with their squads to move individually, or in small groups, to a centrally located resupply point. Depending on the tactical situation, a vehicle, section, or platoon moves out of its position, conducts resupply operations, and moves back into position. This process continues until the entire platoon has received its supplies. In using this method, vehicles enter the resupply point following a one-way traffic flow. Only vehicles that require immediate maintenance stop at the maintenance holding area. Vehicles move through each supply location. The crews rotate individually to eat, pick up mail and sundries, and refill or exchange water cans. When all platoon vehicles and crews have completed resupply, they move to a holding area. There, time permitting, the platoon leader and the platoon sergeant conduct a precombat inspection (PCI).

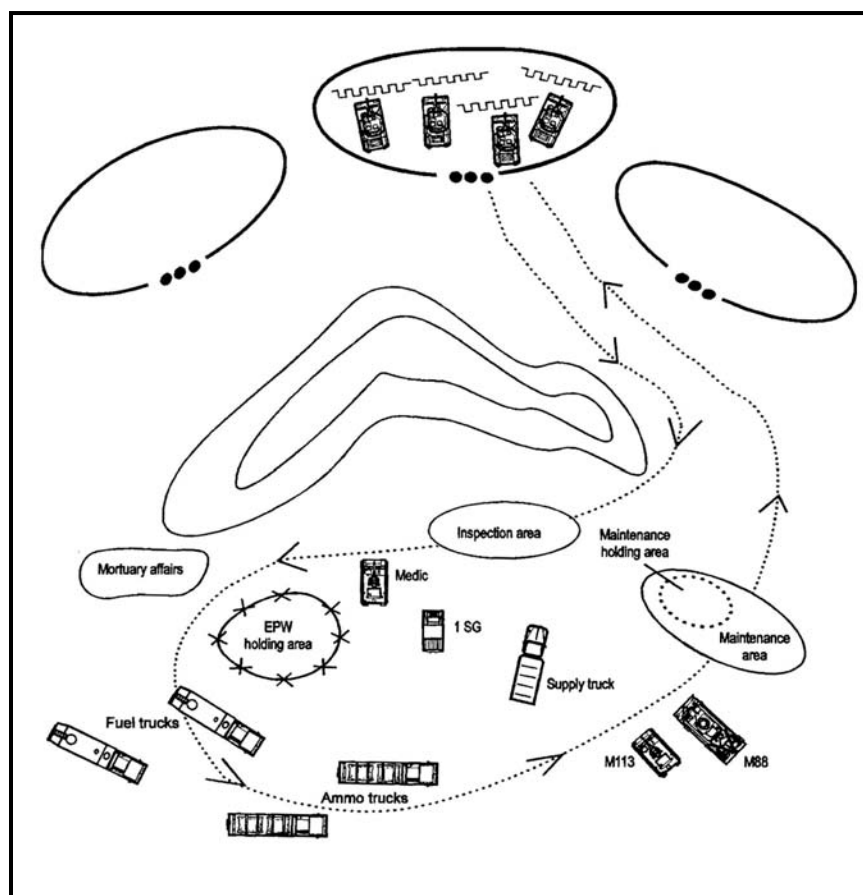

Figure 9-1. Service station method.

(b) In assembly areas, the first sergeant normally uses the tailgate method (Figure 9-2). Combat vehicles remain in their vehicle positions, or they back out a short distance to allow trucks carrying Class III and V supplies to reach them. Individual soldiers rotate through the feeding area. While there, they pick up mail and sundries, and refill or exchange water cans. They centralize and guard any EPW. They take soldiers killed in action (KIA) and their personal effects to the holding area, where the first sergeant assumes responsibility for them.

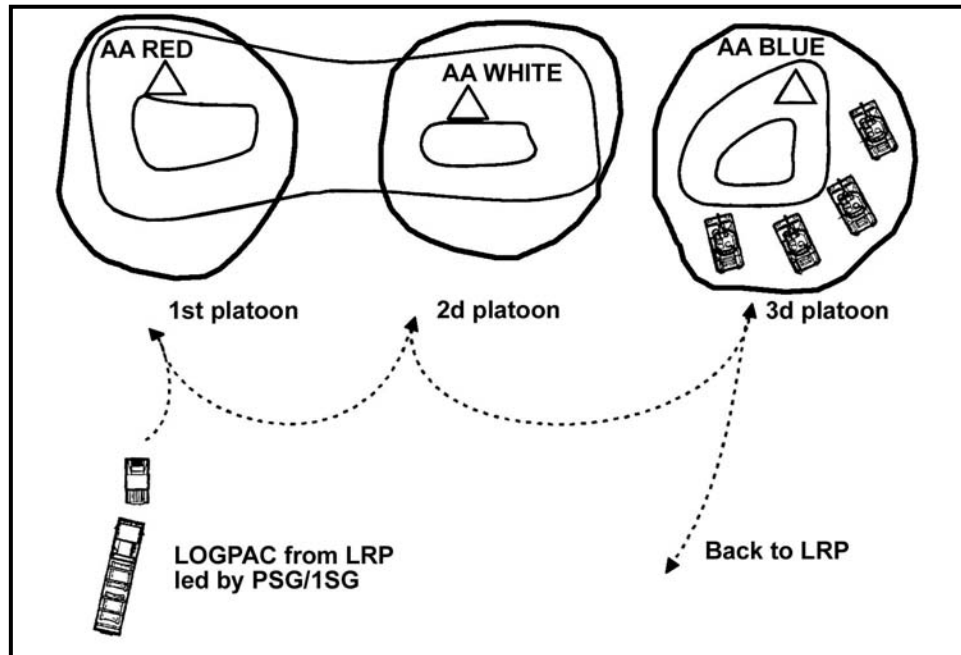

Figure 9-2. Tailgate method.

b. **Emergency Resupply.** Occasionally (normally during combat operations), the platoon might have such an urgent need for resupply that it cannot wait for a routine LOGPAC. Emergency resupply could involve NBC equipment as well as Classes III, V, VIII, and water.

c. **Prestock Resupply.** In defensive operations, and at some other times, as appropriate, the platoon will most likely need restocked supplies, also known as pre-positioned or “cached” resupply. Normally, the platoon only pre-positions Class IV and V items, but they can also pre-position Class III supplies. However, they must refuel platoon vehicles before they move into fighting positions, while first occupying the battle position, or while moving out of their fighting position to refuel.

(1) All levels must carefully plan and execute prestock operations. All leaders, down to vehicle commanders and squad leaders, must know the exact locations of prestock sites. During reconnaissance or rehearsals, they verify these locations. The platoon takes steps to ensure the survivability of the prestocked supplies. These measures include selecting covered and concealed positions and digging in the prestock positions. The

platoon leader must have a removal and destruction plan to prevent the enemy from capturing pre-positioned supplies.

(2) During offensive operations, the platoon can pre-position supplies on trucks or BFVs well forward on the battlefield. This works well if the platoon expects to use a large volume of fire, with corresponding ammunition requirements, during a fast-moving operation.

9-4. COMBAT LOAD AND BASIC LOAD

The platoon's combat load varies by mission and includes the supplies physically carried into the fight. The company commander directs some minimum requirements for the combat load. The unit SOP or the platoon leader specifies most items. The basic load includes supplies kept by the platoon for use in combat. The quantity of most basic load supply items depends on how many days in combat the platoon might have to sustain itself without resupply. For Class V ammunition, the higher commander or SOP specifies the platoon's basic load.

9-5. MAINTENANCE

Proper maintenance is the key to keeping vehicles, equipment, and other materials in serviceable condition. It is a continuous process starting with preventive measures taken by each vehicle crew and continuing through repair and recovery efforts by higher-level maintenance personnel. Maintenance services include inspecting, testing, servicing, repairing, requisitioning, recovering, and evacuating vehicles and equipment.

9-6. EVACUATION PROCEDURES

When combat begins and casualties occur, the platoon must first provide care for its wounded in action (WIA) soldiers. This initial care is provided by self-aid or buddy-aid. Advanced first aid is provided by the combat lifesaver. BFV commanders and squad leaders arrange for evacuation of WIAs to the CCP. The company normally sets up the CCP in a covered and concealed location to the rear of the platoons. At the company CCP, the medic (trauma specialist) triages all casualties, provides emergency medical treatment, and coordinates for evacuation of patients requiring additional treatment to the battalion aid station.

NOTE: Before the platoon evacuates casualties to the CCP or beyond, leaders should remove from the casualties' persons all key operational items and equipment, including signal operating instructions (SOI), maps, position-locating devices, and laser pointers. Every unit should establish an SOP for handling the weapons and ammunition of its WIA.

9-7. KILLED IN ACTION

The platoon leader designates a location for the collection of personnel KIA. All personal effects remain with the body, but the vehicle commander removes and safeguards any equipment and issue items. He keeps these until he can turn the equipment and issue items over to the platoon sergeant. The platoon sergeant turns over the KIA to the first sergeant. As a rule, the platoon should not transport KIA remains on the same vehicle as wounded soldiers.

9-8. ENEMY PRISONERS OF WAR

Enemy prisoners of war (EPWs) and captured enemy equipment and materiel often provide excellent combat information and intelligence. This information is of tactical value only if the platoon processes and evacuates prisoners and materials to the rear quickly.

a. In any tactical situation, the platoon will have specific procedures and guidelines for handling prisoners and captured material.

(1) The EPW handling procedure—search, segregate, silence, speed, safeguard—includes tagging prisoners using DD Form 2745, (Enemy Prisoner of War Capture Tag) and all captured equipment and materiel using equipment/document capture tags (Figure 9-3).

	TYPE DOCUMENT/EQUIPMENT	<u>MAP WITH GRAPHICS</u>
	DATE/TIME CAPTURED	<u>2017307 OCT 89</u>
	PLACE OF CAPTURE	<u>BAMBERG, FRG</u>
	(grid coordinates)	<u>PA 402306</u>
	CAPTURING UNIT	<u>RECON DLT, 7-6 IN</u>
	CIRCUMSTANCES OF CAPTURE (how it happened)	<u>FOUND IN HIDDEN COMPARTMENT OF TRENCHCOAT</u>
	PW FROM WHOM TAKEN	<u>NICOLAI FEDEROVICH</u>

Figure 9-3. Example equipment/document capture tag.

(2) In addition to initial processing, the capturing element provides guards and transportation to move prisoners to the designated EPW collection points. The capturing element normally carries prisoners on vehicles already heading toward the rear, such as tactical vehicles returning from LOGPAC operations. The capturing element must also feed, provide medical treatment for, and safeguard EPWs until they reach the collection point.

(3) Once the EPWs arrive at the collection point, the platoon sergeant assumes responsibility for them. He provides security for and transports them to the company team EPW collection point. He uses available personnel as guards to include the walking wounded or soldiers moving to the rear for reassignment.

9-9. AERIAL SUSTAINMENT

Aerial sustainment is an aviation mission that consists of moving personnel, equipment, material, and supplies by utility, cargo, and fixed-wing assets for use in operations other than air assault or combat support. Overland resupply might not work, due to terrain or the existing enemy threat. The platoon must initiate a request for resupply and must push it through company to battalion. The platoon must prepare to receive the supplies at the specified time and location.

9-10. CASUALTY EVACUATION

Casualty evacuation (CASEVAC) refers to the transport of casualties aboard nonstandard medical evacuation platforms, which include both ground vehicles and or aircraft. CASEVAC normally involves the process of getting casualties to the company CCP and

is overseen by the platoon sergeant and the first sergeant. Under mass casualty situations, the use of nonstandard medical evacuation platforms from supporting CS and CSS units may be necessary to provide CASEVAC.

APPENDIX A
PLATOON ORGANIZATION, SEATING,
AND VEHICLE DISMOUNTING DRILLS

This appendix outlines the organization and drills necessary for seating three squads of infantry in a BFV platoon. The platoon can fight mounted or dismounted, or as part of a task-organized company team of mechanized infantry and tank platoons. The M2A3-equipped platoon is similarly to a conventional Bradley platoon, but digital command and control enhancements provide additional options for the platoon leader.

A-1. MOUNTED ELEMENT

The decision to fight mounted or dismounted is made by the platoon leader based on the factors of METT-TC. Once the rifle squads have dismounted, the vehicles serve as a base-of-fire as the squads close with and destroy the enemy.

a. The mounted element (Figure A-1) is equipped with four BFVs organized as two, two-vehicle sections. When the squads and the platoon leader dismount, the platoon sergeant controls the two mounted sections. The “A” section leader is the platoon leader’s wingman and platoon master gunner. The “B” section leader is the platoon sergeant’s wingman. When the platoon leader dismounts, the platoon leader’s gunner becomes the BC, and an alternate gunner assumes the duties of gunner.

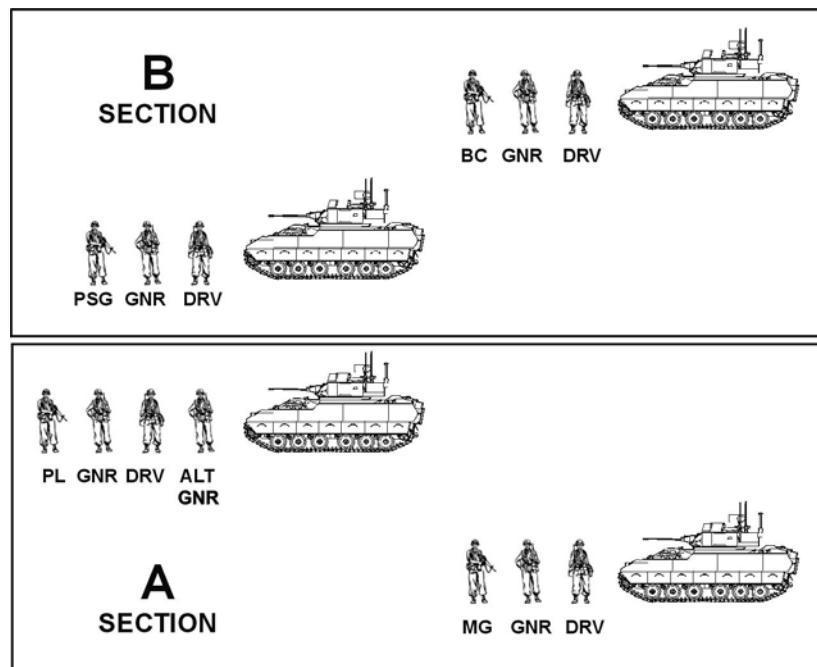

Figure A-1. Mounted element.

b. The BFV platoon has three rifle squads. Each rifle squad consists of two four-man fire teams and a squad leader (Figure A-2, page A-2) and has a command launch unit for the Javelin and an M240B machine gun. Two riflemen in the squad are trained and

qualified on the M240B—one as the gunner and the other as assistant gunner. Three nine-man squads make up the platoon’s dismounted element.

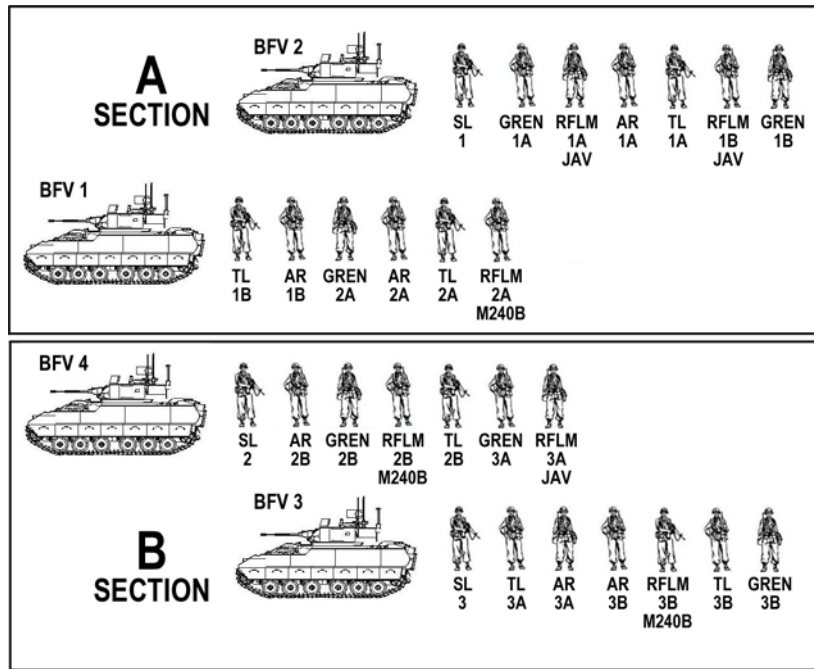

Figure A-2. Rifle squad vehicle assignment.

A-2. VEHICLE SEATING PLAN

Each vehicle provides seating for ten personnel—three vehicle crewmembers (BC, gunner, and driver) and seven soldier in the troop compartment (Figure A-3). This places a fire team (+) on each vehicle.

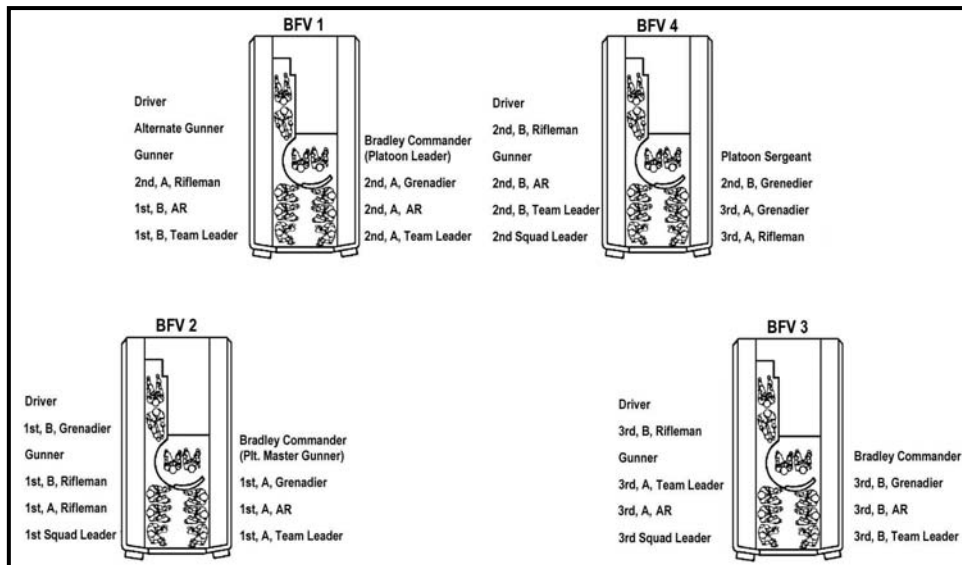

Figure A-3. BFV personnel seating.

A-3. VEHICLE DISMOUNTING DRILL

The BFV sections are the base elements for dismounting drills. The fact that a single vehicle cannot deliver a rifle squad intact warrants the need for section drills.

a. When the rifle squads prepare to exit, the BC coordinates with the senior infantry squad or team leader onboard. This coordination consists of orienting the squad or team leader with the terrain, enemy situation, and friendly situation through the intercom or with a map.

NOTE: Units equipped with the M2A3 use the view from the commander’s independent viewer (CIV) displayed on the squad leader’s CTD. The squad leader or senior fire team leader should sit on the right side forward seat. The BC should provide a view of the threat, the area of operations, other platoon vehicles, and covered and concealed positions close to the vehicle. While viewing the CIV and CTD screens and conducting voice coordination with the BC, the infantry squad or team leader provides specific instructions to the infantrymen.

b. Once he has finished coordinating, the leader can give a dismount order to the infantrymen onboard. Giving the order to dismount “LEFT” or “RIGHT” indicates which side of the vehicle the leader thinks provides the best terrain for an initial position. When the leader gives the dismount order, the driver immediately lowers the ramp. The squad or team leader positions himself at the rear of the vehicle and ensures the element is occupying the positions briefed in the vehicle. He must also visually locate the other vehicles, infantry squads, and the platoon.

c. First and third squad fire teams should locate close enough together to provide supporting fire for each other and to link up quickly. If terrain separates the two platoon sections, the second squad’s fire teams may not be able to link up quickly. In this event, the fire team would provide M240B supporting fires for the maneuvering squad. Figures A-4 through A-9 (pages A-3 through A-5) illustrate examples of platoon dismount drills.

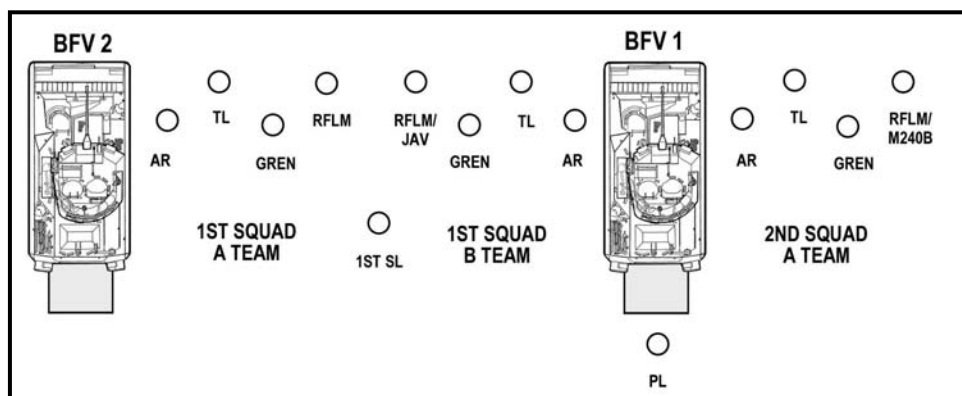

Figure A-4. Example dismount drill, A section, center.

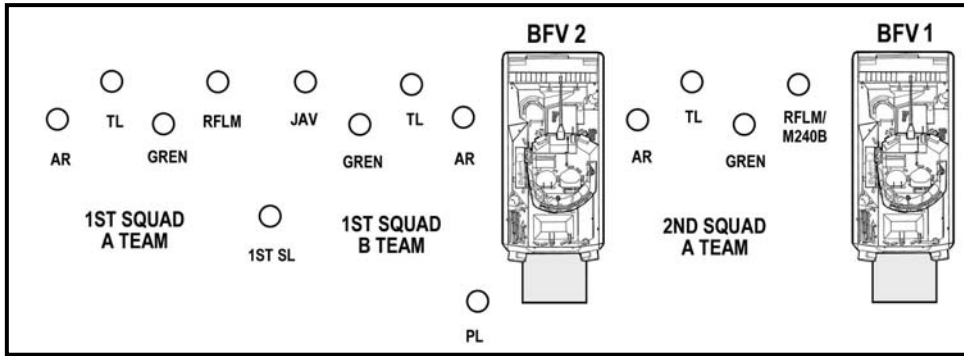

Figure A-5. Example dismount drill, A section, left.

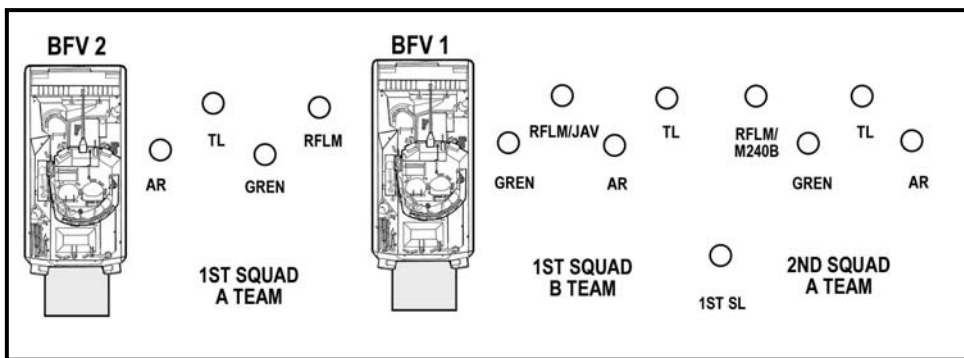

Figure A-6. Example dismount drill, A section, right.

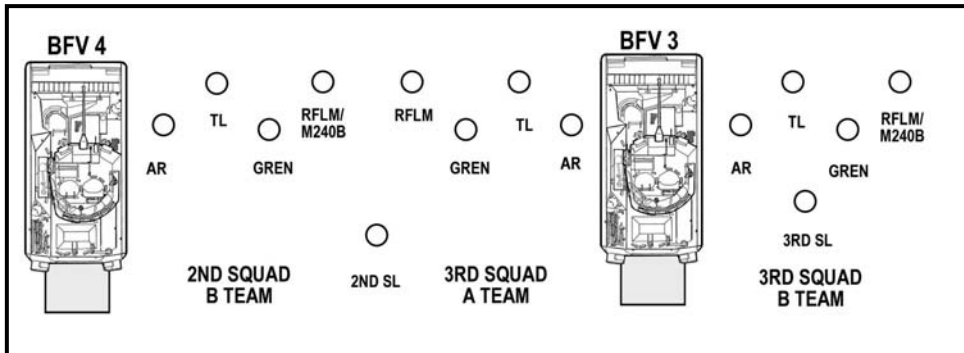

Figure A-7. Example dismount drill, B section, center.

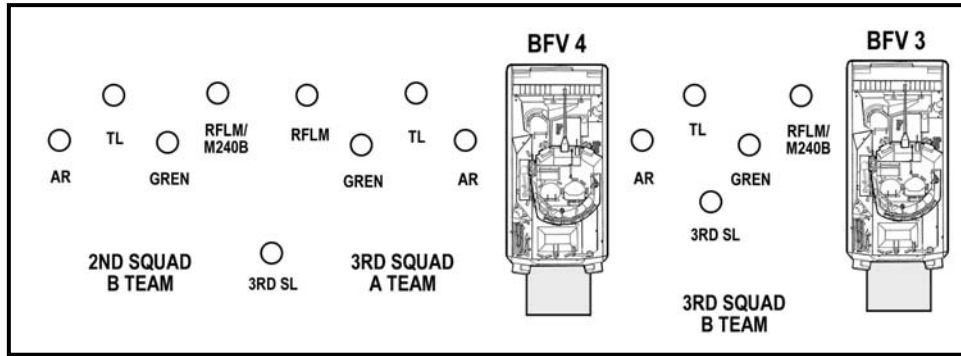

Figure A-8. Example dismount drill, B section, left.

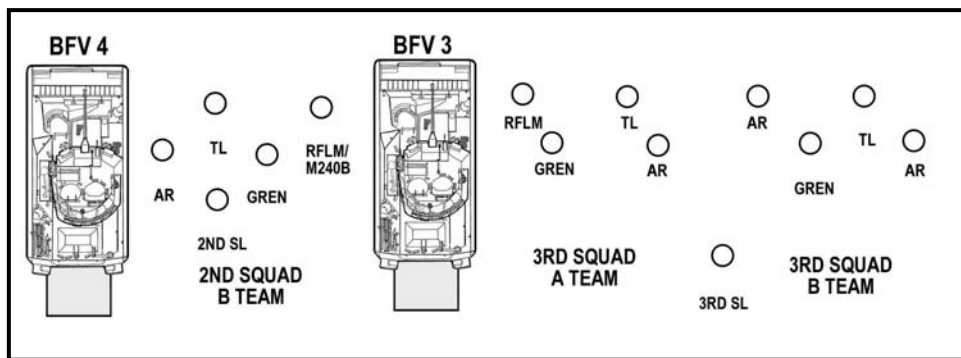

Figure A-9. Example dismount drill, B section, right.

APPENDIX B
**M240B MACHINE GUN AND
M249 SQUAD AUTOMATIC WEAPON EMPLOYMENT**

The M240B machinegun and the M249 squad automatic weapon provide the heavy volume of close and continuous fire needed to accomplish the mission, and they can engage targets beyond the capability of individual weapons with controlled and accurate fire. The long-range, close defensive, and final protective fires delivered by the M240B machine gun form an integral part of a unit's direct fire plan. This appendix addresses the fundamental techniques of fire common to both the machine gun and the M249.

B-1. M240B MACHINE GUN

The M242 (25-mm cannon) and the M240C (coaxial machine gun) provide high-volume, accurate firepower from a stable and mobile platform. Rifle squads are generally focused on a dismounted enemy. While the BFVs are intended to provide the necessary direct fire support to the rifle squads, some situation may orient them in a different direction. The mounted element may not in the best position to provide this type of direct fire support to the dismounted element. When positioned to engage armored or mounted formations, their focus and primary targets often are different from that of the rifle squads. METT-TC will dictate separating the mounted section from the rifle squads making supporting direct fires difficult, if not almost impossible. It is under these circumstances that the platoon leader employs his M240B machine guns with the dismounted element, or with a rifle squad to provide long range, accurate, sustained fires under all visibility conditions against dismounted infantry, apertures in fortifications, buildings, and lightly armored vehicles and trucks. They also provide a high volume of short-range fire in self-defense against enemy aircraft. Machine gunners use point, traversing, searching, or searching and traversing fire to kill or suppress targets. The machine gun is the infantry platoon's primary weapon against a dismounted enemy (Table B-1, page B-2 provides specifications for the M240B). It provides a high volume of lethal, accurate fire to break up an enemy assault; it has limited effects against lightly armored vehicles; and it causes vehicle crews to button-up and operate with reduced effectiveness. Leaders position machine guns to—

- Concentrate fires where they want to kill the enemy.
- Fire across the platoon front.
- Cover obstacles by direct fire.
- Tie-in with adjacent units.

a. In the offense the platoon leader has the option, based on his analysis of the factors of METT-TC, to establish his base of fire element with one or two machine guns, the M249, or a combination of the two weapons. The platoon sergeant may position this element and control its fires when the platoon scheme of maneuver is to conduct the assault with the three dismounted squads. The machine gun, when placed on tripods, provides stability and accuracy at greater ranges than the bipod. The machine gunners target key enemy weapons until the assault element masks their fires. They can also suppress the enemy's ability to return accurate fire or to hamper the maneuver of the

assault element. They fix the enemy in position and isolate him by cutting off his avenues of reinforcement. They then shift their fires to the flank opposite the one being assaulted and continue to target any enemy automatic weapons that provide mutual support to his position, or engage any enemy counterattack. Their fires can also be used to cover the gap created between the forward element of the assaulting force and terrain covered by indirect fires when the indirect fires are lifted and shifted. On signal, the machine gunners and the base of fire element displace to join the assault element on the objective.

b. In the defense the machine gun provides sustained direct fires that cover the most likely or most dangerous dismounted avenues of approach and protect the unit against the enemy’s dismounted close assault. The platoon leader positions his machine guns to concentrate fires in locations where he wants to do the most damage to the dismounted enemy and where they can take advantage of grazing enfilade fires, stand-off or maximum engagement range, and best observation of the target area. They provide overlapping and interlocking fires with adjacent units and cover tactical and protective obstacles with traversing or searching fires. When final protective fires are called for, machine guns (aided by M249 fires) place an effective barrier of fixed, direct fire across the platoon front.

B-2. M249 SQUAD AUTOMATIC WEAPON EMPLOYMENT

The M249 is primarily a squad leader’s weapon to use in the close fight as a light automatic weapon. (Table B-1 provides specifications for the M249.) The M249 provides the rifle squads with a light automatic weapon to take with them into the assault. These weapons fire from the bipod, from the hip, or from the underarm position. They target any enemy supporting weapons being fired from fixed positions anywhere on the squad’s objective. When the enemy’s supporting weapons have been destroyed, or if there are none, the M249 gunners distribute their fire over that portion of the objective that corresponds to their team’s position. The M249 in the hands of a rifleman can provide mobility and a high volume of fire up front in the assault, or across the squad’s position in the defense. In the defense, they add the firepower of 10 or 20 riflemen without the addition of manpower. Characteristically, M249s are light, they fire rapidly, and have more ammunition than the rifles in the squad they support. Under certain circumstances the platoon leader may designate it as a machine gun and, with some adjustments, use it as a platoon weapon.

SPECIFICATIONS	M240B	M249
Size	7.62-mm gas operated machine gun	5.56-mm gas operated automatic
Weight	25.63 lb (11.1 kg)	15.07 lb (6.85 kg)
Length	1105 mm	1040 mm standard
Muzzle Velocity	853 m/s	965 m/s
Rate of Fire	Cyclic 650-850 rds/min	Cyclic 650-850 rds/min
Effective Ranges: Point	800 m	600 m
Area	1100 m (Tripod)	800 m

Table B-1. Specifications for M240B and M249.

B-3. FUNDAMENTAL TECHNIQUES OF AUTOMATIC FIRE

The fundamental techniques of automatic fire are common to machine guns and squad automatic weapons. (For more detailed information refer to FMs 23-67 and 23-14.)

a. **Techniques of Fire.** Techniques of fire include direct lay, assault fire, overhead fire, and fire from a defilade position. Only automatic rifles use assault fire. Only machine guns can employ overhead fire.

(1) **Direct Lay.** Gunners and automatic riflemen use the direct-lay technique by aligning the sights of the weapon on the target. This is the easiest and quickest means of delivering fire.

(2) **Assault Fire.** Automatic riflemen use assault fire when in close combat. Assault fire involves firing without the aid of sights, using the hip, shoulder, and underarm positions. The underarm position is best when rapid movement is required. In all three positions, automatic riflemen adjust their fire by observing the tracer and the impact of the bullets in the target area. Additional considerations for automatic riflemen using assault fire include—

- Maintaining alignment with the rest of the assault element.
- Reloading rapidly.
- Aiming low and adjusting the aim upward toward the target.
- Distributing fires across the objective when not engaging enemy automatic weapons.

(3) **Overhead Fire.** Gunners can use overhead fire when there is sufficient low ground between the machine gun and the target area for the maneuver of friendly forces. Normally, overhead fires are conducted with the machine guns on tripods, because they provide greater stability and accuracy, and the vertical mil angles can be measured by using the elevating mechanism. Gunners must accurately estimate range to the target and establish a safety limit that is an imaginary line, parallel to the target, where fire would cause casualties to friendly soldier. Gun crews and leaders must be aware of this safety limit. Leaders must designate signals for lifting or shifting fires. Gunners should not attempt overhead fires if the terrain is level or slopes uniformly, if the barrel is badly worn, or if visibility is poor.

(4) **Fire from a Defilade Position.** Defilade positions protect gunners from frontal or enfilading fires. Cover and concealment may not provide the gunner a view of some or all of the target area. In this instance, some other member of the platoon must observe the impact of the rounds and communicate adjustments to the gunner. Gunners and leaders must consider the complexity of laying on the target, the gunner's inability to make rapid adjustments to engage moving targets, the ease with which targets are masked, and the difficulty in achieving grazing fires for a final protective line.

b. **Characteristics of Fire.** To help the gunner understand the characteristics of fire for their weapons, the following definitions are helpful:

(1) **Trajectory.** Trajectory is the path of the bullet in flight. For the M249, the path of the bullet is almost flat at ranges of 300 meters or less. At ranges beyond 300 meters, the trajectory curves as the range increases.

(2) **Maximum Ordinate.** This is the highest point the trajectory reaches between the muzzle of the weapon and the base of the target. It always occurs at a point about two-thirds of the distance from weapon to target and increases with range.

(3) **Cone of Fire.** This is the pattern formed by the different trajectories in each burst as they travel downrange. Vibration of the weapon, variations in ammunition, and atmospheric conditions all contribute to the trajectories that make up the cone of fire.

(4) **Beaten Zone.** This is the pattern formed by the rounds within the cone of fire striking the ground or the target. The size and shape of the beaten zone changes as a function of the range to and slope of the target. Gunners and automatic riflemen should engage targets to take maximum effect of the beaten zone. The simplest way to do this is to aim at the center base of the target. Most rounds will not fall over the target, and any that fall short will create ricochets into the target.

(5) **Danger Space.** This is the space between the weapon and the target where the trajectory does not rise above 1.8 meters (the average height of a standing soldier) and includes the beaten zone. Gunners should consider the danger space of their weapons when planning overhead fires.

c. **Classifications of Automatic Weapons Fire.** The US Army classifies automatic weapon fires with respect to the ground, the target, and the weapon.

(1) Fire with respect to the ground includes—

- *Grazing Fire.* Automatic weapons achieve grazing fire when the center of the cone of fire does not rise more than 1 meter above the ground. When firing over level or uniformly sloping terrain, the M249 can attain a maximum of 600 meters of grazing fire.
- *Plunging Fire.* Plunging fire occurs when weapons fire at long range, when firing from high ground to low ground, when firing into abruptly rising ground, or when firing across uneven terrain, resulting in a loss of grazing fire at any point along the trajectory.

(2) Fire with respect to the target includes—

- *Enfilade Fire.* Enfilade fire occurs when the long axis of the beaten zone coincides or nearly coincides with the long axis of the target. It can be frontal or flanking. It is the most desirable class of fire with respect to the target because it makes maximum use of the beaten zone.
- *Frontal Fire.* Frontal fire occurs when the long axis of the beaten zone is at a right angle to the front of the target.
- *Flanking Fire.* Flanking fire is delivered directly against the flank of a target.
- *Oblique Fire.* Gunners and automatic riflemen achieve oblique fire when the long axis of the beaten zone is at an angle other than a right angle to the front of the target.

(3) Fire with respect to the weapon includes—

- *Fixed Fire.* Fixed fire is delivered against a stationary point target when the depth and width of the beaten zone will cover the target.
- *Traversing Fire.* Traversing distributes fires in width by successive changes in direction.
- *Searching Fire.* Searching distributes fires in depth by successive changes in elevation.
- *Traversing and Searching Fire.* This class of fire is a combination in which successive changes in direction and elevation result in the distribution of fires both in width and depth.

d. **Types of Targets.** Targets have both width and depth. The size of the target, stated in terms of the number of aiming points required to engage it completely, determines its type.

(1) **Point Target.** Point targets require a single aiming point. Examples of this include bunkers, weapons emplacements, vehicles, and troops.

(2) **Area Targets.** Area targets require more than one aiming point. Machine gunners and automatic riflemen use traversing and searching (or a combination) to engage the target. Area targets are distinguished as linear, deep, and linear with depth. Gunners and automatic riflemen engage deep targets using searching fire. They engage linear targets using traversing fire. Finally, they engage linear with depth targets using traversing and searching fire.

e. **Rates of Fires** Automatic weapons fire in one of three rates: rapid, sustained, or cyclic. Normally machine gunners engage targets at the rapid rate to suppress the enemy quickly. Thereafter, they fire at a sustained rate to conserve ammunition. Automatic riflemen use the three-round burst, resighting their weapons as quickly as possible. In engaging aerial targets, machine gunners and automatic riflemen use the cyclic rate.

(1) **Rapid Fire.** Rapid fire is 200 rounds per minute in bursts of six to nine rounds at four- to five-second intervals.

(2) **Sustained Rate.** Sustained fire is 100 rounds per minute in bursts of six to nine rounds at four- to five-second intervals.

(3) **Cyclic Rate.** The normal cyclic rate of fire is 650 to 850 rounds per minute. To fire the cyclic rate, the gunner holds the trigger to the rear while the assistant gunner feeds ammunition into the weapon.

f. **Techniques for Automatic Weapons in the Defense.** Machine gunners and automatic riflemen use a number of techniques to ensure effective fires in defensive operations. Some techniques tie the characteristics of the weapons to the nature of the terrain. Others ensure distribution of fires across the squad or platoon front. Still others facilitate the concentration of fires against likely enemy avenues of approach or in engagement areas bounded by tactical obstacles. Finally, others aid in maintaining accurate fires during limited visibility. (For a detailed discussion refer to Appendix G.)

g. **Field-Expedient Methods.** The two most common field-expedient methods for laying the machine gun in the bipod mode on predetermined targets are the notched-stake or tree-crotch and the horizontal log or board technique.

(1) **Notched-Stake or Tree-Crotch Technique.** This technique is effective for all conditions of visibility. It involves sighting the weapon on each target and marking the position and elevation of the stock with a notched-stake or tree-crotch. The automatic rifleman then scoops out a shallow groove to provide for the movement of the bipod legs and to keep the front end of the weapon aligned.

(2) **Horizontal Log or Board Technique.** Automatic riflemen use this technique to mark sector limits and engage linear targets. It is best suited for flat, level terrain and involves placing a log or board horizontally so the weapon slides along it easily. The board may then be notched along its length to lay the weapon on a specific target reference point. It may also have limiting stakes placed to define the left and right limits of the weapon.

h. **Fire Control.** Leaders control the engagements of their automatic weapons through the use of control measures, coordinating instructions, and fire commands. (For a detailed discussion of direct fire control refer to Appendix G.)

(1) In the offense, coordinating instructions to machine gunners include instructions to initiate fires, a description of how the platoon leader sees the sequence of automatic weapon engagements and the location of other friendly soldiers in the area.

(2) In the defense, the leader describes the presence and subsequent action of friendly soldiers to the front of the platoon position (scouts, passing units), the initiation and sequence of weapon engagements, priority targets, and the planned or probable shifting of forces to displace or counterattack.

(3) The signal to initiate fires or FPLs or any occasions not covered by planning can be handled through fire commands. Fire commands must be clear and concise. Machine gunners and automatic riflemen repeat all fire commands. Fire commands contain the following elements:

- *Alert.* The leader must specify WHO is to engage.
- *Direction.* The leader must clearly indicate the general direction of the target. He may do so orally (giving a general orientation or designation of a reference point) by pointing, or by directing fires with tracer rounds from his own weapon. If he uses tracers, this becomes the last part of the command, and he directs, "Watch my tracer."
- *Description.* While visually following the target, the leader briefly describes the target, generally by the type of object: troops, vehicles, aircraft.
- *Range.* Leaders provide an estimate of the range to the target. Gunners and automatic riflemen use this estimate to set their rear sights, and to know how far to look to identify the target.
- *Method of Fire.* This element includes two parts: the manipulation (class of fire with respect to the weapon--fixed, traversing, searching, or traversing and searching) and the rate of fire. When the leader omits the rate of fire, the gunner assumes a rapid rate.
- *Command to Open Fire.* Timing the initiation of fires is important to gain surprise. Leaders may preface the command to commence firing with "At my command" or "At my signal." Gunners and automatic riflemen respond with "Ready" when they have identified the target and are ready to engage. Leaders then give the specified command or signal.

(4) Leaders adjust fires (direction, elevation, and rate), identify new targets, order cease-fires, or terminate the alert with subsequent fire commands.

(5) Squads and platoons establish SOPs governing the activities and automatic initiation, control, and cessation of fire for their automatic riflemen and gunners. These SOP items can include standard targets and how often to check with leaders once they have engaged the enemy.

i. **Dead Space Considerations.** Dead space defines an area where the waist of a soldier falls below a gunner's or automatic rifleman's point of aim. The most accurate method for determining dead space is to have one soldier walk the line of sight of the weapon (FPL or PDF) and make a pace count of those areas where he encounters dead space. Dead space can also be determined by observing the flight of tracer ammunition from a position behind and to the flank of the weapon.

APPENDIX C

RISK MANAGEMENT

Risk is the chance of injury or death for individuals and damage to or loss of vehicles and equipment. Risk, or the potential for risk, is always present in every combat and training situation the platoon faces. Risk management must take place at all levels of the chain of command during each phase of every operation; it is an integral part of all tactical planning. The platoon leader, his NCOs, and all other platoon soldiers must know how to use risk management, coupled with fratricide reduction measures, to ensure that the mission is executed in the safest possible environment within mission constraints.

The primary objective of risk management is to help units protect their combat power through accident prevention, enabling them to win the battle quickly and decisively with minimal losses. This appendix outlines the process leaders use to identify hazards and implement a plan to address each identified hazard. It also includes a detailed discussion of the responsibilities of the platoon's leaders and individual soldiers in implementing a sound risk management program. For additional information on risk management, refer to FM 100-14.

Section I. RISK MANAGEMENT PROCEDURES

This section outlines the five steps of risk management. Leaders of the platoon must always remember that the effectiveness of the process depends on situational awareness. They should never approach risk management with “one size fits all” solutions to the hazards the platoon will face. Rather, in performing the steps, they must keep in mind the essential tactical and operational factors that make each situation unique.

C-1. STEP 1, IDENTIFY HAZARDS

A hazard is a source of danger. It is any existing or potential condition that could entail injury, illness, or death of personnel; damage to or loss of equipment and property; or some other sort of mission degradation. Tactical and training operations pose many types of hazards. The platoon leader must identify the hazards associated with all aspects and phases of the platoon's mission, paying particular attention to the factors of METT-TC. Risk management must never be an afterthought; leaders must begin the process during their troop-leading procedures and continue it throughout the operation. Table C-1, page C-2, lists possible sources of battlefield hazards that the platoon might face during a typical tactical operation. The list is organized according to the factors of METT-TC.

<p>MISSION</p> <ul style="list-style-type: none"> • Duration of the operation. • Complexity/clarity of the plan. (Is the plan well-developed and easily understood?) • Proximity and number of maneuvering units.
<p>ENEMY</p> <ul style="list-style-type: none"> • Knowledge of the enemy situation. • Enemy capabilities. • Availability of time and resources to conduct reconnaissance.
<p>TERRAIN AND WEATHER</p> <ul style="list-style-type: none"> • Visibility conditions, including light, dust, fog, and smoke. • Precipitation and its effect on mobility. • Extreme heat or cold. • Additional natural hazards (broken ground, steep inclines, water obstacles).
<p>TROOPS</p> <ul style="list-style-type: none"> • Equipment status. • Experience the units conducting the operation have working together. • Danger areas associated with the platoon’s weapon systems. • Soldier/leader proficiency. • Soldier/leader rest situation. • Degree of acclimatization to environment. • Impact of new leaders or crewmembers. • Friendly unit situation. • NATO or multinational military actions combined with U.S. forces.
<p>TIME AVAILABLE</p> <ul style="list-style-type: none"> • Time available for troop-leading procedures and rehearsals by subordinates. • Time available for PCCs/PCIs.
<p>CIVILIAN CONSIDERATIONS</p> <ul style="list-style-type: none"> • Applicable ROE or ROI. • Potential stability and support operations involving contact with civilians (such as NEOs, refugee or disaster assistance, or counterterrorism). • Potential for media contact and inquiries. • Interaction with host nation or other participating nation support.

Table C-1. Examples of potential hazards.

C-2. STEP 2, ASSESS HAZARDS TO DETERMINE RISKS

Hazard assessment is the process of determining the direct impact of each hazard on an operation (in the form of hazardous incidents). Use the following steps.

- a. Determine hazards that can be eliminated or avoided.
- b. Assess each hazard that cannot be eliminated or avoided to determine the probability that the hazard can occur.
- c. Assess the severity of hazards that cannot be eliminated or avoided. Severity, defined as the result or outcome of a hazardous incident, is expressed by the degree of injury or illness (including death), loss of or damage to equipment or property, environmental damage, or other mission-impairing factors (such as unfavorable publicity or loss of combat power).

d. Taking into account both the probability and severity of a hazard, determine the associated risk level (extremely high, high, moderate, and low). Table C-2 summarizes the four risk levels.

e. Based on the factors of hazard assessment (probability, severity, and risk level, as well as the operational factors unique to the situation), complete the risk management worksheet. (Refer to FM 100-14 for an example of a completed risk management worksheet.)

RISK LEVEL	MISSION EFFECTS
Extremely High (E)	Mission failure if hazardous incidents occur in execution.
High (H)	Significantly degraded mission capabilities in terms of required mission standards. Not accomplishing all parts of the mission or not completing the mission to standard (if hazards occur during mission).
Moderate (M)	Expected degraded mission capabilities in terms of required mission standards. Reduced mission capability (if hazards occur during the mission).
Low (L)	Expected losses have little or no impact on mission success.

Table C-2. Risk levels and impact on mission execution.

C-3. STEP 3, DEVELOP CONTROLS AND MAKE RISK DECISIONS

This step is accomplished in two substeps: develop controls and make risk decisions. These substeps are accomplished during the “make a tentative plan” step of the troop-leading procedures.

a. **Developing Controls.** After assessing each hazard, develop one or more controls that will either eliminate the hazard or reduce the risk (probability, severity, or both) of potential hazardous incidents. When developing controls, consider the reason for the hazard, not just the hazard by itself.

b. **Making Risk Decisions.** A key element in the process of making a risk decision is determining whether accepting the risk is justified or, conversely, is unnecessary. The decision-maker (the platoon leader, if applicable) must compare and balance the risk against mission expectations. He alone decides if the controls are sufficient and acceptable, and whether to accept the resulting residual risk. If he determines the risk is unnecessary, he directs the development of additional controls or alternative controls; as another option, he can modify, change, or reject the selected COA for the operation.

C-4. STEP 4, IMPLEMENT CONTROLS

Controls are the procedures and considerations the unit uses to eliminate hazards or reduce their risk. Implementing controls is the most important part of the risk management process; this is the chain of command’s contribution to the safety of the unit. Implementing controls includes coordination and communication with appropriate superior, adjacent, and subordinate units and with individuals executing the mission. The platoon leader must ensure that specific controls are integrated into OPLANs, OPORDs,

SOPs, and rehearsals. The critical check for this step is to ensure that controls are converted into clear, simple execution orders understood by all levels. If the leaders have conducted a thoughtful risk assessment, the controls will be easy to implement, enforce, and follow. Examples of risk management controls include the following:

- Thoroughly brief all aspects of the mission, including related hazards and controls.
- Conduct thorough PCCs and PCIs.
- Allow adequate time for rehearsals at all levels.
- Drink plenty of water, eat well, and get as much sleep as possible (at least 4 hours in any 24-hour period).
- Use buddy teams.
- Enforce speed limits, use of seat belts, and driver safety.
- Establish recognizable visual signals and markers to distinguish maneuvering units.
- Enforce the use of ground guides in assembly areas and on dangerous terrain.
- Establish marked and protected sleeping areas in assembly areas.
- Limit single-vehicle movement.
- Establish SOPs for the integration of new personnel.

C-5. STEP 5, SUPERVISE AND EVALUATE

During mission execution, leaders must ensure that risk management controls are properly understood and executed. Leaders must continuously evaluate the unit's effectiveness in managing risks to gain insight into areas that need improvement.

a. **Supervision.** Leadership and unit discipline are the keys to ensuring that effective risk management controls are implemented.

(1) All leaders are responsible for supervising mission rehearsals and execution to ensure standards and controls are enforced. In particular, NCOs must enforce established safety policies as well as controls developed for a specific operation or task. Techniques include spot checks, inspections, SITREPs, confirmation briefs, buddy checks, and close supervision.

(2) During mission execution, leaders must continuously monitor risk management controls, both to determine whether they are effective and to modify them as necessary. Leaders must also anticipate, identify, and assess new hazards. They ensure that imminent danger issues are addressed on the spot and that ongoing planning and execution reflect changes in hazard conditions.

b. **Evaluation.** Whenever possible, the risk management process should also include an after-action review (AAR) to assess unit performance in identifying risks and preventing hazardous situations. During an AAR, leaders should assess if the implemented controls were effective. Following the AAR, leaders should incorporate lessons learned from the process into unit SOPs and plans for future missions.

Section II. IMPLEMENTATION RESPONSIBILITIES

Leaders and individuals at all levels are responsible and accountable for managing risk. They must ensure that hazards and associated risks are identified and controlled during planning, preparation, and execution of operations. The platoon leader and his senior

NCOs must look at both tactical risks and accident risks. The same risk management process is used to manage both types. The platoon leader alone determines how and where he is willing to take tactical risks. The platoon leader manages accident risks with the assistance of his platoon sergeant, NCOs, and individual soldiers.

C-6. BREAKDOWN OF THE RISK MANAGEMENT PROCESS

Despite the need to advise higher headquarters of a risk taken or about to be assumed, the risk management process may break down. Such a failure can be the result of several factors; most often, it can be attributed to the following:

- The risk denial syndrome in which leaders do not want to know about the risk.
- A soldier who believes that the risk decision is part of his job and does not want to bother his platoon leader or section leader.
- Outright failure to recognize a hazard or the level of risk involved.
- Overconfidence on the part of an individual or the unit in being able to avoid or recover from a hazardous incident.
- Subordinates who do not fully understand the higher commander's guidance regarding risk decisions.

C-7. RISK MANAGEMENT COMMAND CLIMATE

The platoon leader gives the platoon direction, sets priorities, and establishes the command climate (values, attitudes, and beliefs). Successful preservation of combat power requires him to embed risk management into individual behavior. To fulfill this commitment, the platoon leader must exercise creative leadership, innovative planning, and careful management. Most importantly, he must demonstrate support for the risk management process.

a. The platoon leader and others in the platoon chain of command can establish a command climate favorable to risk management integration by taking the following actions:

- Demonstrate consistent and sustained risk management behavior through leadership by example and emphasis on active participation throughout the risk management process.
- Provide adequate resources for risk management. Every leader is responsible for obtaining the assets necessary to mitigate risk and for providing them to subordinate leaders.
- Understand your own and your soldiers' limitations, as well as your unit's capabilities.
- Allow subordinates to make mistakes and learn from them.
- Prevent a "zero defects" mindset from creeping into the platoon's culture.
- Demonstrate full confidence in subordinates' mastery of their trade and their ability to execute a chosen COA.
- Keep subordinates informed.
- Listen to subordinates.

b. For the platoon leader, his subordinate leaders, and individual soldiers, responsibilities in managing risk include the following:

- Make informed risk decisions. Establish and then clearly communicate risk decision criteria and guidance.

- Establish clear, feasible risk management policies and goals.
- Train the risk management process. Ensure that subordinates understand the who, what, when, where, and why of managing risk and how these factors apply to their situation and assigned responsibilities.
- Accurately evaluate the platoon's effectiveness, as well as subordinates' execution of risk controls during the mission.
- Inform higher headquarters when risk levels exceed established limits.

APPENDIX D

FRATRICIDE AVOIDANCE

Fratricide is defined as the employment of friendly weapons that results in the unforeseen and unintentional death or injury of friendly personnel or damage to friendly equipment. Fratricide prevention is the platoon leader's responsibility. All leaders across all operating systems assist the platoon leader in accomplishing this mission. This appendix focuses on actions the platoon leader and his subordinate leaders can take with current resources to reduce the risk of fratricide.

In any tactical situation, it is critical that every platoon member know where he is and where other friendly elements are operating. With this knowledge, he must anticipate dangerous conditions and take steps either to avoid or to mitigate them. The platoon leader must always be vigilant of changes and developments in the situation that may place his sections and teams in danger. He must also ensure that all squad and team positions are constantly reported to higher headquarters so that all other friendly elements are aware of where they are and what they are doing. When the platoon leader perceives a potential fratricide situation, he must personally use the higher net to coordinate directly with the friendly element involved.

D-1. EFFECTS

Fratricide results in unacceptable losses and increases the risk of mission failure; it almost always affects the unit's ability to survive and function. Units experiencing fratricide suffer these consequences:

- Loss of confidence in the unit's leadership.
- Increasing self-doubt among leaders.
- Hesitancy in the employment of supporting combat systems.
- Over-supervision of units.
- Hesitancy in the conduct of night operations.
- Loss of aggressiveness in maneuver.
- Loss of initiative.
- Disrupted operations.
- General degradation of unit cohesiveness, morale, and combat power.

D-2. CAUSES

The following paragraphs discuss the primary causes of fratricide. Leaders must identify any of the factors that may affect their units and then strive to eliminate or correct them.

a. **Failures in the Direct Fire Control Plan.** These occur when units do not develop effective fire control plans, particularly in the offense. Units may fail to designate engagement areas or to adhere to the direct fire plan, or they may position their weapons incorrectly. Under such conditions, fire discipline often breaks down upon contact. An area of particular concern is the additional planning that must go into

operations requiring close coordination between mounted elements and dismounted teams.

b. **Land Navigation Failures.** Units often stray out of assigned sectors, report wrong locations, and become disoriented. Much less frequently, they employ fire support weapons in the wrong location. In either type of situation, units that unexpectedly encounter another unit may fire their weapons at the friendly force.

c. **Failures in Combat Identification.** Vehicle commanders and machine gun crews cannot accurately identify the enemy near the maximum range of their systems. In limited visibility, friendly units within that range may mistake one another as the enemy.

d. **Inadequate Control Measures.** Units may fail to disseminate the minimum necessary maneuver control measures and direct fire control measures. They may also fail to tie control measures to recognizable terrain or events. As the battle develops, the plan cannot address branches and sequels as they occur. When this happens, synchronization fails.

e. **Failures in Reporting and Communications.** Units at all levels may fail to generate timely, accurate, and complete reports as locations and tactical situations change. This distorts the common operating picture at battalion and brigade level (available on FBCB2) and can lead to erroneous clearance of fires.

f. **Weapons Errors.** Lapses in individual discipline can result in fratricide. These incidents include charge errors, accidental discharges, mistakes with explosives and hand grenades, and use of incorrect gun data.

g. **Battlefield Hazards.** A variety of explosive devices and materiel may create danger on the battlefield—unexploded ordnance, booby traps, and unmarked or unrecorded minefields, including scatterable mines. Failure to mark, record, remove, or otherwise anticipate these threats leads to casualties.

h. **Reliance on Instruments.** A unit that relies too heavily on systems such as GPS devices or FBCB2 (M2A3-equipped units only) will find its capabilities severely degraded if these systems fail. The unit will be unable to maintain situational understanding because it will not have a common operational picture (COP). To prevent potential dangers when system failure occurs, the platoon leader must ensure that he and his platoon use a balance of technology with traditional basic soldier skills in observation, navigation, and other critical activities.

D-3. PREVENTION

The measures outlined in this paragraph provide the platoon with a guide to actions it can take to reduce or prevent fratricide risk. These guidelines are not intended to restrict initiative. Leaders must learn to apply them as appropriate based on the specific situation and the factors of METT-TC.

a. **Principles.** At the heart of fratricide reduction and prevention are five key principles:

(1) **Identify and Assess Potential Fratricide Risks During the Troop-Leading Procedures.** Incorporate risk reduction control measures in WARNOs, the OPORD, and applicable FRAGOs.

(2) **Maintain Situational Understanding.** Focus on areas such as current intelligence, unit locations and dispositions, obstacles, NBC contamination, SITREPs, and the factors

of METT-TC. An M2A3-equipped platoon gains an advantage in situational understanding with FBCB2 by automatically updating the COP.

(3) **Ensure Positive Target Identification.** Review vehicle and weapons identification cards. Become familiar with the characteristics of potential friendly and enemy vehicles, including their silhouettes and thermal signatures. This knowledge should include the conditions, including distance (range) and weather, under which positive identification of various vehicles and weapons is possible. Enforce the use of challenge and password, especially during dismounted operations.

(4) **Maintain Effective Fire Control.** Ensure fire commands are accurate, concise, and clearly stated. Make it mandatory for soldiers to ask for clarification of any portion of the fire command that they do not completely understand. Stress the importance of the chain of command in the fire control process, and ensure soldiers get in the habit of obtaining target confirmation and permission to fire from their leaders before engaging targets they assume are enemy elements. Know who will be in and around the area of operations.

(5) **Establish a Command Climate that Emphasizes Fratricide Prevention.** Enforce fratricide prevention measures, placing special emphasis on the use of doctrinally sound techniques and procedures. Ensure constant supervision in the execution of orders and in the performance of all tasks and missions to standard.

b. **Guidelines and Considerations.** Additional guidelines and considerations for fratricide reduction and prevention include the following.

(1) Recognize the signs of battlefield stress. Maintain unit cohesion by taking quick, effective action to alleviate stress.

(2) Conduct individual, leader, and collective (unit) training covering fratricide awareness, target identification and recognition, and fire discipline.

(3) Develop a simple, executable plan.

(4) Give complete and concise operation orders. Include all appropriate recognition signals in paragraph 5 of the OPORD.

(5) To simplify operation orders, use SOPs that are consistent with doctrine. Periodically review and update SOPs as needed.

(6) Strive to provide maximum planning time for leaders and subordinates.

(7) Use common language (vocabulary) and doctrinally correct standard terminology and control measures.

(8) Ensure thorough coordination is conducted at all levels.

(9) Plan for and establish effective communications.

(10) Plan for collocation of CPs whenever it is appropriate to the mission, such as during a passage of lines.

(11) Make sure ROE are clear.

(12) Conduct rehearsals whenever the situation allows adequate time to do so.

(13) Be in the right place at the right time. Use position location and navigation devices (GPS or POSNAV), know your location and the locations of adjacent units (left, right, leading, and follow-on), and synchronize tactical movement. If the platoon or any element becomes lost, its leader must know how to contact higher headquarters immediately for instructions and assistance.

(14) Establish, execute, and enforce strict sleep and rest plans.

APPENDIX E

BATTLE DRILLS AND CREW DRILLS

Mechanized infantry battle and crew drills describe how platoons and squads apply immediate action and fire and maneuver to commonly encountered situations and equipment malfunctions. They require leaders to make decisions rapidly and to issue brief oral orders quickly. A platoon's ability to accomplish its mission often depends on soldiers, leaders, and squads and sections executing key actions quickly. All soldiers and their leaders must know their immediate reaction to enemy contact and equipment malfunction as well as follow-up actions.

Drills are limited to situations requiring instantaneous response; therefore, soldiers must execute drills instinctively, which results from continual practice. Drills provide platoons with standard procedures essential for building strength and aggressiveness. They identify key actions that leaders and soldiers must perform quickly. They provide for a smooth transition from one activity to another; for example, from movement to offensive action to defensive action. They provide standardized actions that link soldier and collective tasks at platoon level and below. (Soldiers perform individual tasks to CTT standard.) Drills must be understood by each individual and leader, and continually practiced by the platoon.

The format for drills discussed in this chapter includes the title, the SITUATION that would cue the unit or the leader into initiating the drill, the REQUIRED ACTIONS in sequence, and supporting illustrations. Where applicable, drills are cross-referenced with material in other chapters, other drills, or both. Battle drills are in Section I and crew drills are in Section II. (See ARTEP 7-7J-Drill for the task, conditions, and standards for drill training.)

Section I. BATTLE DRILLS

Field Manual 25-101 defines a battle drill as “a collective action rapidly executed without applying a deliberate decision-making process.” Characteristics of a battle drill are:

- They require minimal orders from leaders and are standard throughout the Army.
- Sequential actions are vital to success in combat or critical to preserving life.
- They apply to platoon or smaller units.
- They are trained responses to enemy actions or leaders' orders.
- They represent mental steps followed for offensive and defensive actions in training and combat.

**Battle Drill 1
REACT TO CONTACT (PLATOON OR SQUAD)
(DISMOUNTED)**

SITUATION: The platoon or squad (dismounted element) receives direct fires from enemy individual or crew-served weapons (physical contact). The dismounted element is operating within the supporting range of the BFVs.

REQUIRED ACTIONS (Figure E-1 and Figure E-2, page E-3):

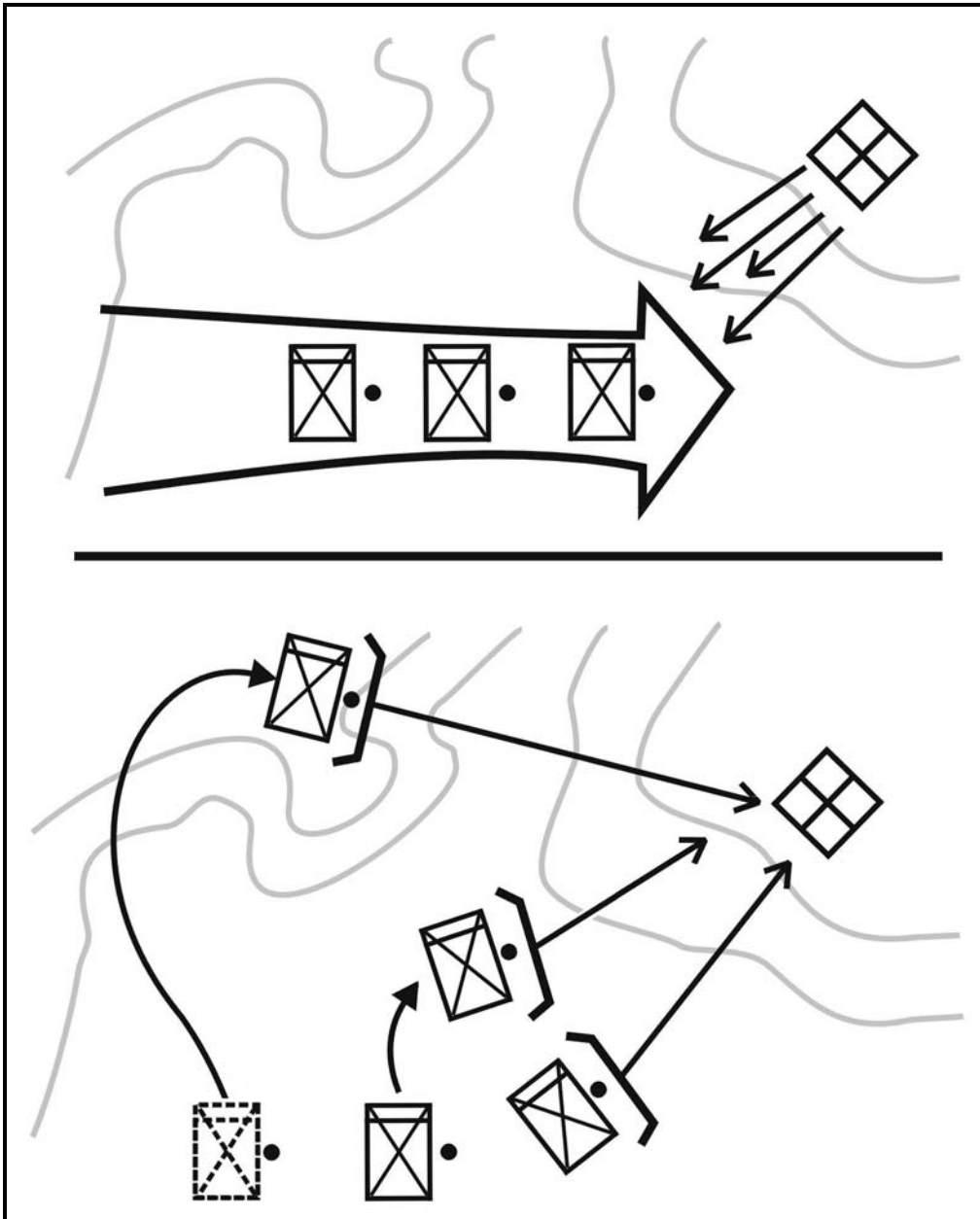

Figure E-1. React to contact (dismounted).

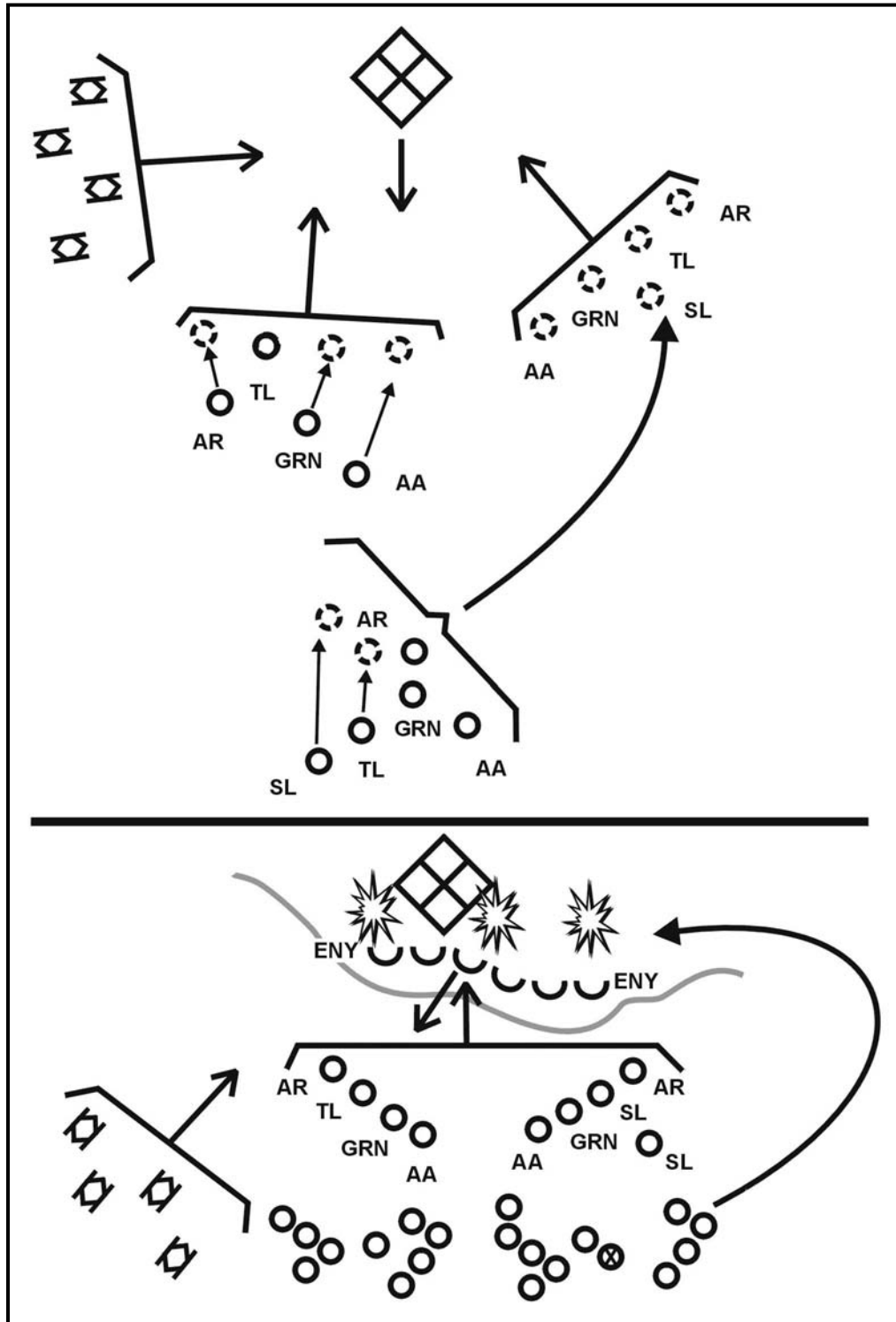

Figure E-2. React to contact (dismounted) (continued).

1. Soldiers immediately assume the nearest covered positions and return fire in the direction of contact.

2. Squad or team leaders locate and engage known or suspected enemy positions with well-aimed fire and pass information to the squad or platoon leader. The platoon leader reports contact to the company commander.

3. Fire team leaders control fire using standard fire commands (initial and supplemental) containing the elements of alert, direction, description of target, range, method of fire (manipulation and rate of fire), and command to commence firing.

4. Soldiers maintain contact (visual or verbal) with the soldiers on their left and right.

5. Soldiers maintain contact with their team leaders and report the location of enemy positions.

6. Leaders (visually or verbally) check the status of their personnel.

7. The squad or team leaders maintain visual contact with the platoon or squad leader.

8. The team leader leads his team by example: "Follow me; do as I do."

9. Leaders relay all commands and signals from the platoon chain of command.

10. The platoon sergeant positions the BFVs as necessary to observe and to provide supporting fires.

NOTE: Once the platoon has executed the React to Contact battle drill, the platoon leader makes a quick assessment of the situation (for example, enemy size, location). He decides on a course of action (Battle Drill 3, Break Contact [Dismounted]). The platoon leader reports the situation to the company commander.

Battle Drill 1A
REACT TO CONTACT (SECTION OR PLATOON)
(MOUNTED)

SITUATION: While mounted, the platoon receives fires from enemy individual or crew-served weapons (including light antiarmor weapons).

NOTE: During mounted operations one rifle squad is split between the BFV sections. When required to conduct dismounted operations and separated from its parent squad the platoon leader or platoon sergeant will normally control the fire team.

REQUIRED ACTIONS (Figure E-3):

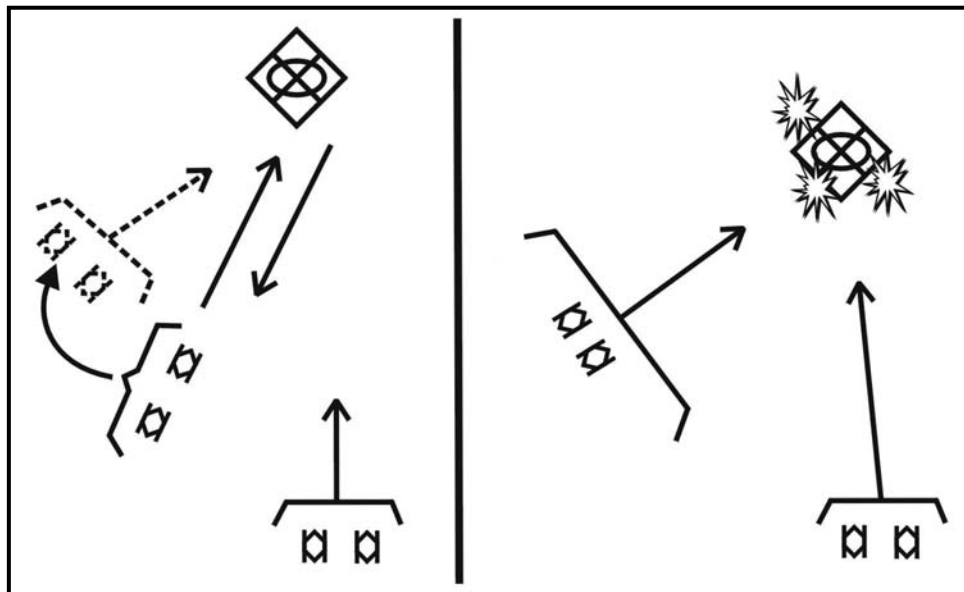

Figure E-3. React to contact (mounted).

1. Vehicles of the section in physical contact with the enemy immediately return fire in the direction of contact while moving out of the beaten zone. The section leader of the section in contact (if not the platoon leader) reports contact to the platoon leader.
2. All vehicles move to the nearest covered and concealed positions.
3. Upon reaching the covered and concealed position, the section in physical contact continues to engage the enemy with well-aimed fire using precision fire command. The squad/fire teams dismount to provide local security and or add suppressive fires against the enemy position.
4. Vehicles of the section not in physical contact orient their weapons in the direction of the enemy.
5. The platoon leader or platoon sergeant reports contact to the company commander.

NOTE: Once the platoon has executed the React to Contact drill, the platoon leader makes a quick assessment of the situation (for example, enemy size, location). He decides on a course of action. The platoon leader may elect to bypass, if permitted by the company commander. The platoon leader reports the situation to the company commander.

6. Bradley commanders within a section maintain visual contact with each other (wingman concept).
7. Bradley commanders maintain communications with the platoon leader.
8. Bradley commanders relay all commands to mounted infantry fire teams.

Battle Drill 2
BREAK CONTACT (PLATOON OR SQUAD)
(DISMOUNTED)

SITUATION: The platoon or rifle squad(s) (dismounted element) is under enemy fire and must break contact. The dismounted element is operating within supporting range of the BFVs.

REQUIRED ACTIONS (Figure E-4 and Figure E-5, page E-8):

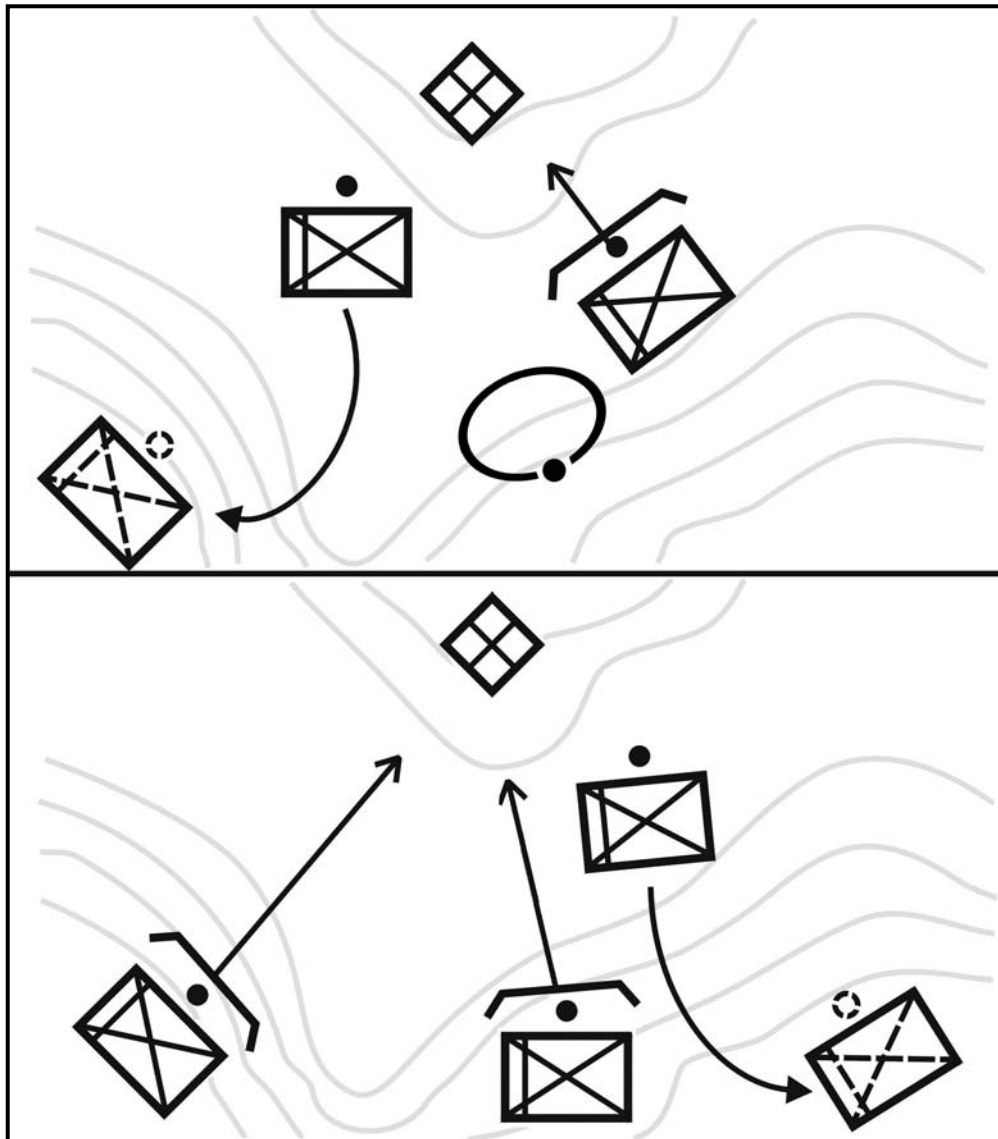

Figure E-4. Break contact (dismounted).

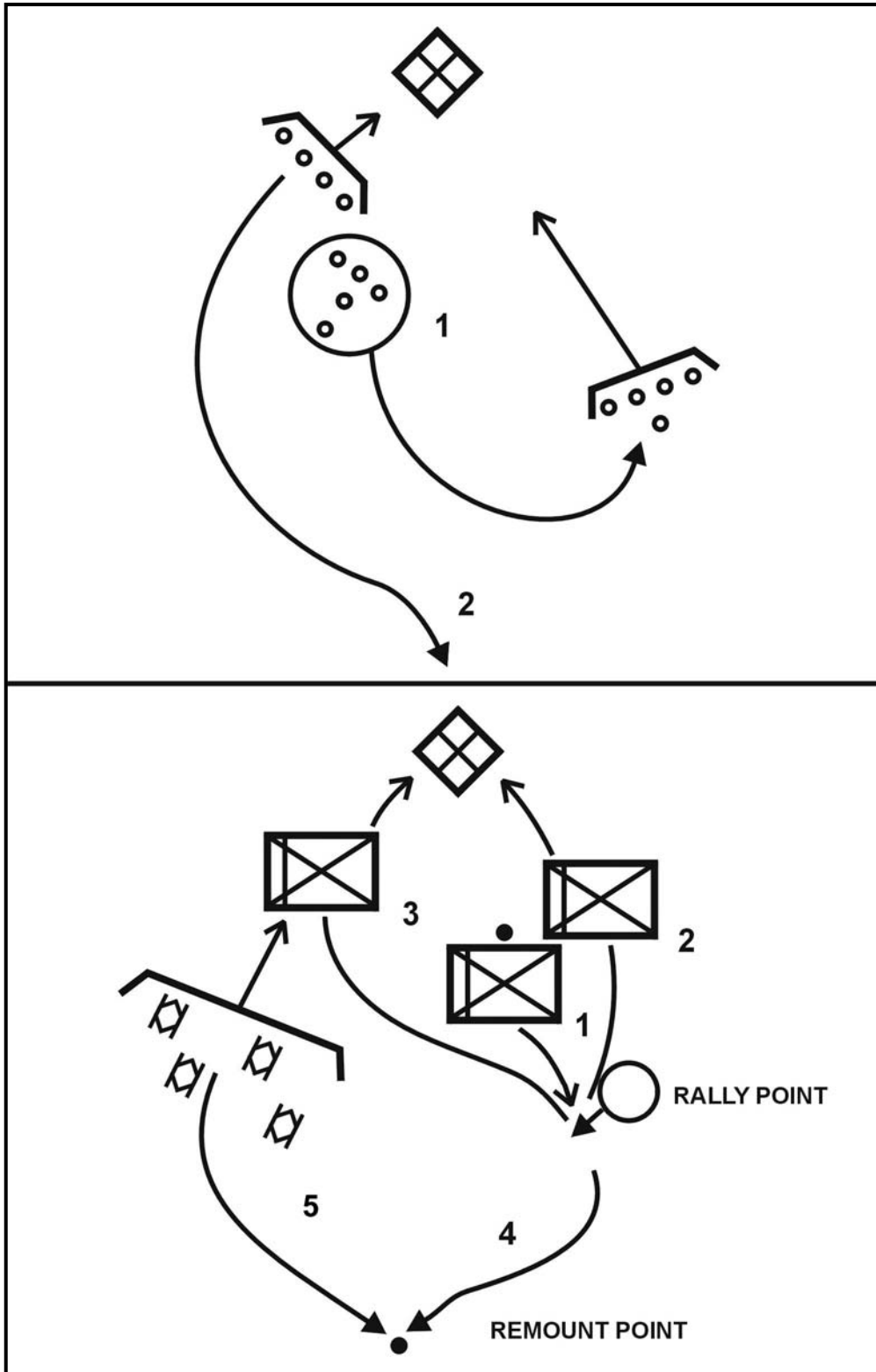

Figure E-5. Break contact (dismounted) (continued).

1. The platoon leader gives the order to break contact.
2. The platoon leader directs the BFVs to support the disengagement of the dismounted element. (If the BFVs cannot support the disengagement of the dismounted element, the platoon/squad leader directs a squad or squads/fire team to suppress by fire to support the disengagement of the remainder of the element.
3. The platoon or squad leader orders a distance and direction, a terrain feature, or the last objective rally point for the movement of the first squad or fire team.
4. The base-of-fire element (BFVs or squad(s) or fire team) increases the rate of fire to suppress the enemy.
5. The maneuver element moves to assume the overwatch position. The maneuver element uses fragmentation or concussion to break contact, and smoke grenades to screen its movement.
6. The maneuver element takes up the designated position and engages the enemy position.
7. The platoon/squad leader directs the initial base-of-fire element (BFVs or squad(s) or fire team) to move to its/their next location. (Based on the terrain and the volume and accuracy of the enemy's fire, the maneuvering squad(s) or fire team may need to use fire and movement techniques.)
8. The platoon or squad continues to bound away from the enemy until (the platoon or squad must continue to suppress the enemy as it breaks contact)—
 - It breaks all contact.
 - It passes through a higher level base-of-fire position.
 - Its squads or fire teams are in the assigned position to conduct the next mission.
9. In the absence of a leader's instructions, the platoon or squad moves to the last designated rally point.
10. The platoon leader directs the BFVs to move to a rally point and link up with the dismounted element.
11. Section and squad leaders account for soldiers, report, reorganize as necessary and continue the mission.
12. The platoon leader reports the situation to the company commander.

**Battle Drill 2A
BREAK CONTACT (SECTION OR PLATOON)
(MOUNTED)**

SITUATION: The platoon is mounted (except for security elements). It is under enemy fire and must break contact.

REQUIRED ACTIONS (Figure E-6).

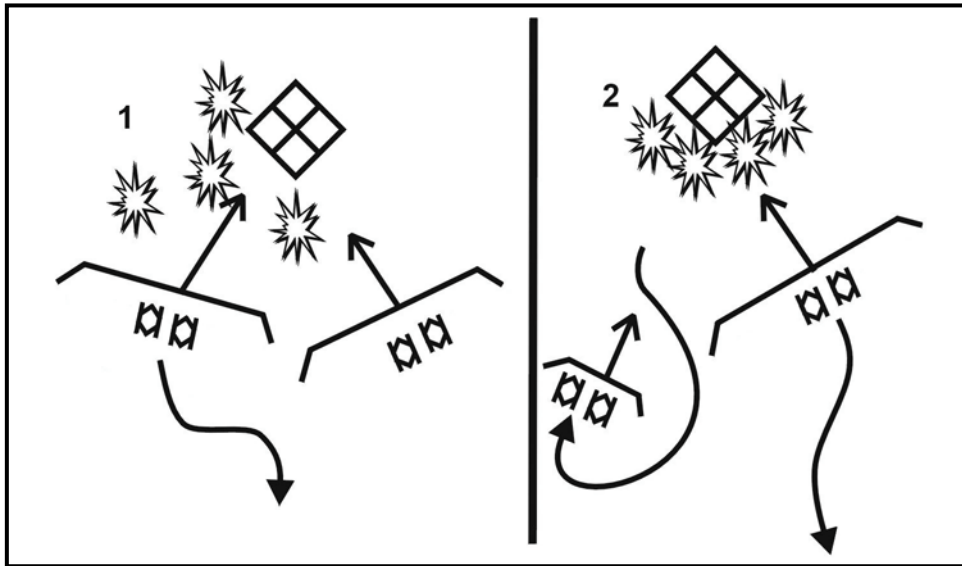

Figure E-6. Break contact (mounted).

1. The platoon leader gives the order to break contact.
2. The platoon leader directs one section to be the base-of-fire element to support the disengagement of the other section.
3. The platoon leader orders a distance and direction, a terrain feature, or last objective rally point for the moving section.
4. The base-of-fire section continues to engage the enemy. It attempts to gain suppressive fire long enough to support the bound of the moving element. (The platoon uses all available direct and indirect fires, including smoke to assist in disengaging.) The section leader controls fires using standard fire commands containing the alert, direction, description of target, range, method of fire, and command to commence firing.
5. The moving section's security element remounts.
6. The moving section continues to fire while moving to an overwatch position and continues to provide suppressive fires. Firing port weapons are manned and ready to fire.
7. The platoon leader directs the supporting section to move to its next location.
8. The platoon continues to bound away from the enemy (suppressing the enemy as it breaks contact) until—
 - It breaks all contact.
 - It passes through a higher level base-of-fire position.
 - Its sections are in the assigned position to conduct the next mission.

9. In the absence of a leader's instructions, the platoon moves to the last designated rally point.

10. Section and squad leaders account for soldiers, report, reorganize as necessary, and continue the mission.

11. The platoon leader reports the situation to the company commander.

Battle Drill 3
REACT TO AMBUSH (PLATOON OR SQUAD)
(DISMOUNTED)

SITUATION: If the platoon or rifle squad(s) (dismounted element) enters a kill zone, and the enemy initiates an ambush with a casualty-producing device and a high volume of fire, the rifle squad or platoon takes the following actions.

REQUIRED ACTIONS (Figure E-7):

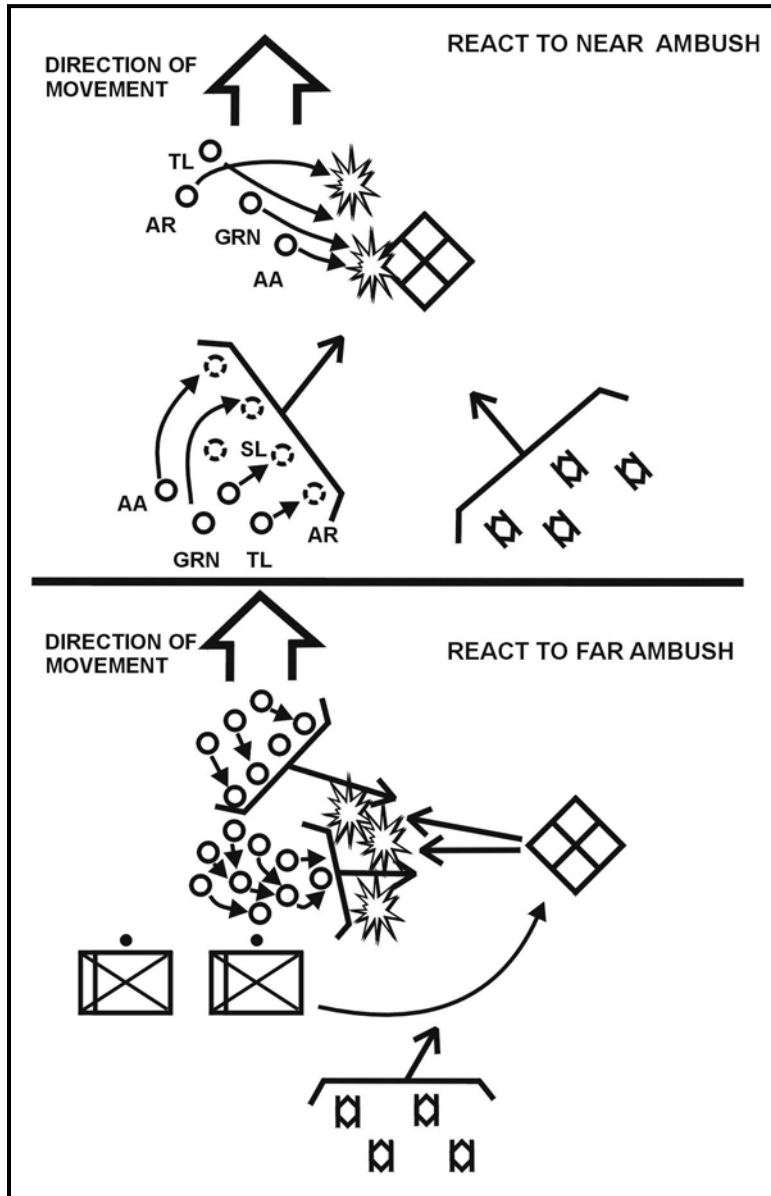

Figure E-7. React to ambush (dismounted).

1. In a near ambush (within hand-grenade range), soldiers receiving fire immediately return fire; take up covered or assume prone positions; throw fragmentation, concussion, and smoke grenades.
 - a. Immediately after the grenades detonate, soldiers in the kill zone assault through the ambush using fire and movement.
 - b. BFVs and soldiers not in the kill zone immediately—
 - Identify enemy positions.
 - Initiate immediate suppressive fires against the enemy.
 - Shift fires as the soldiers in the kill zone assault through the ambush.
2. In a far ambush (beyond hand-grenade range), soldiers receiving fire immediately return fire, take up covered positions, and suppress the enemy by—
 - Destroying or suppressing enemy crew-served weapons.
 - Obscuring the enemy position with smoke (M203).
 - Sustaining suppressive fires.
 - a. Soldiers (squads or teams) not receiving fires move by a covered and concealed route to an assailable flank of the enemy position and assault using fire and movement techniques.
 - b. BFVs and soldiers in the kill zone continue suppressive fires and shift fires as the assaulting squad(s) or team fights through the enemy position.
 - c. The platoon leader directs the vehicles to move to positions where they can place effective fires on the enemy or the platoon leader conducts a flank attack, if he determines that there are no antitank weapons in the ambush.
3. The platoon leader/sergeant calls for and adjusts indirect fires. On order, he shifts fires to isolate the enemy position or to attack them with indirect fires as they retreat.
4. The platoon or squad leader reports, reorganizes as necessary, and continues the mission.

**Battle Drill 3A
REACT TO AMBUSH (PLATOON)
(MOUNTED)**

SITUATION: If the platoon is mounted, enters a kill zone, and the enemy initiates an ambush with a light antiarmor weapon and a high volume of fire, the platoon takes the following action.

REQUIRED ACTIONS (Figure E-8):

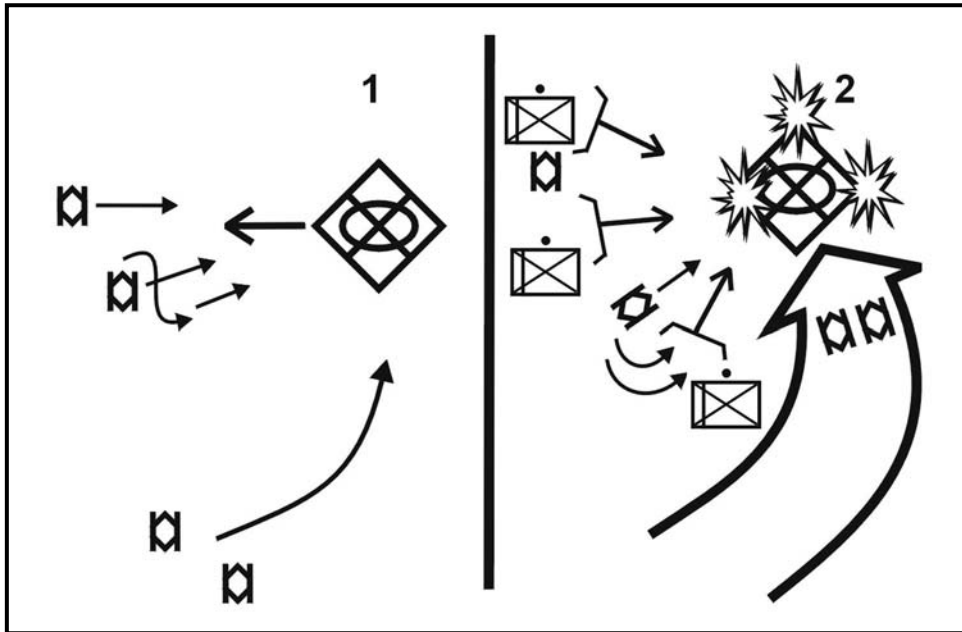

Figure E-8. React to ambush (mounted).

1. Vehicles in the section in the kill zone immediately return fire, while moving out of the kill zone or to covered positions within the kill zone and continue to fire on the ambush position with the highest possible volume of fire.

2. Soldiers in disabled vehicles in the kill zone dismount immediately, assume covered and concealed positions, and add their suppressive fires against the enemy.

3. The section in the kill zone gains suppressive fire.

a. Destroys or suppresses enemy weapons firing most effectively against the section.

b. Obscures the enemy position with smoke.

c. Sustains suppressive fires.

d. The section not in the kill zone moves by a covered and concealed route to an assailable flank of the enemy position and assaults across the enemy position mounted. (Battle Drill 1 or 1A.)

e. BFVs and soldiers in the kill zone continue suppressive fires and shift fires as the assaulting section fights through the enemy position.

4. The platoon leader/sergeant calls for and adjusts indirect fires. On order or as required, he shifts fires to isolate the enemy position, or to attack them with indirect fires as they retreat.

5. The platoon leader/sergeant reports, reorganizes as necessary, and continues the mission. (If the platoon cannot continue the assault, it breaks contact. See Battle Drill 3A, Break Contact [Mounted].)

Battle Drill 4
ENTER BUILDING/CLEAR ROOM/BUILDING
(PLATOON)

SITUATION: Operating as part of a larger force, the platoon is moving (mounted or dismounted) and is operating within supporting range of the BFVs when it receives fire from the enemy in a building.

NOTE: The battle drill assumes that only the platoon's organic weapons support the rifle squad(s). Some urban operations (UO) situations may require precise application of firepower. This is true of a UO environment where the enemy is mixed with noncombatants. The presence of civilians can restrict the use of fires and reduce the combat power available to a platoon leader. His platoon may have to operate in "no fire" areas. Rules of engagement (ROE) can prohibit the use of certain weapons until a specific hostile action takes place. The use of hand grenades and suppressive fire to enter rooms may be prohibited to preclude noncombatant casualties and collateral damage. All leaders must be aware of the ROE. They must include the precise use of weapons in their planning for missions during UO. This includes how the platoon will employ its organic weapons and other weapon systems it may have in support. They must coordinate the use of marking systems to prevent casualties due to friendly fire. FM 3-06.11 provides additional techniques for platoons and squads in UO.

REQUIRED ACTIONS (Figure E-9 and Figure E-10, page E-18):

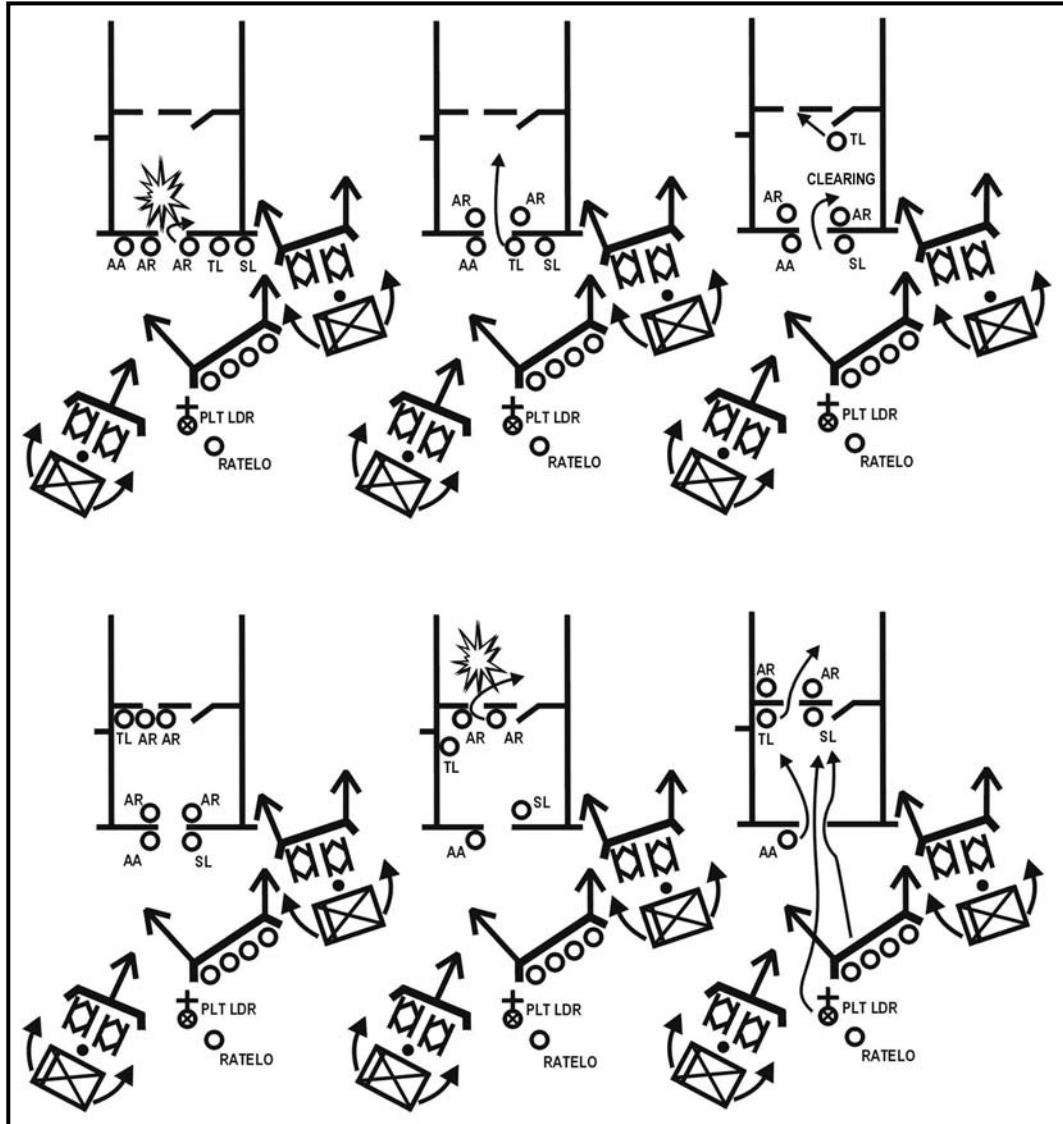

Figure E-9. Enter and clear a building (platoon).

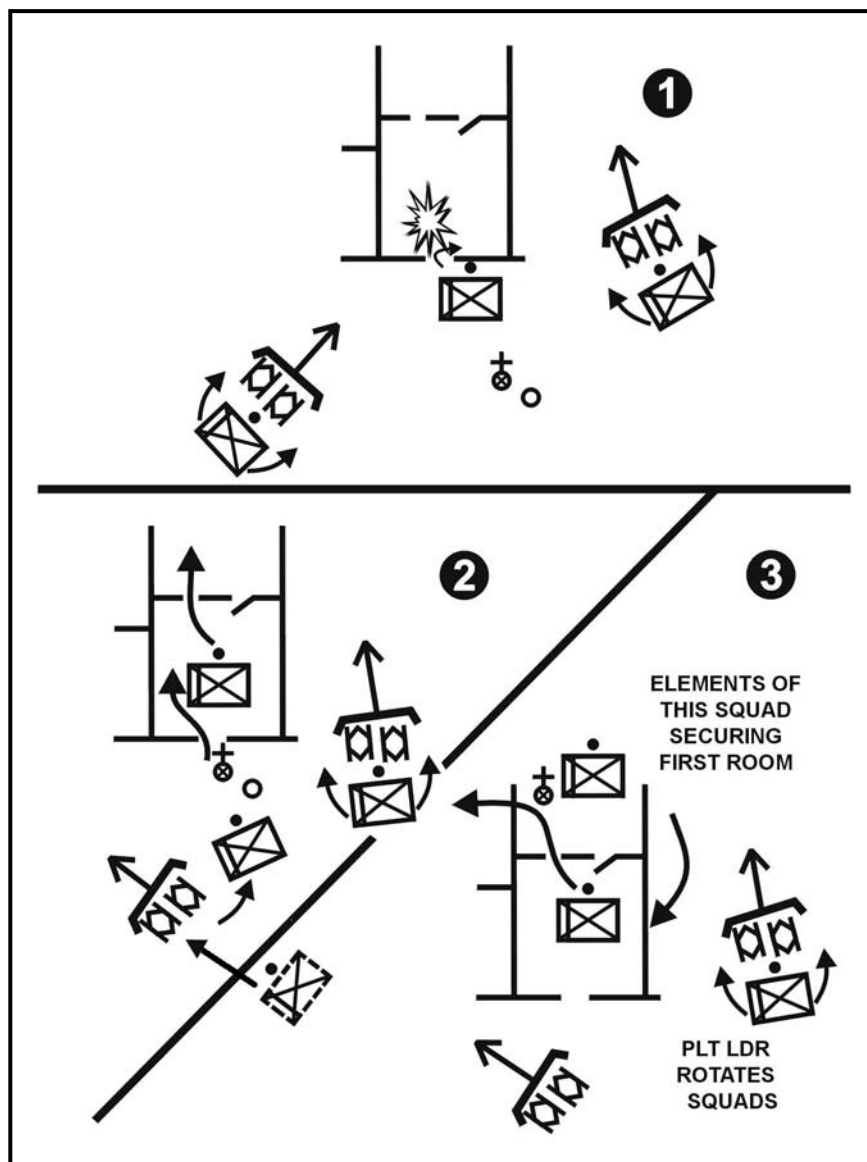

Figure E-10. Enter a building and clear a room (squad).

1. The section or squad in physical contact reacts to contact.
2. The platoon places suppressive fires against the enemy.
 - a. The section or squad in physical contact establishes a base of fire. If mounted, the squad/fire teams dismount, establish local security, and add their suppressive fires against the enemy. If dismounted, the platoon leader, his RATELO, and squad leaders of squads not in physical contact move forward to link up with the squad leader of the squad in contact.
 - b. The platoon sergeant repositions the BFVs, if necessary, to provide additional observation and supporting fires against the enemy.
3. The platoon leader determines that he can maneuver by identifying—
 - The building and any obstacles.

- The size of the enemy force engaging the platoon.
 - An entry point. (Assaulting squad should enter the building at the highest level possible.)
 - A covered and concealed route to the entry point.
4. The base-of-fire element (the BFVs and the squad(s) in contact)—
 - Destroys or suppresses enemy weapons that are firing most effectively against the assaulting squad.
 - Obscures the enemy position with smoke (M203).
 - Sustains suppressive fires.
 5. The platoon leader designates the entry point of the building and directs one squad to enter the building and secure a foothold.
 6. The squad leader directs the fire team in contact to support the entry of the other fire team into the building.
 7. If necessary, the base-of-fire element repositions to isolate the building as well as continue suppressive fires. (Normally, the platoon has added its supporting fires against the enemy.)
 8. The squad leader designates the entry point of the building. The platoon and squad shift direct fires and continue to suppress the enemy in adjacent positions and to isolate the building. The platoon leader/sergeant shifts indirect fires away from the building.
 9. The squad leader and the assaulting fire team approach the building and position themselves at either side of the entrance. Soldiers should avoid entering buildings through doors and windows, because enemy weapons inside the building will likely cover these entry points.
 10. Allowing cook-off time (two seconds maximum), and shouting FRAG OUT, the lead soldier of the assaulting fire team prepares and throws a grenade into the building.

NOTE: Some construction of walls and floors will not provide sufficient protection from hand grenade fragmentation. In these instances, concussion grenades may be better suited.

11. After the explosion, the next soldier enters the building and positions himself to the right (left) of the entrance, against the wall, engages all identified or likely enemy positions with rapid, short bursts of automatic fire, and scans the room. The rest of the team provides immediate security outside the building.

a. The size and shape of the room may cause the soldier entering the room to move to the left or right. The first soldier in the room decides where the next man should position himself and gives the command NEXT MAN IN, LEFT (or RIGHT). The next man shouts COMING IN, LEFT (RIGHT), enters the building, positions himself to the left of the entrance, against the wall, and scans the room. Once in position, he shouts NEXT MAN IN (RIGHT or LEFT).

b. Depending on the enemy's situation, the size of the entry and the training of the squad, two soldiers can enter the room simultaneously after the grenade detonates. The soldier from the right side of the entry enters, fires from left to right, and moves to the right with his back to the wall. At the same time, the soldier on the left enters from the left, fires from right to left, and moves to the left with his back to the wall. One soldier

goes high, the other low, to prevent firing at one another. This method puts more firepower in the room more quickly, but is more difficult and requires more practice. When both soldiers are in position, the senior soldier gives the command NEXT MAN IN (RIGHT or LEFT).

12. The assaulting fire team leader shouts COMING IN (RIGHT or LEFT), enters the building initially moving left or right and against the wall, and positions himself where he can control the actions of his team. He does not block the entrance. He makes a quick assessment of the size and shape of the room, and begins to clear the room. He determines if the remaining man in his team is required to assist in clearing the room.

a. If the team leader decides to bring the last man in, he shouts NEXT MAN IN LEFT (or RIGHT). The last man in the fire team shouts COMING IN LEFT (or RIGHT), enters the building and begins to clear through the room.

b. If the team leader decides not to bring the last man in, he shouts NEXT MAN, STAND FAST. The last man remains outside the building and provides security from there. The team leader then directs the soldier on the right of the entrance to begin clearing. The team leader reports to the squad leader and then assumes the duties of the soldier on the right of the entrance to provide support.

13. Once the room is cleared, the team leader signals to the squad leader that the room is cleared.

14. The squad leader enters the building and marks the entry point in accordance with the unit SOP. The squad leader determines whether or not his squad can continue to clear rooms and still maintain suppressive fires outside the building (Normally, the platoons will suppress enemy in buildings with the BFVs). Platoons (as a minimum) clear a building.

15. The squad leader and assaulting fire team move to the entrance of the next room to be cleared and position themselves on either side of the entrance. The squad enters and clears all subsequent rooms by repeating the actions discussed in paragraphs 8 through 12.

16. The squad leader directs the team to continue and clear the next room. The squad leader rotates fire teams as necessary to keep the soldiers alert, to equitably distribute the dangerous duties, and to continue the momentum of the attack.

17. The squad leader follows the fire team that is clearing to ensure that cleared rooms are properly marked in accordance with the platoon SOP.

18. The squad leader assesses the situation to determine if he can continue clearing the building. He reports the situation to the platoon leader. The platoon follows the success of the entry into the building.

19. The squad consolidates its position in the building and then reorganizes as necessary, and continues the mission.

20. The platoon leader moves into the building with the trail fire team of the squad that entered the building and directs the squad to continue to clear the building or calls for one of the squads not in contact to move into the building and begin clearing rooms systematically. The platoon clears the building by repeating the actions discussed in paragraphs 8 through 12 until all rooms have been cleared.

21. The platoon leader rotates squads as necessary to keep his men fresh and to maintain the momentum of the action.

22. The base-of-fire element—
 - Repositions, if necessary, to continue to isolate and suppress the building from the outside.
 - Ensures that all friendly forces enter the building only through the designated entry point.
23. The platoon sergeant calls forward ammunition resupply and organizes teams to move it forward into the building.
24. The platoon leader reports to the company commander that his platoon has cleared the building or that he is no longer able to continue clearing.

**Battle Drill 5
ENTER/CLEAR A TRENCH (PLATOON)**

SITUATION: The platoon is attacking as part of a larger force and identifies enemy in a trench line. The platoon deploys and establishes a base of fire. The platoon leader determines that he has sufficient combat power to maneuver and assault the trench line.

REQUIRED ACTIONS (Figure E-11, Figure E-12, and Figure E-13, page E-24):

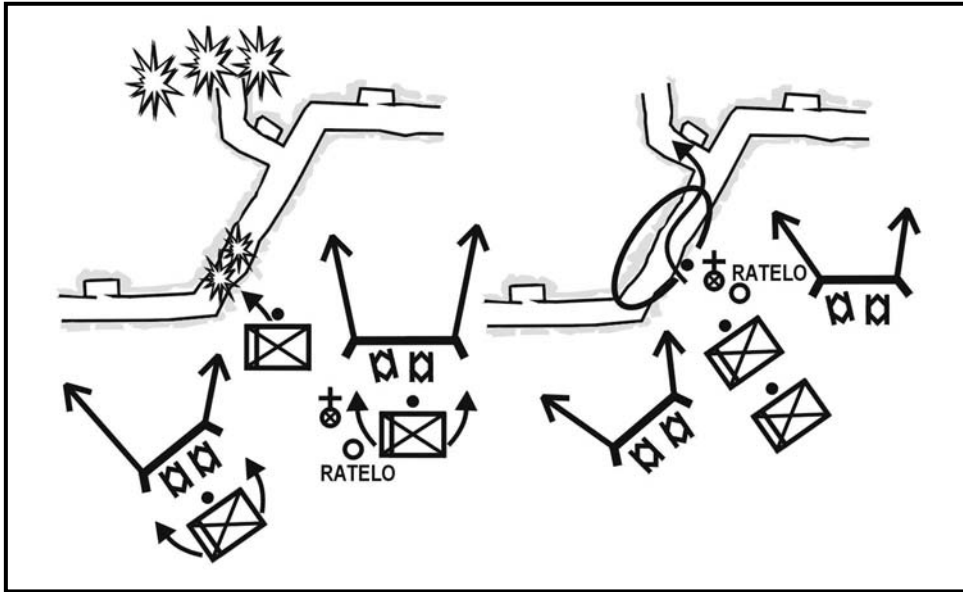

Figure E-11. Clear a trench line (platoon).

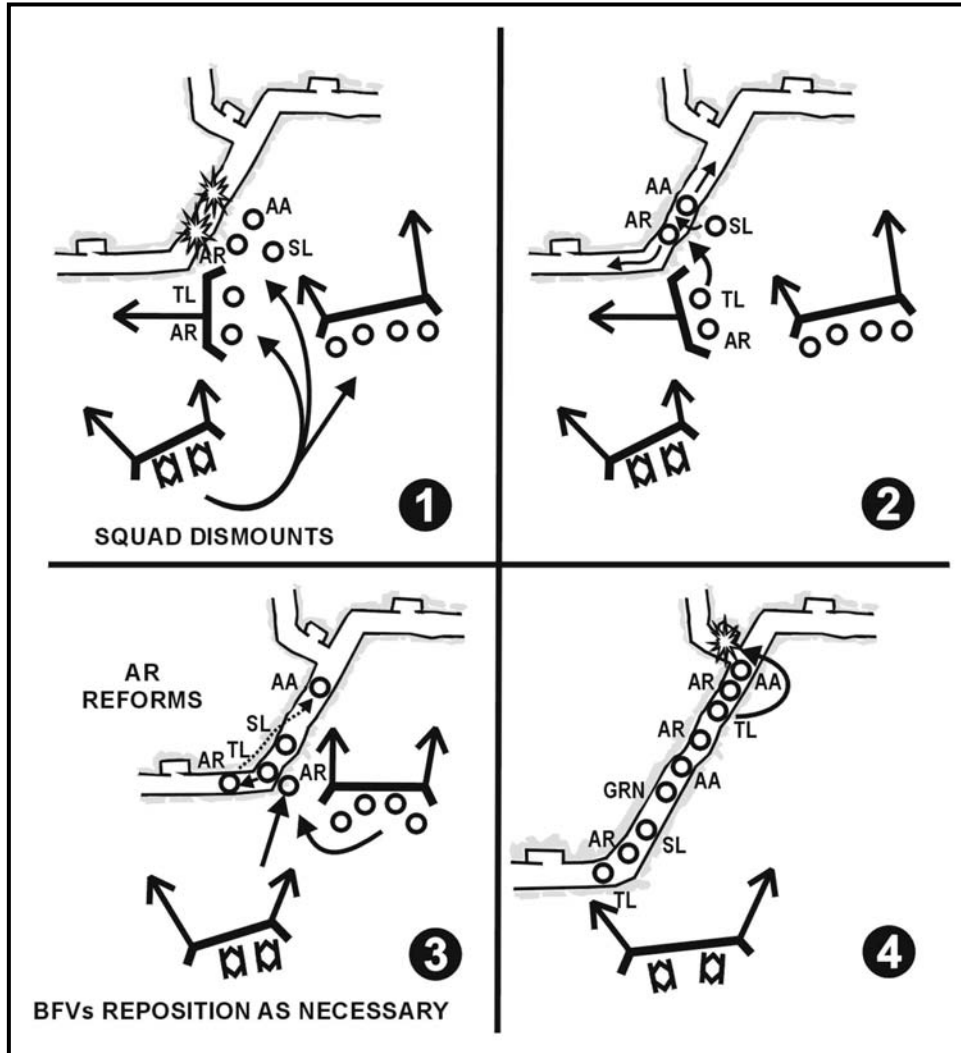

Figure E-12. Enter a trench line (squad).

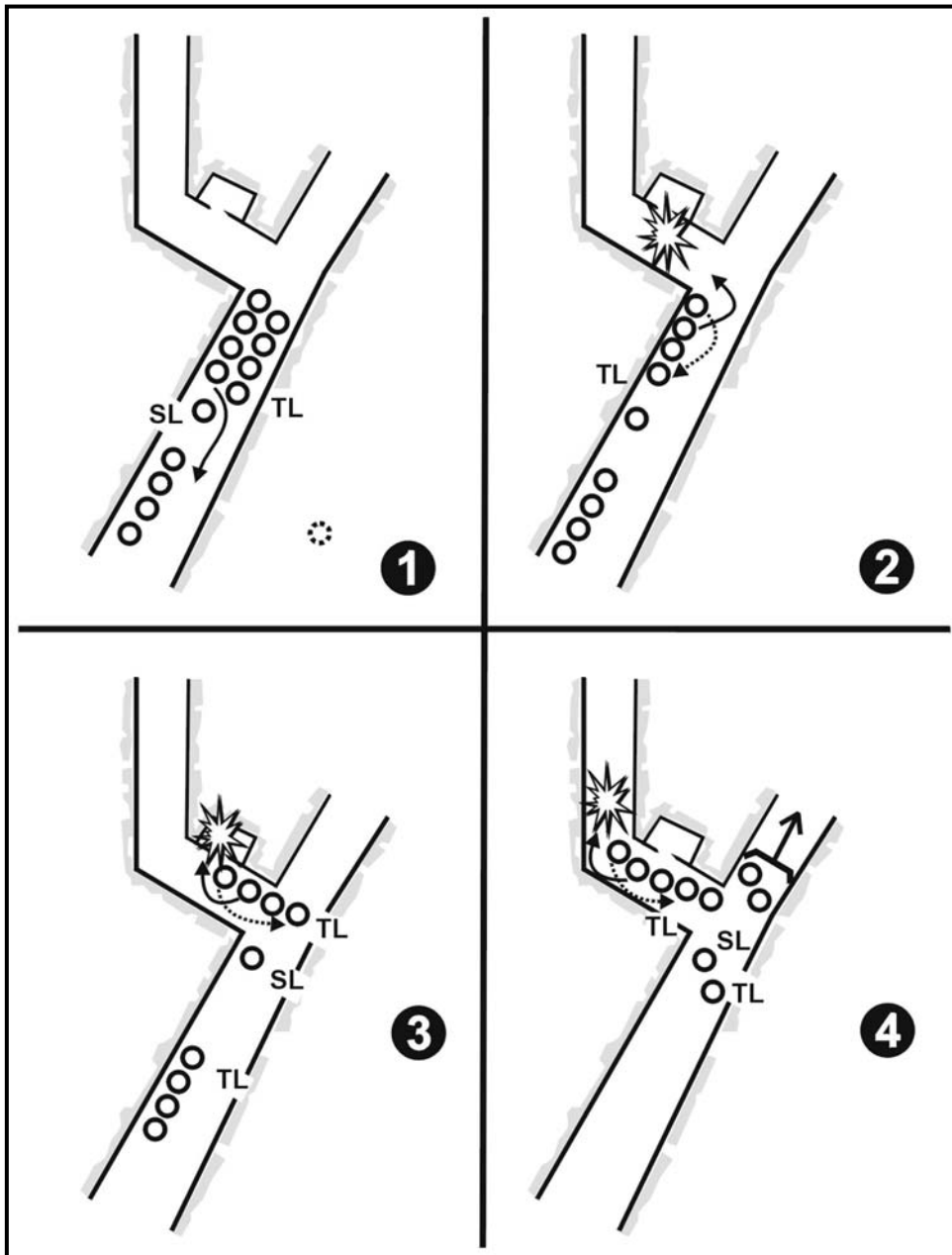

Figure E-13. Clear a trench line (squad).

1. The platoon leader directs one squad to enter the trench and secure a foothold.
2. The platoon leader designates the entry point of the trench line and the direction of movement once the platoon begins clearing.
3. The platoon sergeant positions BFVs to isolate the entry point and to suppress enemy in the trench.
4. The assaulting squad executes actions to enter the trench and establish a foothold. The squad leader directs one fire team to assault and one fire team to support by fire.

initially, then follow and support the assaulting fire team. He designates the entry point of the trench line.

a. The squad leader and the assault fire team move to the last covered and concealed position short of the entry point.

(1) The squad leader marks the entry point.

(2) The base-of-fire element (BFVs and remaining squads) shifts direct fires away from the entry point and continues to suppress adjacent enemy positions or isolate the trench segment as required.

(3) The assault fire team leader and the automatic rifleman remain in a position short of the trench to add suppressive fires for the initial entry.

(4) The squad leader takes the two remaining soldiers of the assault fire team (automatic rifleman and rifleman/antiarmor specialist) and continues toward the entry point. They move in rushes or by high/low crawling.

(5) The squad leader positions himself where he can best control his fire teams.

b. The first two soldiers (rifleman/antiarmor specialists and automatic rifleman) of the assaulting fire team move to the edge of the trench; parallel to the trench, and on their backs and feet to feet; on the squad leader's command, cook-off grenades (two seconds maximum), shout FRAG OUT, and throw the grenades into the trench.

(1) After ensuring that both grenades detonate, the soldiers roll into the trench, landing on their feet, and back-to-back. They fire their weapons down the trench in opposite directions. Immediately, both soldiers move in opposite directions down the trench, continuing to fire three-round bursts. Each soldier continues until he reaches the first corner or intersection. Both soldiers halt and take up positions to block any enemy movement toward the entry point.

(2) At the same time, the squad leader rolls into the trench and secures the entry point.

(3) Upon detonation of the grenades, the assaulting fire team leader and the automatic rifleman immediately move to the entry point and enter the trench. The squad leader directs them to one of the secured corners or intersections to relieve the rifleman/antiarmor specialist or automatic rifleman who then rejoins his buddy team at the opposite end of the foothold.

c. The squad leader remains at the entry point and marks it.

d. The squad leader reports to the platoon leader that he has entered the trench and secured a foothold. The platoon follows the success of the seizure of the foothold with the remainder of the rifle squads as part of the platoon actions to clear a trench line.

e. The squad reorganizes as necessary. Leaders redistribute ammunition.

5. The platoon leader directs a squad that is not in contact to move into the trench and begin clearing it in the direction of movement from the foothold.

6. The base-of-fire element repositions as necessary to continue suppressive fires.

7. The platoon leader moves into the trench with the new assaulting squad.

8. The assaulting squad passes the squad that has secured the foothold and executes actions to take the lead and clear the trench.

a. The squad leader designates a lead fire team and a trail fire team.

b. The lead fire team and the squad leader move to the forward-most secure corner or intersection. The squad leader tells the fire team securing that corner or intersection that his squad is ready to continue clearing the trench. The trail fire team follows

maintaining visual contact with the last soldier of the lead team. Fire teams should maintain a sufficient interval to prevent them from being engaged by the same enemy weapon system.

NOTE: Throughout this technique, the team leader positions himself at the rear of the fire team to have direct control (physically, if necessary) of his soldiers. Other soldiers in the fire team rotate the lead. Soldiers rotate the lead to change magazines and prepare grenades. Rotating the lead provides constant suppressive fires down the trench and maintains the momentum of the attack as the squad clears the trench.

c. The lead fire team passes the element securing the foothold.

(1) The lead soldier of the fire team moves abreast of the soldier securing the corner or intersection, taps him, and announces **TAKING THE LEAD**.

(2) The soldier securing the corner or intersection acknowledges that he is handing over the lead by shouting **OKAY**. He allows the fire team to pass him.

d. The lead fire team starts clearing in the direction of movement. They arrive at a corner or intersection.

(1) Allowing for cook-off (two seconds maximum) and shouting **FRAG OUT**, the second soldier prepares and throws a grenade around the corner.

(2) Upon detonation of the grenade, the lead soldier moves around the corner firing three-round bursts and advancing as he fires. The entire fire team follows him to the next corner or intersection.

e. The squad leader—

(1) Follows immediately behind the lead fire team.

(2) Ensures that the trailing fire team moves up and is ready to pass the lead at his direction.

(3) Rotates fire teams as necessary to keep his soldiers alert and to maintain the momentum of the attack.

(4) Requests indirect fires, if necessary, through the platoon leader. (The squad leader also directs the employment of the M203 to provide immediate suppression against enemy positions along the trench line.)

f. At each corner or intersection, the lead fire team performs the same actions described in paragraph d.

g. If the lead soldier finds that he is nearly out of ammunition before reaching a corner or intersection, he announces **AMMO**.

(1) Immediately, the lead soldier stops and moves against one side of the trench, ready to let the rest of the fire team pass. He continues to aim his weapon down the trench in the direction of movement.

(2) The next soldier ensures that he has a full magazine, moves up abreast of the lead soldier, taps him and announces **TAKING THE LEAD**.

(3) The lead soldier acknowledges that he is handing over the lead by shouting **OKAY**, positions rotate, and the squad continues forward.

h. The trailing fire team secures intersections and marks the route within the trench as the squad moves forward. The trailing fire team leader ensures that follow-on squads relieve his buddy teams as security to maintain combat power.

i. The squad leader reports the progress of the clearing operation. (The base-of-fire element must be able to identify the location of the lead fire team in the trench at all times.)

9. The platoon leader rotates squads to keep soldiers alert and to maintain the momentum of the assault.

10. The platoon sergeant calls forward ammunition resupply and organizes teams to move it forward into the trench.

11. The base-of-fire element ensures that all friendly forces move into the trench **ONLY** through the designated entry point. (All movement must be made in the trench to avoid fratricide.)

12. The platoon leader reports to the company commander that the trench line is secured, or that he is no longer able to continue clearing.

Battle Drill 6 KNOCK OUT BUNKERS (PLATOON)

SITUATION: The platoon receives fire from enemy in bunkers while moving (mounted or dismounted) as a part of a larger force and dismounted element is required to clear the bunkers.

REQUIRED ACTIONS (Figures E-14 and E-15):

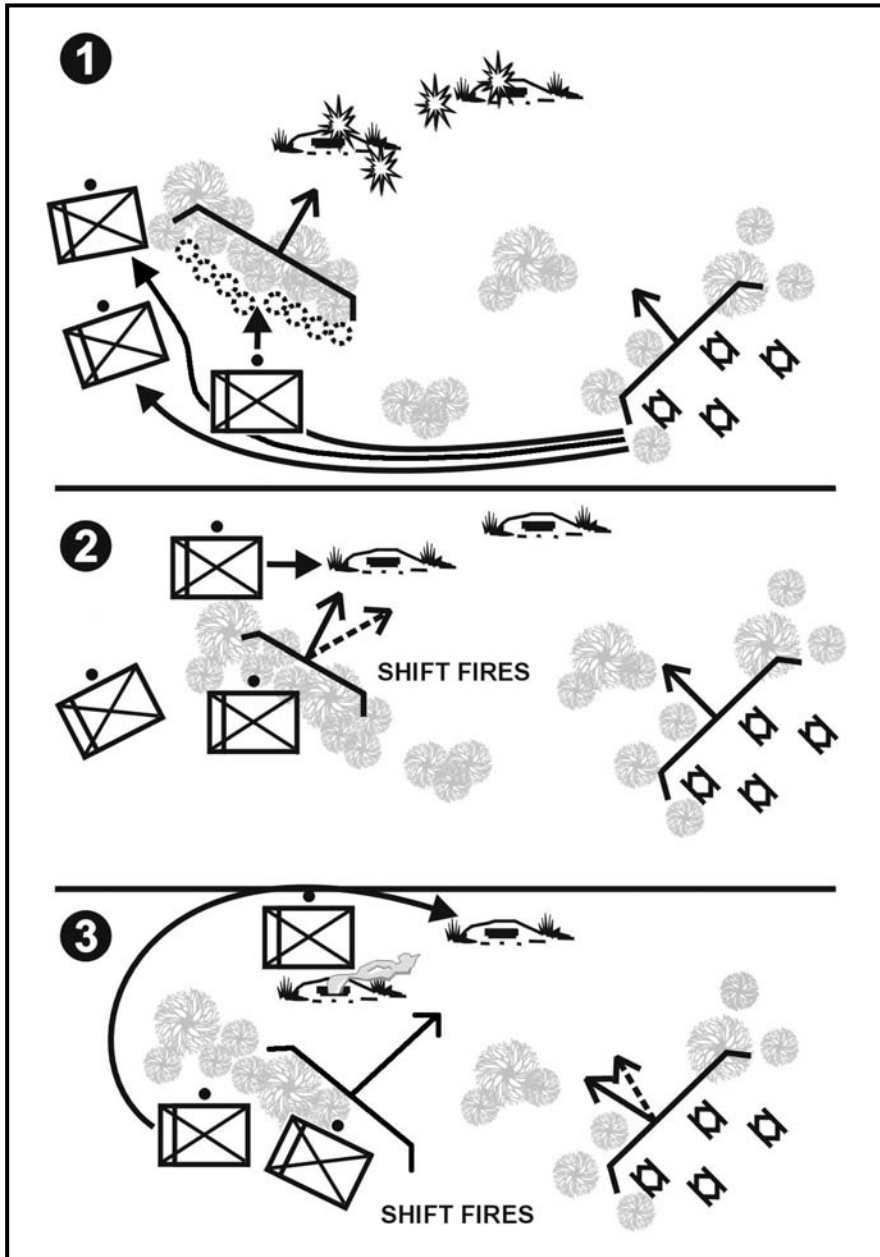

Figure E-14. Knock out bunkers (platoon).

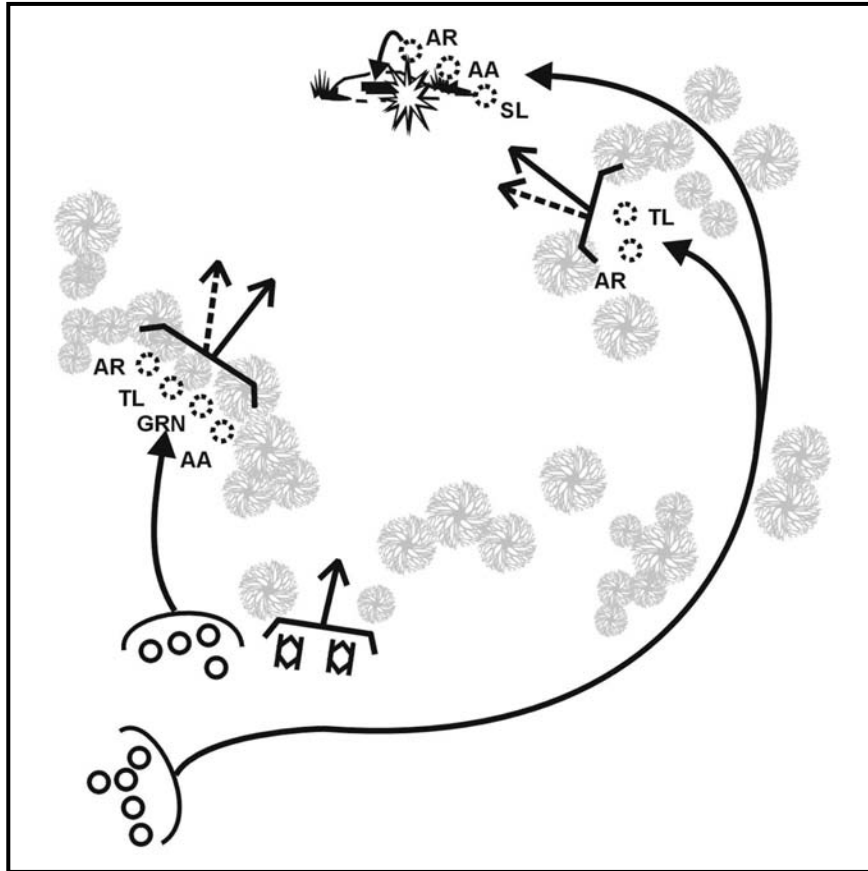

Figure E-15. Knock out bunkers (squad).

1. The section or squad in contact reacts to contact.
2. The platoon places suppressive fires on the enemy.
 - a. The section or squad in contact establishes a base of fire.
 - b. If mounted, the squad/fire teams dismount, establishes local security, and adds its suppressive fires against the enemy. The platoon leader and his RATELO dismount and if not the lead section, move forward with the other squad leaders and link up with the squad leader of the squad in contact. If dismounted, the platoon leader, his RATELO, and the squad leaders of the squads not in contact move forward to link up with the squad leader of the squad in contact.
 - c. The platoon sergeant repositions the BFVs, if necessary, to provide additional observation and base of fire.
 - d. The base-of-fire element (the BFVs and the squad(s) in contact)—
 - Destroys or suppresses enemy crew-served weapons first.
 - Obscures the enemy position with smoke (M203).
 - Sustains suppressive fires.
 - e. The platoon leader/sergeant calls for and adjusts indirect fires.
3. The platoon leader determines that he can maneuver by identifying—
 - The enemy bunkers, other supporting positions, and any obstacles.

- The size of the enemy force engaging the platoon. (The number of enemy automatic weapons, the presence of any vehicles, and the employment of indirect fires are indicators of enemy strength.)
 - An assailable flank of at least one bunker.
 - A covered and concealed flanking route to the flank of the bunker.
4. The platoon leader determines which bunker is to be assaulted first and directs a squad not in contact to knock it out.
 - a. The platoon leader/sergeant shifts indirect fires to isolate enemy positions.
 - b. On the platoon leader's signal, the base-of-fire element shifts fires to the opposite side of the bunker from which the squad is assaulting.
 5. The assaulting squad, with the platoon leader and his RATELO, move along the covered and concealed route and take action to knock out the bunker.
 - a. The squad leader moves with the assaulting fire team along the covered and concealed route to the flank of the bunker.
 - (1) The assaulting fire team approaches the bunker from its blind side and does not mask the fires of the base-of-fire element.
 - (2) Soldiers constantly watch for other bunkers or enemy positions in support of it.
 - b. Upon reaching the last covered and concealed position--
 - (1) The fire team leader and the automatic rifleman remain in place and add their fires to suppressing the bunker (includes the use of AT4s).
 - (2) The squad leader positions himself, where he can best control his teams. On the squad leader's signal, the base-of-fire element shifts fires to the opposite side of the bunker from the assaulting fire team's approach.
 - (3) The squad leader continues forward with the automatic rifleman and rifleman/antiarmor specialist to the blind side of the bunker. One soldier takes up a covered position near the exit, while one soldier cooks off (two seconds maximum) a grenade, shouts FRAG OUT, and throws it through an aperture.
 - (4) After the grenade detonates, the soldier covering the exit enters the bunker, firing short bursts, to destroy the enemy. The soldier who throws the grenade should not be the first one to clear the bunker.
 - c. The squad leader inspects the bunker to ensure that it has been destroyed. He reports, reorganizes as needed, and continues the mission. The platoon follows the success of the attack against the bunker and continues the attack of other bunkers (if present).
 6. The platoon leader repositions the base-of-fire element as necessary to continue to isolate and suppress the remaining bunkers and to maintain suppressive fires.
 7. The platoon leader either designates one of the remaining squads not in contact to move up and knock out the next bunker; or, he directs the assaulting squad to continue and knock out the next bunker. The platoon leader considers the condition of his assaulting squad and the situation, and rotates squads as necessary.
 8. The assaulting squad takes action to knock out the next bunker (see paragraph 5).
 9. The platoon leader reports, reorganizes as necessary, and continues the mission. The company follows up the success of the platoon attack and continues to assault enemy positions.

Battle Drill 7 CONDUCT INITIAL BREACH OF A MINED WIRE OBSTACLE (PLATOON)

SITUATION: The platoon is operating as part of a larger force (mounted or dismounted). The lead section or squad identifies a wire obstacle, reinforced with mines that cannot be bypassed. The enemy begins to engage the platoon from positions on the far side of the obstacle.

REQUIRED ACTIONS (Figure E-16 and Figure E-17, page E-32):

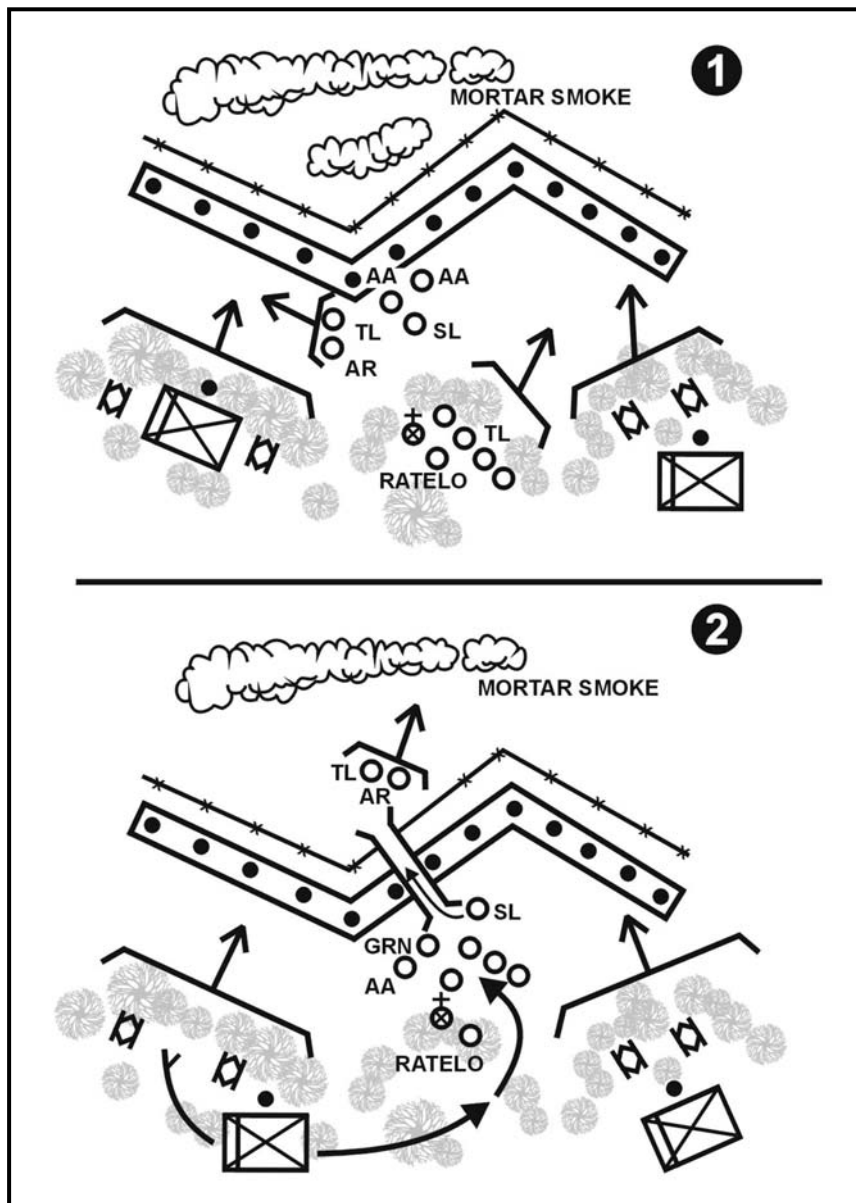

Figure E-16. Conduct initial breach of a mined wire obstacle (platoon).

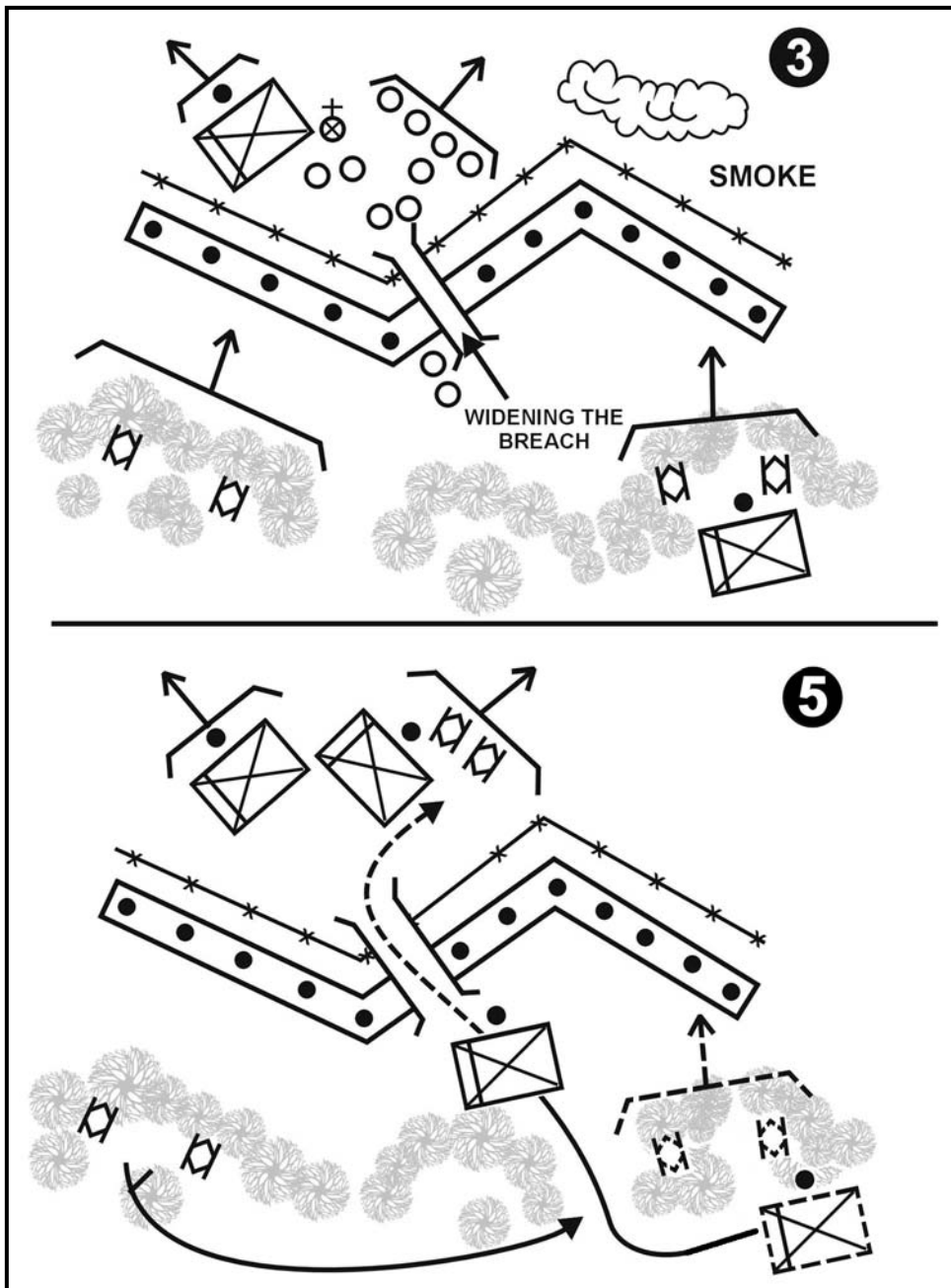

Figure E-17. Conduct initial breach of a mined wire obstacle (platoon) (continued).

1. The section/squad in contact reacts to contact.
2. The platoon places suppressive fires on the enemy. The section/squad in contact establishes a base-of-fire position. The platoon leader, his RATELO, and the squad leaders of the squads not in contact move forward to link up with the squad leader of the squad in contact.

3. The platoon sergeant repositions the BFVs, if necessary, to provide additional observation and supporting fires.
4. The platoon leader determines that he can maneuver by identifying—
 - The location, size, composition, and orientation of the obstacle
 - The enemy positions covering it by fire.
 - The size of the enemy force engaging the section or squad. (The number of enemy automatic weapons, the presence of any vehicles, and the employment of indirect fires are indicators of enemy strength.)
 - A breach point.
 - A covered and concealed route to the breach point.
5. The platoon leader designates the base-of-fire squad, the breach squad and the assault squad. He directs the BFVs and the base-of-fire squad to support the movement of the other squads to the breach point and assault position. He indicates the enemy positions to be suppressed, and the route that the rest of the platoon will take to the breach point. He also gives instructions for lifting and shifting fires.
6. On the platoon leader's signal, the base-of-fire element—
 - Destroys or suppresses enemy crew-served weapons.
 - Obscures the enemy position with smoke (M203).
 - Sustains suppressive fires at the lowest level possible.
7. The platoon leader then directs the squad leader to the designated breach point. The squad leader leads the breach squad along the covered and concealed route to the breach point.
8. The platoon leader/sergeant calls for and adjusts indirect fires.
9. The breach squad executes actions to breach the obstacle (footpath).
 - a. The squad leader directs one fire team to support the movement of the other fire team to the breach point.
 - b. The squad leader identifies the breach point.
 - c. The base-of-fire element continues to provide suppressive fires and isolates the breach point.
 - d. The breaching fire team, with the squad leader, moves to the breach point using the covered and concealed route.
 - (1) The squad leader and breaching fire team leader employ smoke grenades to obscure the breach point. The platoon base-of-fire element shifts direct fires away from the breach point and continues to suppress key enemy positions that can affect the breach site. The platoon leader/sergeant shifts indirect fires beyond the obstacle, keeping obscuration between the obstacle and the enemy force.
 - (2) The breaching fire team leader positions himself and the automatic rifleman on one flank of the breach point to provide close-in security.
 - (3) Under the direction of the squad leader, the rifleman/antiarmor specialist and automatic rifleman of the breaching fire team probe for mines, and cut the wire obstacle, marking their path as they proceed.
 - (4) Once the obstacle has been breached, the breaching fire team leader and the automatic rifleman move to the far side of the obstacle and take up covered and concealed positions. They signal to the squad leader when they are in position and ready to support.

e. The squad leader signals the base-of-fire team leader to move his fire team up and through the breach. He then moves through the obstacle and joins the breaching fire team leader and the automatic rifleman, leaving the rifleman/antiarmor specialist and automatic rifleman on the near side of the breach to guide the rest of the squad (and platoon) through.

f. Using the same covered and concealed route as the breaching fire team, the base-of-fire team moves through the breach and takes up covered and concealed positions on the far side.

10. The breach squad leader reports the situation to the platoon leader and places guides at the breach point.

11. The platoon leader then leads the assault squad along the covered and concealed route through the breach in the obstacle and positions it on the far side to support the movement of the remainder of the platoon or assaults the enemy position covering the obstacle.

12. The breaching squad reduces the obstacle to allow the BFVs to pass through.

13. The platoon leader reports the situation to the company commander and directs his breaching and base-of-fire squads to move through the obstacle. The platoon leader leaves the guides to lead the company through the breach point.

14. The platoon sergeant brings the BFVs forward, through the breach on the platoon leader's command.

15. The platoon leader reports, reorganizes as necessary, and continues the mission.

Section II. CREW DRILLS

A crew drill is a collective action that the crew of a weapon or piece of equipment must perform to successfully use the weapon or equipment in combat or to preserve life. This action is a trained response to a given stimulus such as a simple leader's order or the status of the weapon or equipment. It requires minimal leader orders to accomplish and is standard throughout the Army.

Crew Drill 1
BAIL OUT (CREW/FIRE TEAM)

SITUATION: The BFV, with a fire team mounted, has received hostile fire requiring the crew and fire team to evacuate the vehicle.

REQUIRED ACTIONS:

1. Bailout procedures for the BFV crew.

a. **Bradley Commander:**

(1) Alerts soldiers by the intercommunications system or by voice command if the intercom system does not work. Commands BAIL OUT.

NOTE: As soldiers bail out they should use the BFV for cover from enemy direct fires.

(2) Turns the turret power switch to OFF.

(3) Evacuates the vehicle through the BC's hatch.

b. **Gunner:** Evacuates the vehicle through the hatch.

c. **Driver:**

(1) Stops the vehicle.

(2) Shuts down the vehicle by pulling out the fuel control handle.

(3) Lowers the ramp.

(4) Disconnects the CVC helmet and unfastens the seat belt.

(5) Secures his weapon.

(6) Turns the master-power switch to OFF.

(7) Evacuates the vehicle through the driver's hatch, if possible. If the driver cannot evacuate through the driver's hatch, he exits through the ramp door.

2. Bailout procedures for the troop compartment and fire team members.

a. **Squad Leader or Fire Team Leader:**

(1) Announces BAIL OUT.

(2) Pulls the quick disconnect to release the CVC helmet or headsets.

(3) Disconnects the seat belt.

(4) Secures his weapon.

(5) Evacuates the vehicle through the ramp or ramp door.

b. **Fire Team Members:**

(1) Disconnect the seat belts.

(2) Pulls the quick disconnect to release the CVC helmet or headsets (M2A3 only).

(3) Secure their weapons.

(4) Evacuate the vehicle through the ramp door or the cargo hatch. The fire team member in the No. 4 seat attempts to evacuate through the driver's hatch.

3. Senior man accounts for soldiers and equipment.

Crew Drill 2

EVACUATE INJURED PERSONNEL FROM A BFV

SITUATION: A crewmember or fire team member has been injured.

REQUIRED ACTIONS:

Evacuate BC or Gunner - Hatch

Evacuate the gunner through the hatch. (If BC is the casualty, the gunner will perform the same actions.)

1. **Bradley Commander:** Commands EVACUATE THE GUNNER.
2. **Driver:** Moves to the nearest covered position and halts the vehicle.
3. **Bradley Commander:**
 - a. Attempts to rotate the turret to the 6400-mil position.
 - b. Engages the turret travel lock.
 - c. Sets the turret drive system switch to OFF.
4. **Fire Team Members in the No. 7 and No. 9 Positions:** Exit the vehicle through the ramp access door, the ramp, or if necessary the cargo hatch, and move to the outside of the turret to assist in removing the injured gunner or BC.
5. **Bradley Commander:** Places the gunner in position for removal from the vehicle. Adjusts the seat to the raised position, being careful not to cause further injury. Unfastens the seat belt.
6. **Fire Team Members:**
 - a. Place a pistol belt (or similar device) around the gunner's chest and slowly pull the gunner out. Move the gunner to the front edge of the vehicle. If the gunner and BC are wearing CVC suits, grasp the straps on the back of the suit and pull the gunner or BC out of the vehicle.
 - b. Lower the gunner or BC from the vehicle to the two fire team members on the ground.
 - c. Place the gunner or BC on the ground and administer first aid.

Evacuate BC or Gunner – Turret Shield Door

If the gunner cannot be evacuated through the hatches, evacuate through the turret shield door. (If BC is the casualty, the gunner will perform the same actions.)

7. **Gunner:** Commands EVACUATE THE BC.
8. **Driver:** Moves to the nearest covered position and halts the vehicle.
9. **Gunner:**
 - a. Rotates the turret to the 6400-mil position.
 - b. Engages the turret travel lock.
 - c. Sets the turret drive system switch to OFF.
 - d. Places the BC in position for removal from the vehicle, without causing further injury.
10. **Fire Team Member in the No. 5 position:**
 - a. Opens the turret shield door, grasps the BC under the armpits, and pulls him out of the turret.
 - b. Carries the BC to a flat surface and administers first aid.

Evacuate Driver

11. **Bradley Commander:** Commands EVACUATE THE DRIVER.

NOTE: If the driver is unable to halt the vehicle, a fire team member must move forward, behind the driver's seat, and pull the fuel shutoff handle to stop the engine.

12. **Gunner:**

- a. Ensures the turret exposes the driver's hatch.
- b. Engages the turret travel lock.
- c. Sets the turret drive system switch to the OFF position.

13. **Bradley Commander:**

- a. Exits the vehicle.
- b. Releases the trim vane (M2A1 only).

NOTE: The M2A2/A2-ODS/A3 BFV does not have a trim vane attached to the vehicle's front slope. The BC must determine the urgency to evacuate the driver and treat the driver's wounds before deciding to install the work platform.

14. **Fire Team Members:**

- a. Move forward behind the driver and lowers the backrest of the driver's seat, using the backrest release handle on the right side just beneath the backrest, lowers the driver's seat backrest.
- b. Assist the BC in removing the driver from the vehicle.

15. **Bradley Commander:**

- a. Opens the driver's hatch.
 - (1) If the driver's hatch is damaged and will not open, the fire team member pulls the driver back into the troop compartment.
 - (2) The BC's duties can be performed by the gunner.
- b. Disconnects the CVC helmet and the safety belt.
- c. Crosses the driver's arms over his chest. (If this is not possible, wraps a belt around the driver's chest to raise him.)
- d. Pulls the driver out of the vehicle and hands him to the fire team members on the ground.

16. **Fire Team Members:**

- a. Assist the BC in pulling the driver from the vehicle.
- b. Two fire team members dismount to the left front of the vehicle to assist by taking the driver from the BC. They lay him on the ground and administer first aid.
- c. One fire team member remains in the vehicle and assists in the removal of the driver by untying his legs as necessary.

Evacuate Fire Team Member

17. **Squad/Fire Team Leader:** Informs the BC that a fire team member is injured.
18. **Bradley Commander:** Commands EVACUATE FIRE TEAM MEMBER.
19. **Driver:** Moves to the nearest covered position, halts the vehicle, and lowers the ramp.

NOTE: Depending on which fire team member is injured, the fire team leader designates which member will assist in evacuating the casualty. If the squad leader or fire team leader is injured, then the next senior man takes charge.

20. **Squad/Fire Team Members:** Two fire team members remove the injured member, lay him on the ground, and perform first aid, as needed.

Crew Drill 3 EXTINGUISH A FIRE (CREW)

SITUATION: Upon automatic or manual discharge of the fire suppression system. The BFV crew and fire team are mounted. The BC alerts personnel of a fire.

REQUIRED ACTIONS:

1. Extinguish a fire in the engine compartment.

a. **Bradley Commander:**

(1) Alerts the soldiers of an engine compartment fire by the intercommunications system or by voice command if the intercommunications system does not work. Commands FIRE, ENGINE COMPARTMENT. Rotates the turret to 6400 mils to ensure the cargo hatch can fully open. If the ramp or ramp access door fails to open, the cargo hatch is the only route of escaped for those in the troop compartment.

(2) Turns the turret power switch to OFF.

b. **Driver:**

(1) Stops the vehicle.

(2) Shuts down the engine by pulling out the fuel control handle.

(3) Discharges the Halon bottle by rotating the release valve inside the driver's compartment if it has not been automatically discharged.

(4) Lowers the ramp (TM 9-2350-252-10-1 or TM 9-2350-284-10-1).

(5) Turns the master power switch to OFF.

(6) Disconnects the CVC helmet and unfastens the seat belt.

(7) Secures his weapon.

(8) Evacuates the vehicle through the driver's hatch, if possible. If the driver is unable to evacuate through the driver's hatch, he exits through the ramp.

c. **Fire Team Members:**

(1) Disconnect the seat belts.

(2) Squad leader or fire team leader pulls the quick disconnect to release the CVC helmets or headsets. Fire team members, also (M2A3 only)

(3) Secure their weapons.

(4) The fire team members in the No. 4, 5 and 8 positions secure the rear portable fire extinguishers.

(5) Evacuates the vehicle through the ramp.

d. **Bradley Commander:** Evacuates the vehicle through the BC's hatch.

e. **Gunner:** Evacuates the vehicle through the gunner's hatch.

NOTE: If the fire is not extinguished, use the portable fire extinguishers.

2. Extinguish a fire in the troop compartment.

a. **Squad Leader or Fire Team Leader:** Alerts the BC of a troop compartment fire by intercommunications system or by voice command if the intercommunications system does not work. Announces FIRE, TROOP COMPARTMENT.

b. **Bradley Commander:** Turns the turret power to OFF, and evacuates the vehicle through the BC's hatch.

- c. **Gunner:** Evacuates the vehicle through the gunner's hatch.
- d. **Driver:**
 - (1) Stops the engine.
 - (2) Shuts down the vehicle and pulls out the fuel control handle.
 - (3) Lowers the ramp.
 - (4) Turns the master power switch to OFF.
 - (5) Pulls the quick disconnect to release the CVC helmet and seat belt.
 - (6) Unfastens his seat belt.
 - (7) Secures his weapon.
 - (8) Evacuates the vehicle through the driver's hatch.
- e. **Fire Team Members:**
 - (1) Unfasten the seat belts.
 - (2) The squad or fire team leader pulls the quick disconnect to release the CVC helmets and headsets. Fire team members, also (M2A3 only)
 - (3) Secures their weapons.
 - (4) The fire team members in the No. 4, 5 and 8 seats secure the portable fire extinguishers.
 - (5) Evacuate the vehicle through the ramp.
 - (6) The fire team member in the No. 9 seat pulls the handle to activate the troop-area fire extinguishers from the outside.

NOTE: If the fire is not extinguished, use the portable fire extinguishers.

Crew Drill 4 DISMOUNT THE VEHICLE (PLATOON/SQUAD)

SITUATION: The platoon/squad is mounted and must dismount. The platoon leader orders the platoon/section to prepare to dismount.

REQUIRED ACTIONS (Figure E-18):

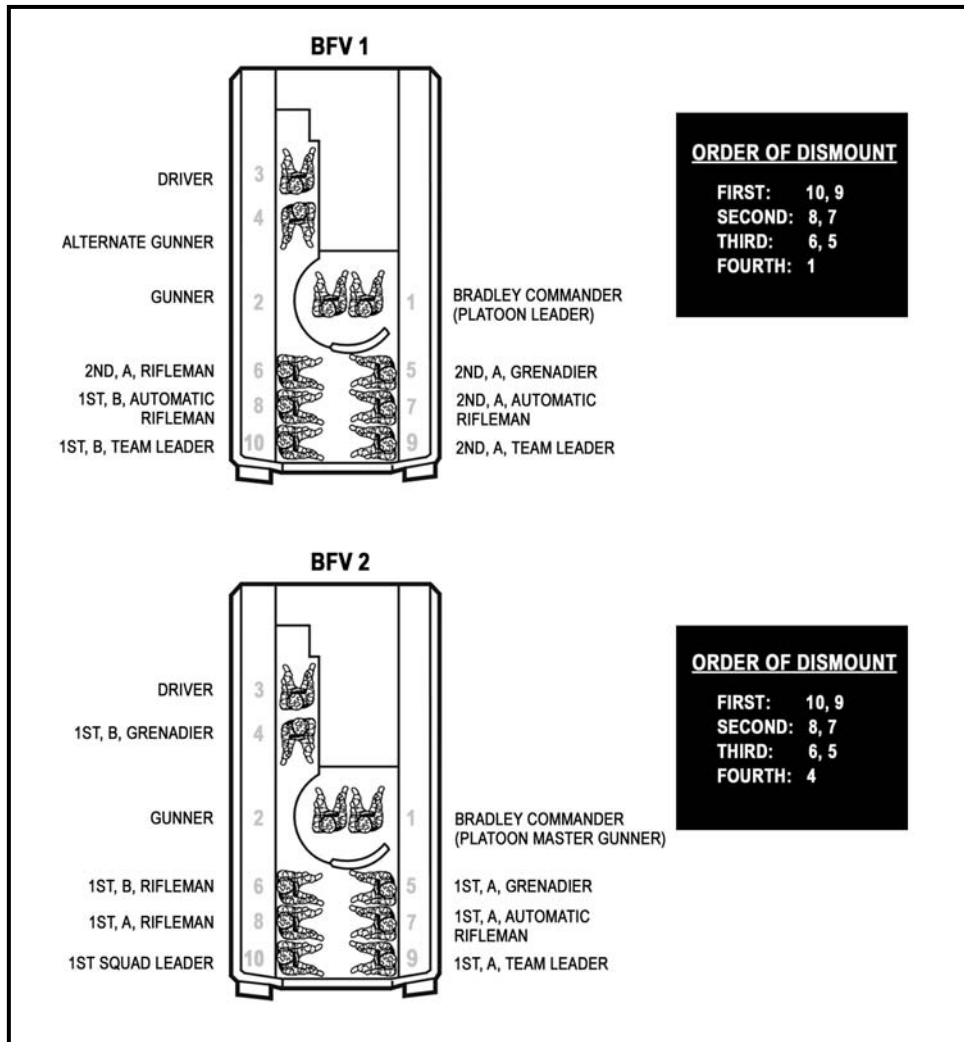

Figure E-18. BFV order of dismount.

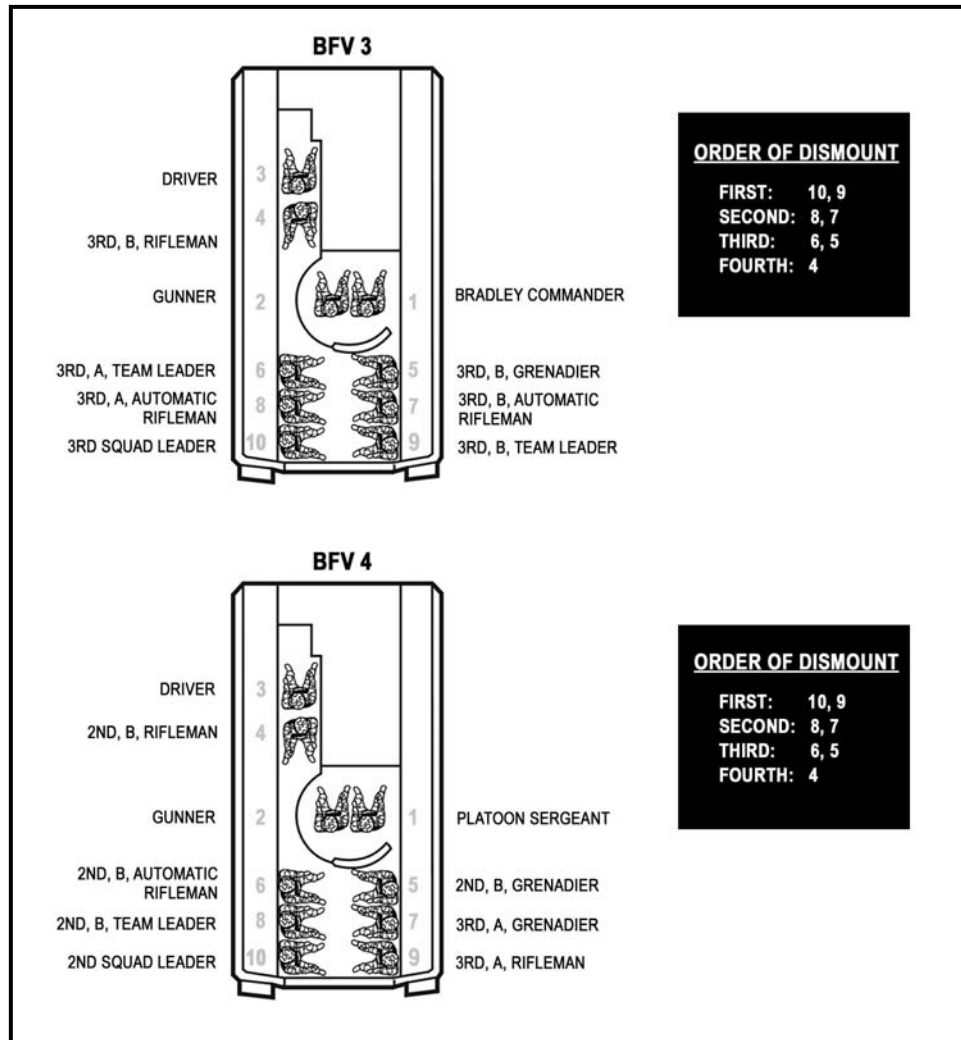

Figure E-18. BFV order of dismount (continued).

1. The platoon leader selects the dismount point.
2. The platoon leader orders personnel to dismount.
 - a. Gives the warning PREPARE TO DISMOUNT.
 - b. Designates dismounted platoon's weapons composition; for example, "No Javelins", "Heavy on AT4s", or "All M240B".
 - c. Gives dismount instructions for each BFV; for example, "Right" (left), distance "Fifty meters," and any identifying terrain feature "Backside of hill." The BC may also give dismount instructions to the fire team aboard. The BC can identify the location to the squad/team leader through the squad leader's display (SLD). (M2A3 only)
3. Squad/fire team leader(s) monitors commands. He then alerts the soldiers in the troop compartment.
4. The drivers move the vehicles to the designated dismount point and orient the front of the vehicle toward the enemy.
5. The gunners orient the turret to provide overwatching support and supporting fire, if necessary.

6. The platoon leader gives the command DISMOUNT.
7. Fire team members take the M231 firing port weapons out of the ramp and secure them in the vehicle, if employed.
8. The drivers stop the vehicle and lowers the ramp or the BC orders the ramp access door opened.
9. The fire team members dismount in the specified order and then move to covered and concealed positions. The fire team then links up with the squads and continues with the rest of the mission. The squad leader establishes contact with the platoon leader.
10. The mounted element occupies covered positions and overwatches the dismounted element with the appropriate weapon.
11. Platoon/squad leader reports to higher headquarters.
12. All squad members search for enemy positions and respond to orders.
13. Squad and fire team leaders position or reposition squad members (if needed).
14. The platoon sergeant or section leader repositions the BFVs, as necessary.

Crew Drill 5 MOUNT THE VEHICLE (PLATOON/SECTION)

SITUATION: The squads are dismounted and must remount the vehicle. The platoon/squad leader orders the platoon to mount their vehicles.

REQUIRED ACTIONS (Figure E-19):

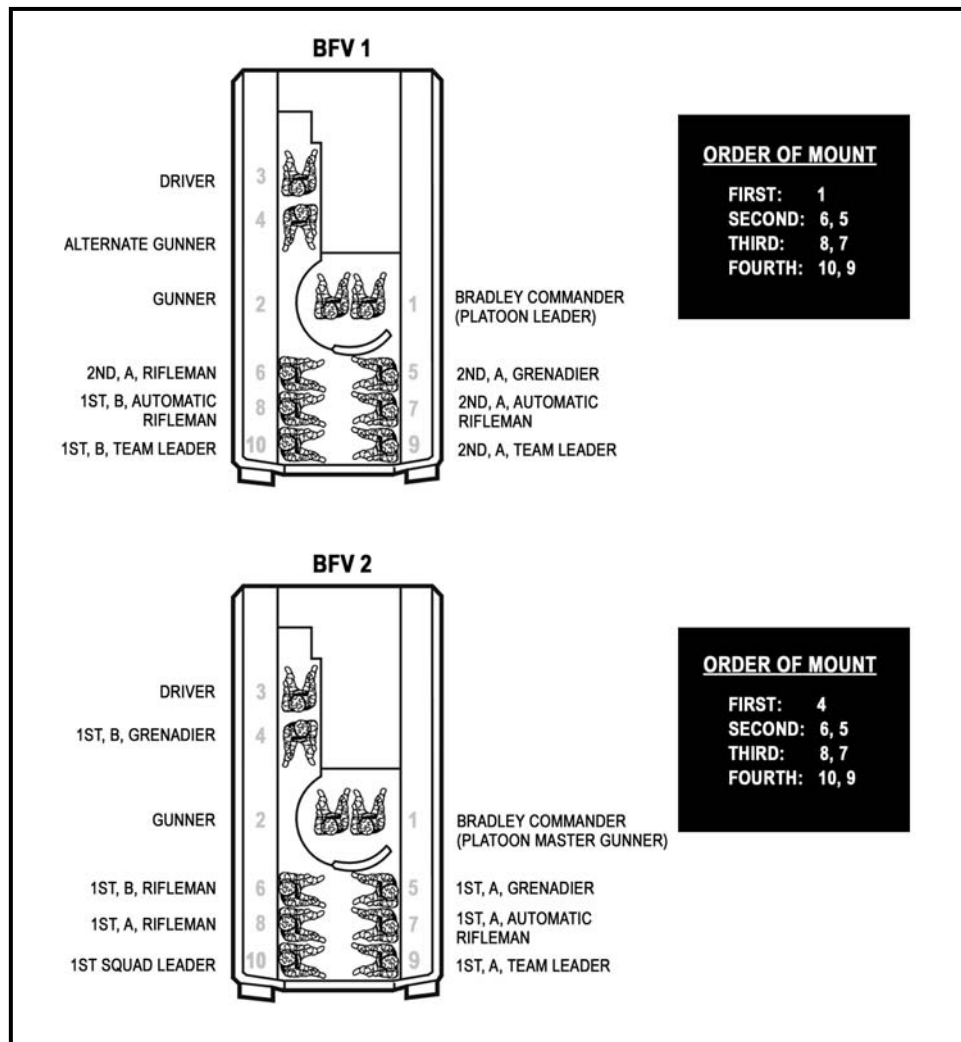

Figure E-19. BFV order of mount.

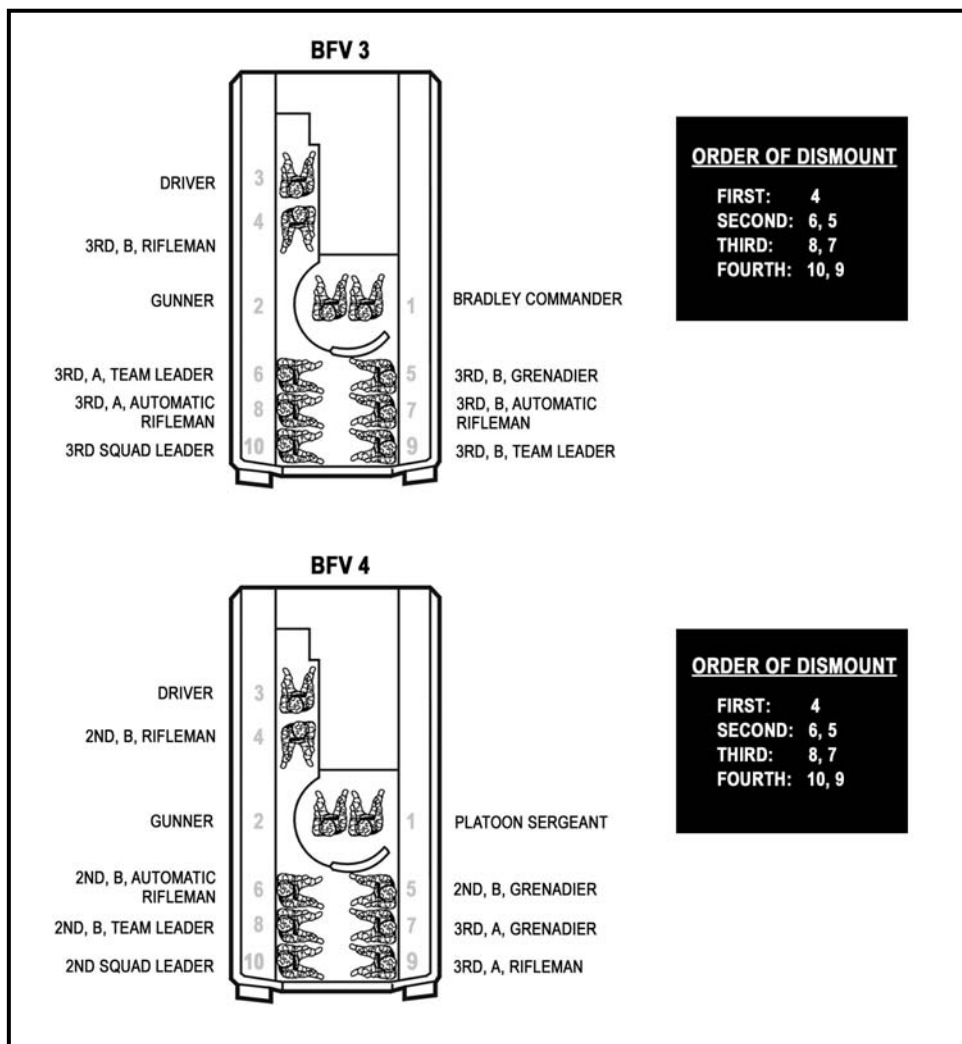

Figure E-19. BFV order of mount (continued).

1. The platoon/squad leader(s) gives the order PREPARE TO MOUNT or the appropriate signal to the squads to mount their BFVs, and designates a mount/remount point.
2. Both elements (mounted and dismounted) move to the mount/remount point using covered and concealed routes.
3. The crew, using the appropriate weapons, overwatches primary enemy avenues of approach and provides supporting fire and smoke, if necessary. The BC orders the driver to lower the ramp, or the fire team to enter through the ramp access door.
4. The platoon/squad leader orders MOUNT. (The order to mount may come with clarifying instructions; for example, “1st Squad and 3d Squad, provide a base of fire until 2d Squad is mounted.”)
5. Each squad/team mounts in the order specified. The squad leader designates which fire team mounts first; for example, Team A mount first, Team B provide overwatching fires.
6. Soldiers mount/remount the vehicle in reverse sequence of dismount.

7. The platoon leader/BC prepares for mounted operations.
 - a. Each fire team leader accounts for all personnel and equipment in the BFV, and reports to the BC. Announces, ALL UP.
 - b. The platoon leader designates a direction of movement, formation, and movement technique from the mount point.
 - c. The platoon leader establishes visual or radio contact with the other BCs.
 - d. The team leader ensures the dismounted weapons are on SAFE once the soldiers have mounted.
 - e. The BC orders the driver to raise the ramp or the fire team to close the ramp access door. The fire team members in the No. 9 and 10 seats install their firing port weapons, if directed.
8. The platoon leader reports to the company commander.

**CREW DRILL 6
CHANGE FORMATION (MOUNTED) (PLATOON)**

SITUATION: The platoon is moving and must change formation. The platoon leader gives arm-and-hand signal, flag signal, or radio for change of formation.

REQUIRED ACTIONS (Figures E-20 through E-35, page E-48 through E-63):

1. The platoon leader directs the formation change by giving the standard arm-and-hand signals, flag signals, or by radio.
2. The BCs relay arm-and-hand or flag signals.
3. The BCs direct drivers into position in the new formation. The driver maintains the position in the formation based on the platoon leader and wingmen.
4. The BCs traverse the main weapons toward likely enemy positions or assigned sectors and instruct the gunners to scan for targets in their sectors. The BCs give the gunners the limits of their sectors using the turret position indicator (for example, scan from 12 to 2).

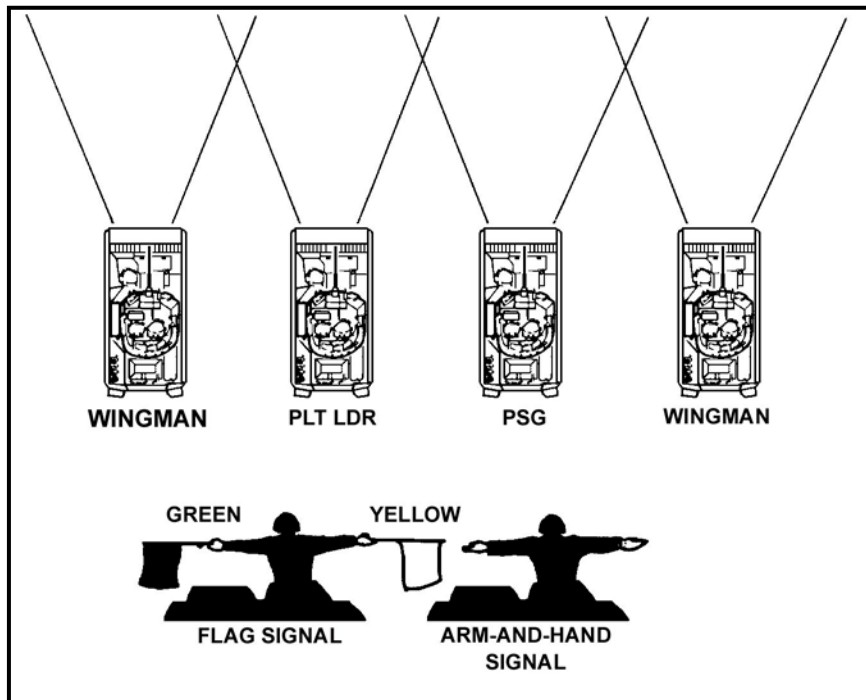

Figure E-20. Line formation.

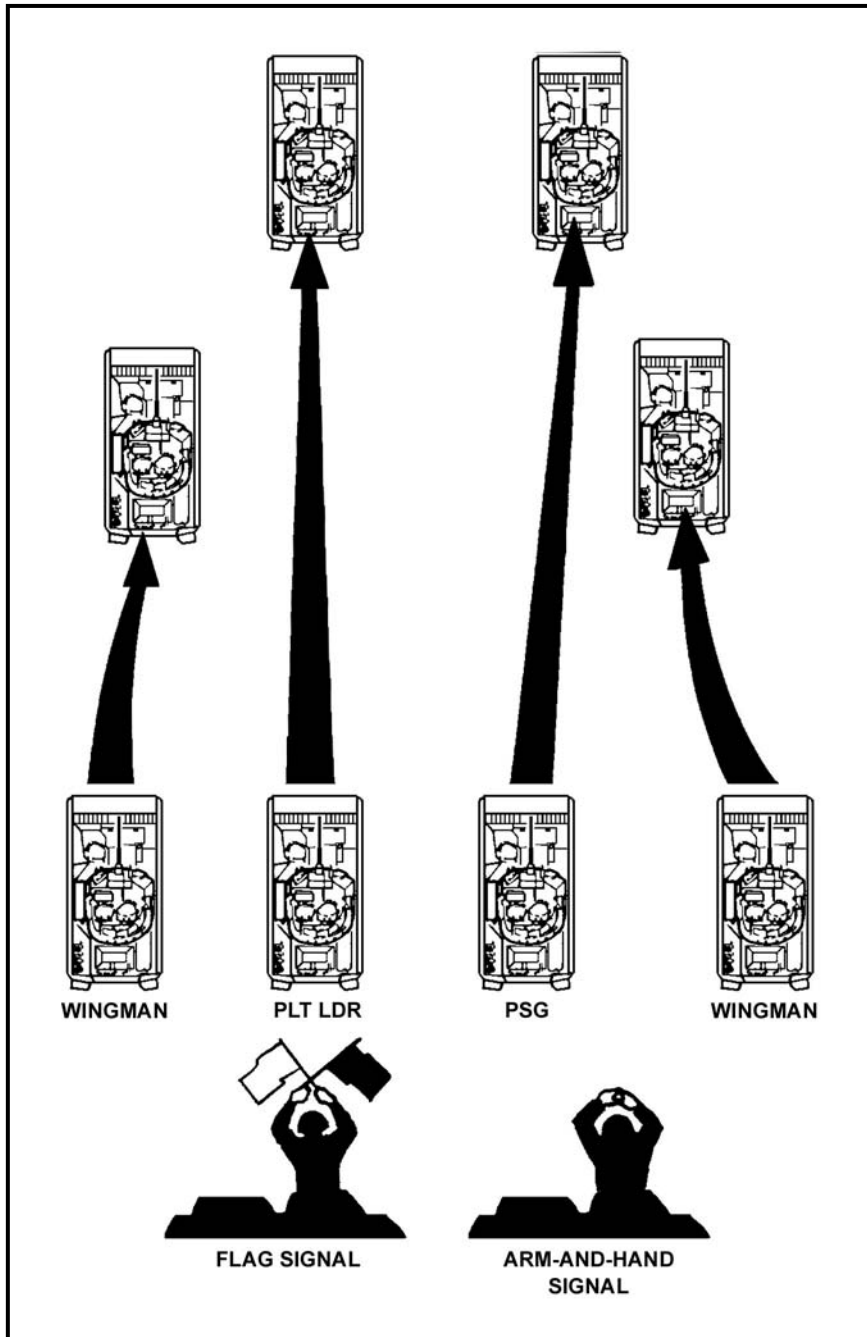

Figure E-21. Line to wedge formation.

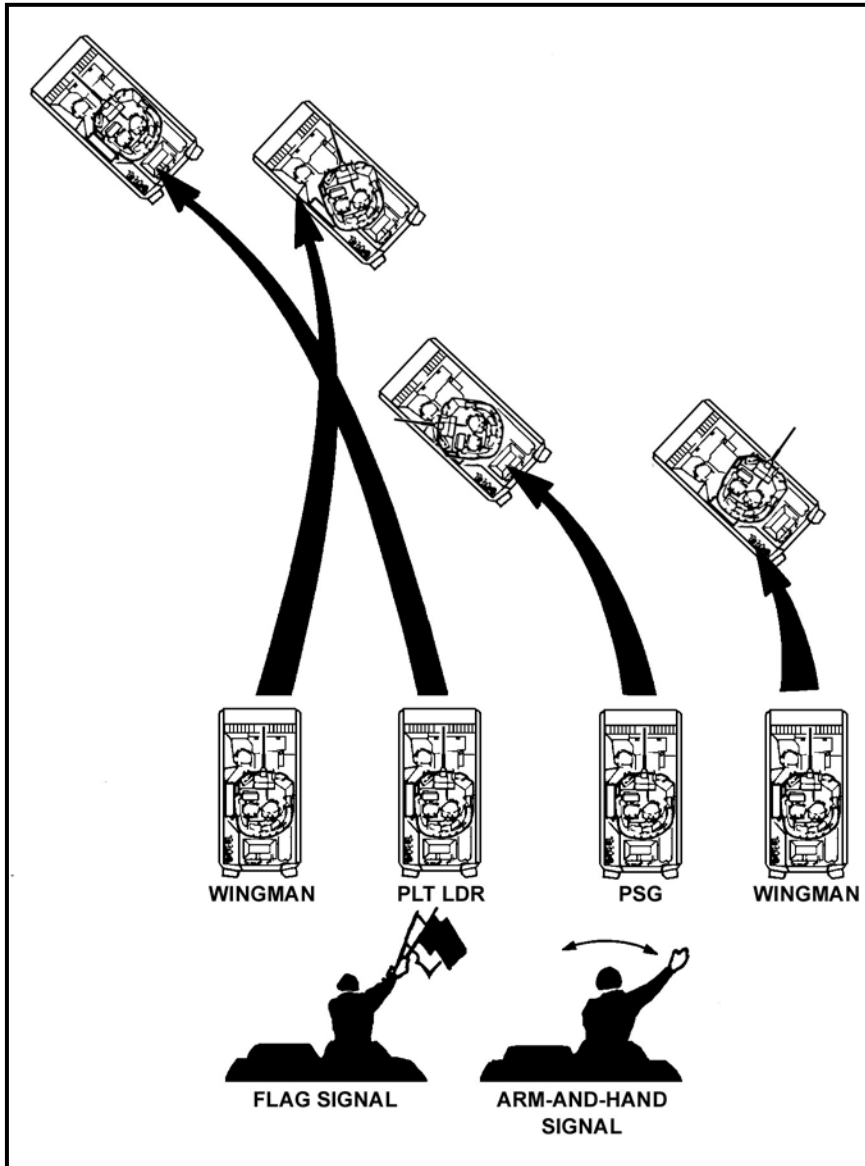

Figure E-22. Line to column formation.

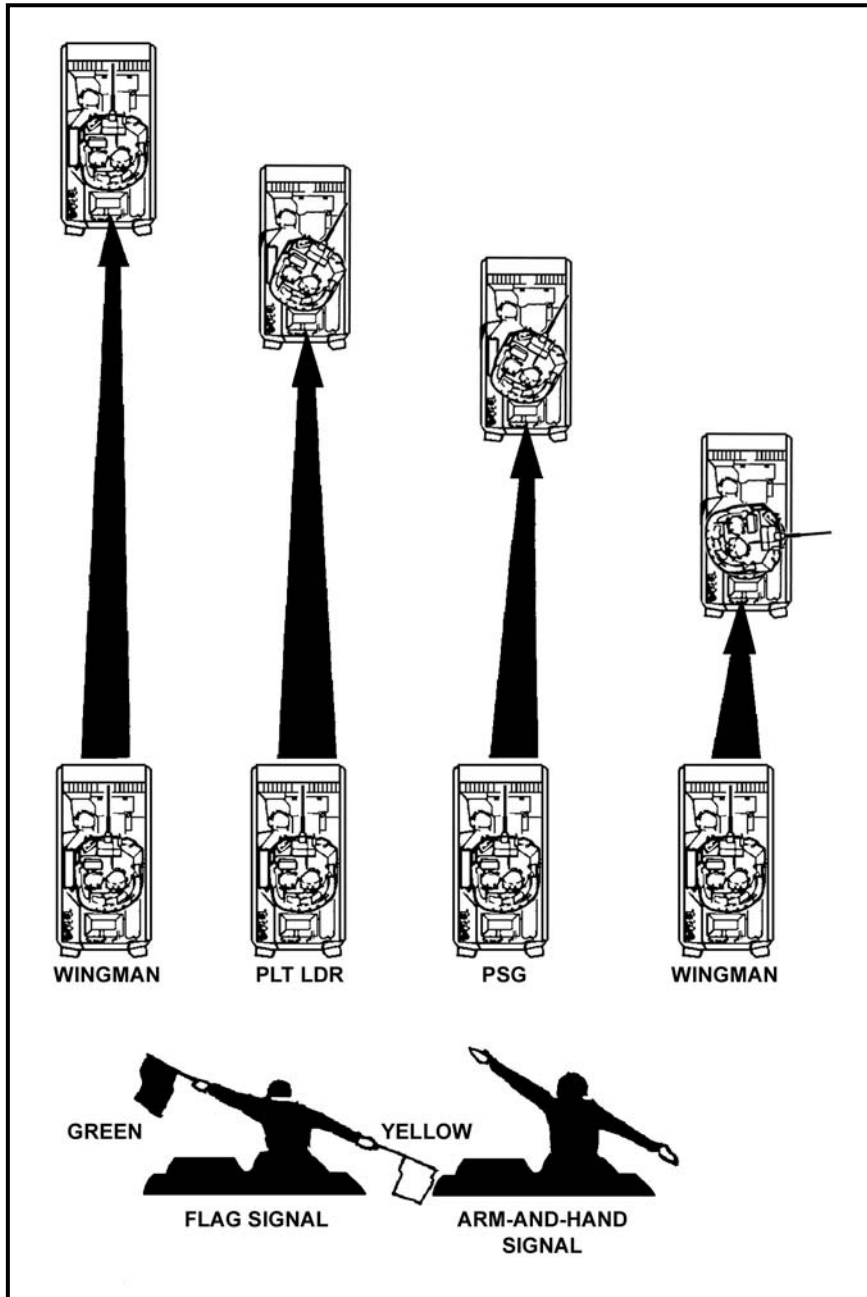

Figure E-23. Line to echelon formation.

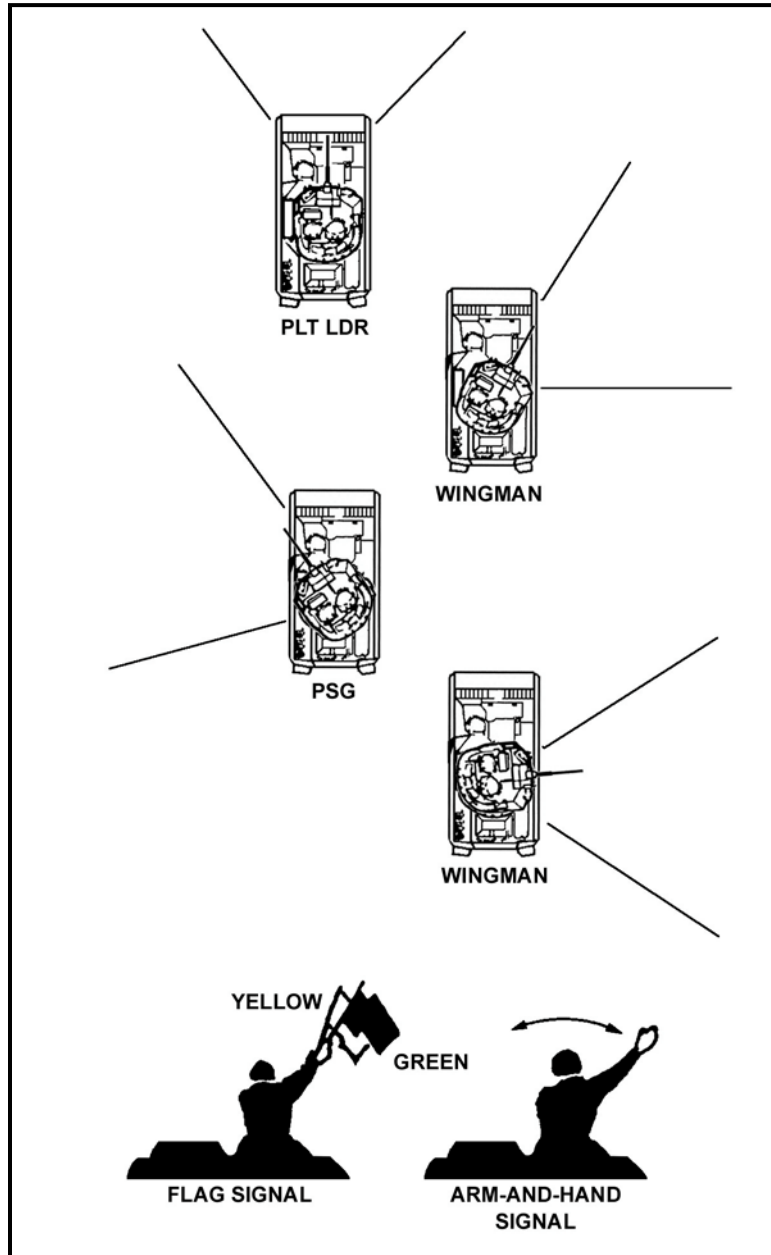

Figure E-24. Column formation.

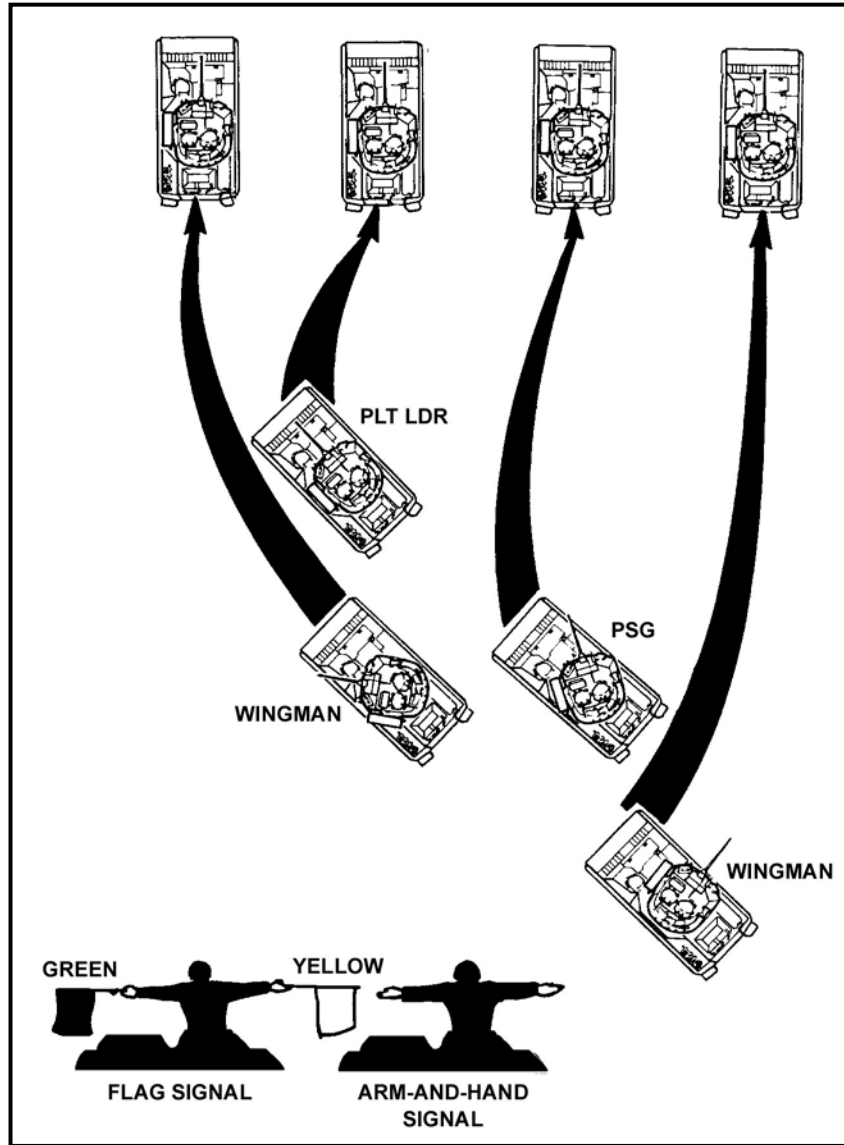

Figure E-25. Column to line formation.

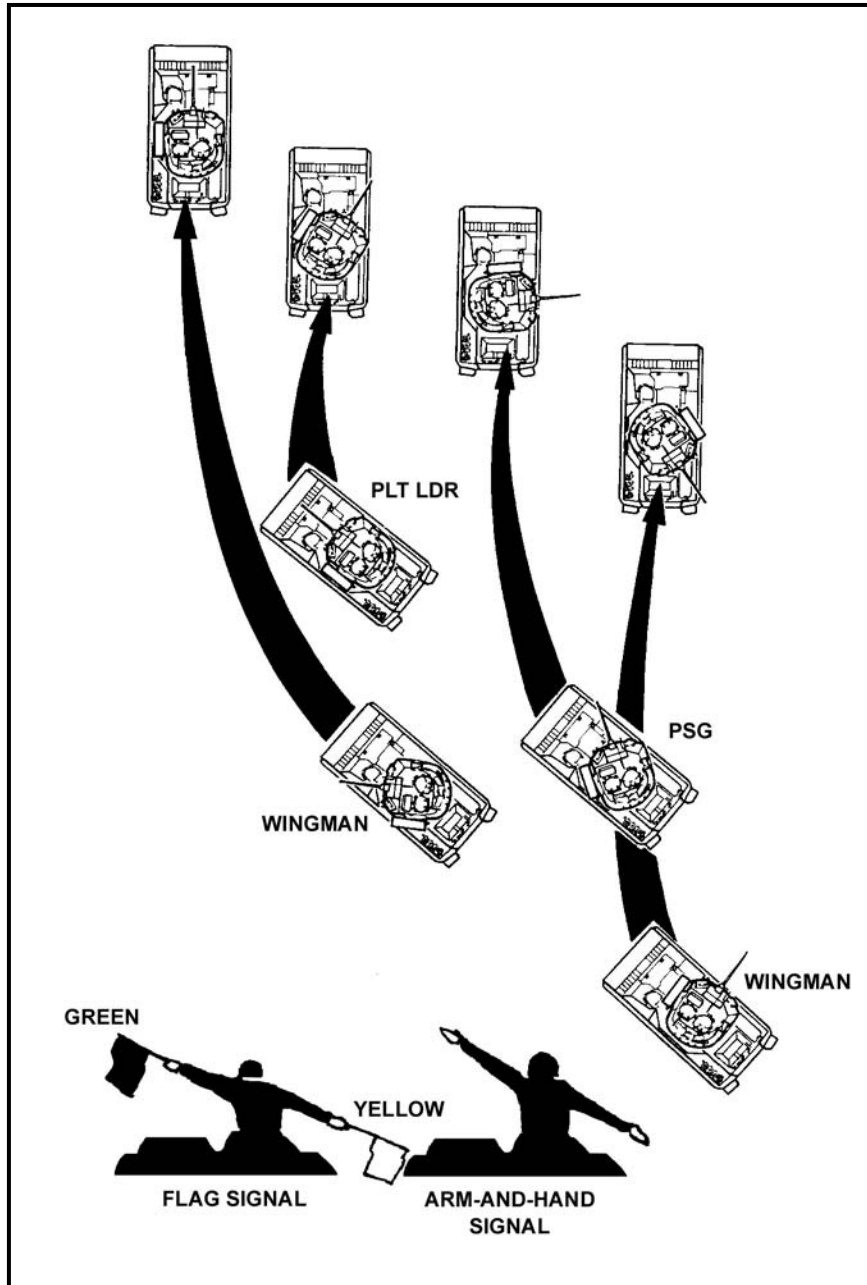

Figure E-26. Column to echelon formation.

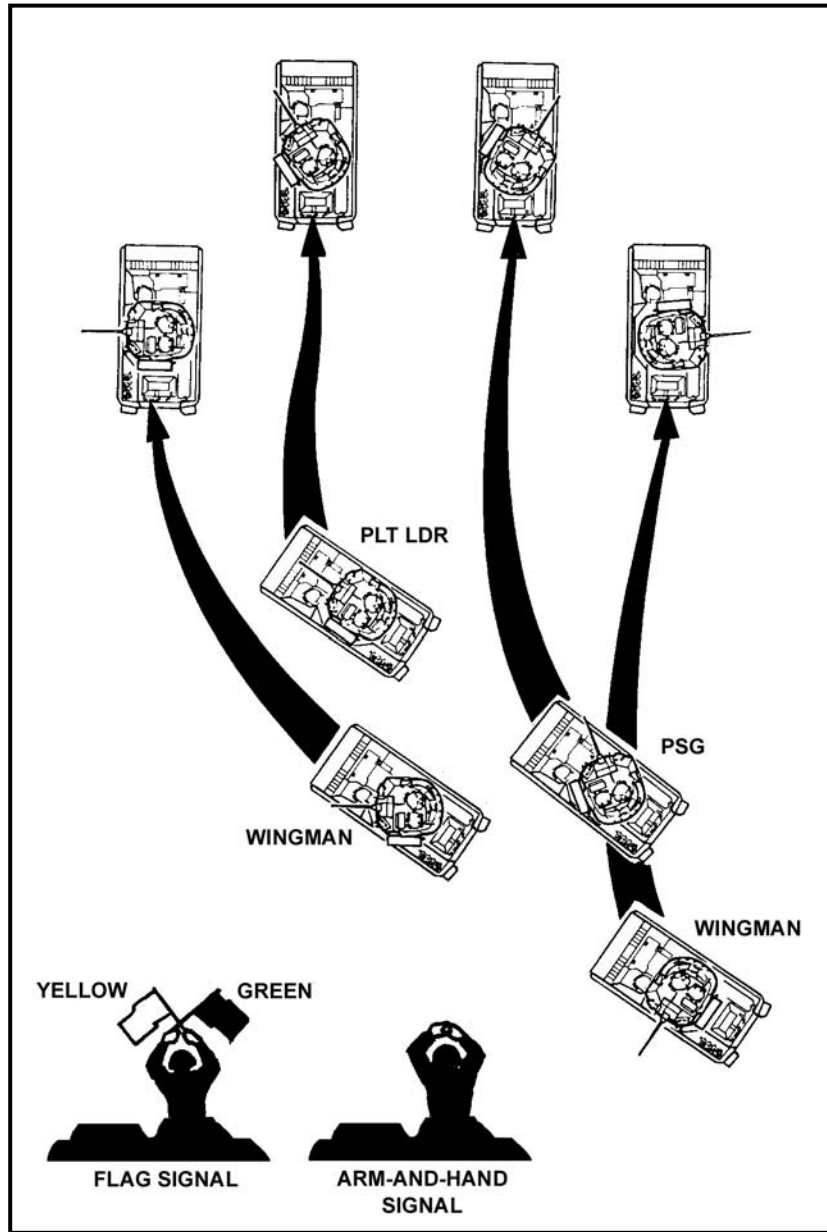

Figure E-27. Column to wedge formation.

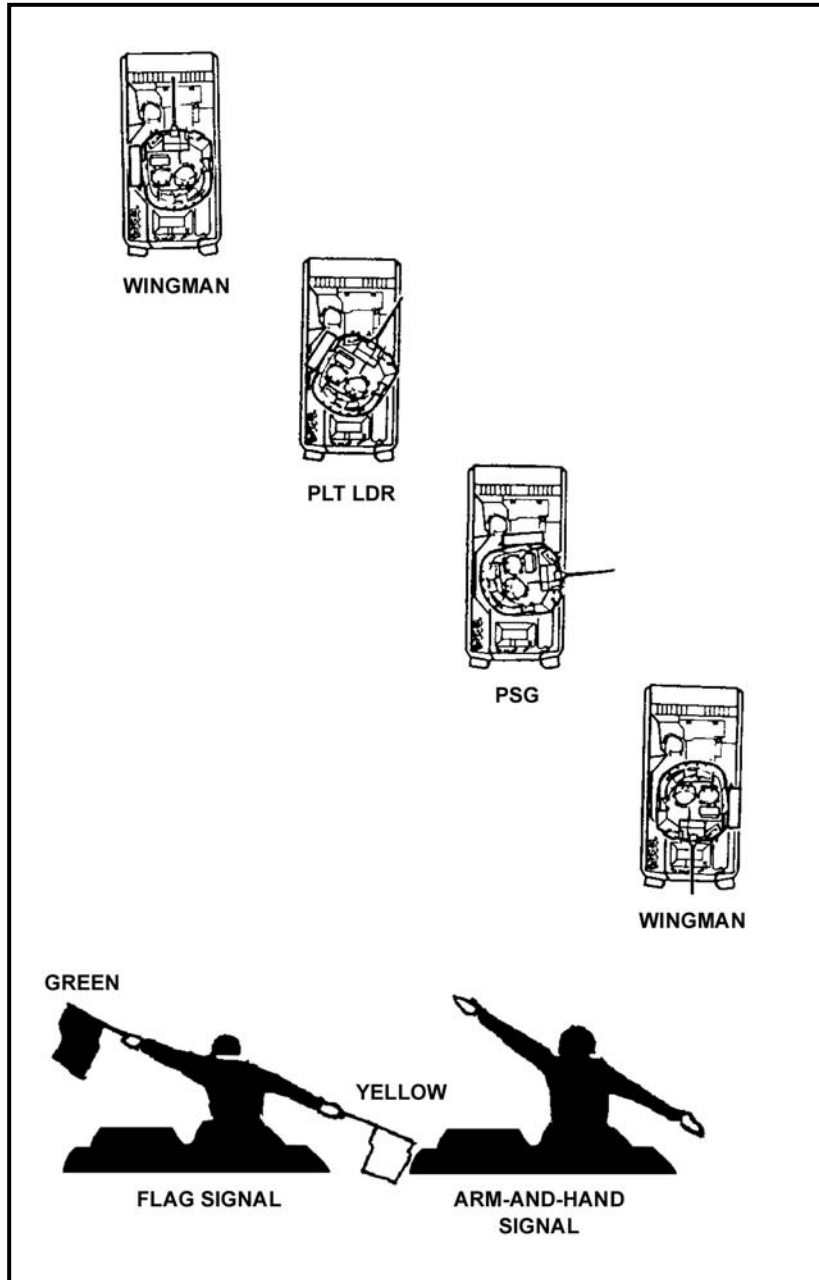

Figure E-28. Echelon formation (right).

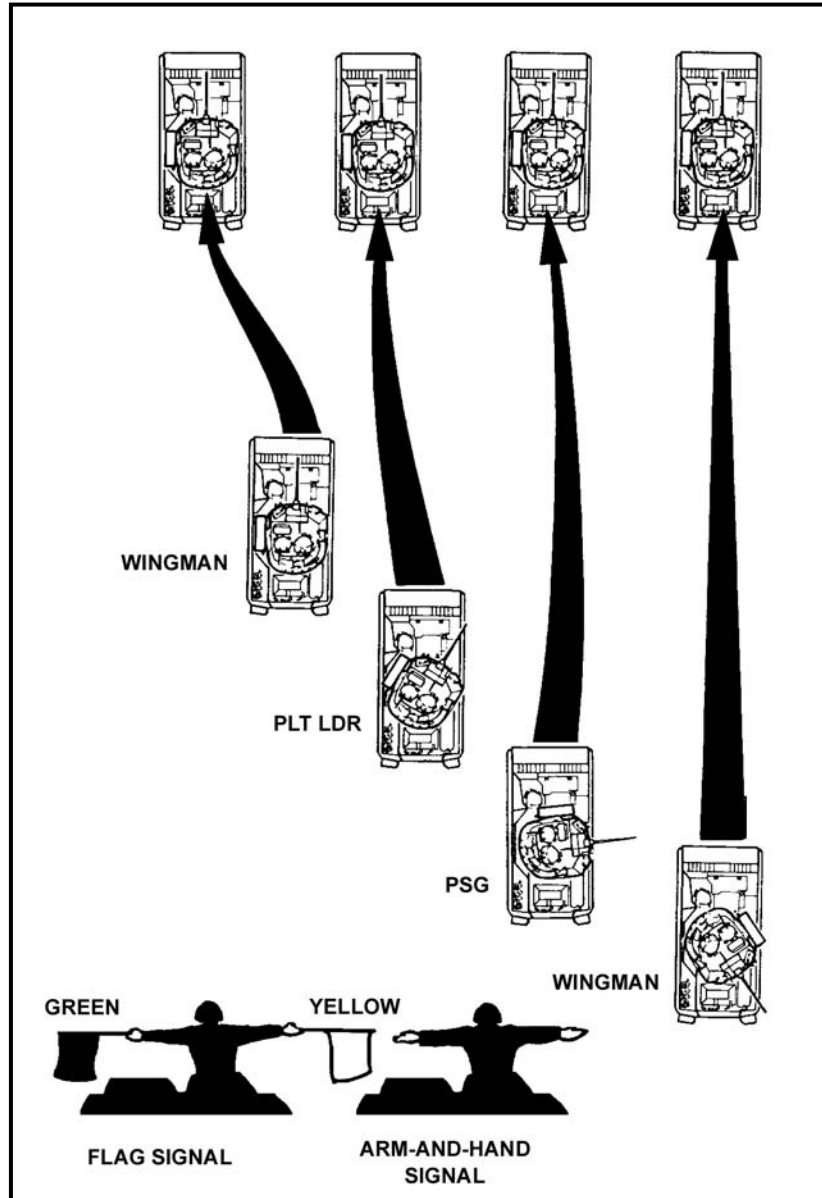

Figure E-29. Echelon to line formation.

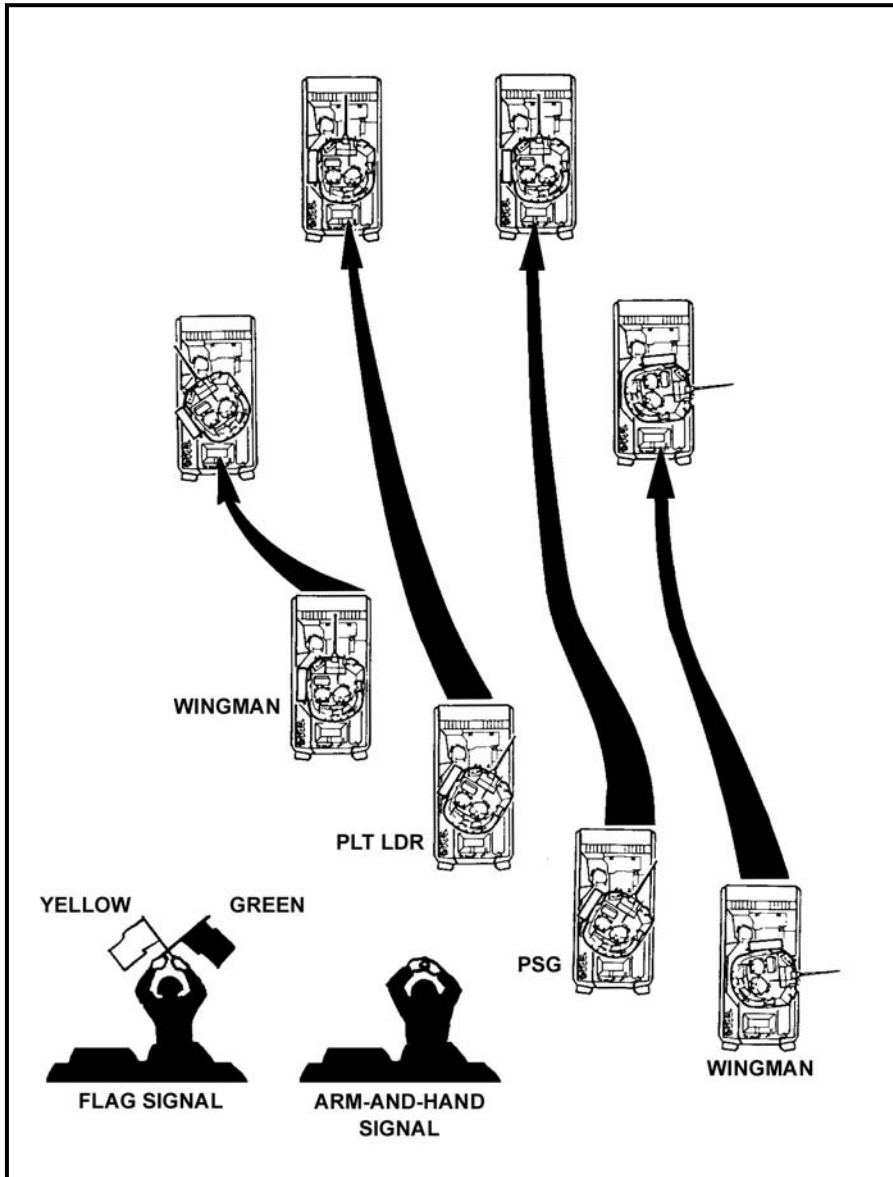

Figure E-30. Echelon to wedge formation.

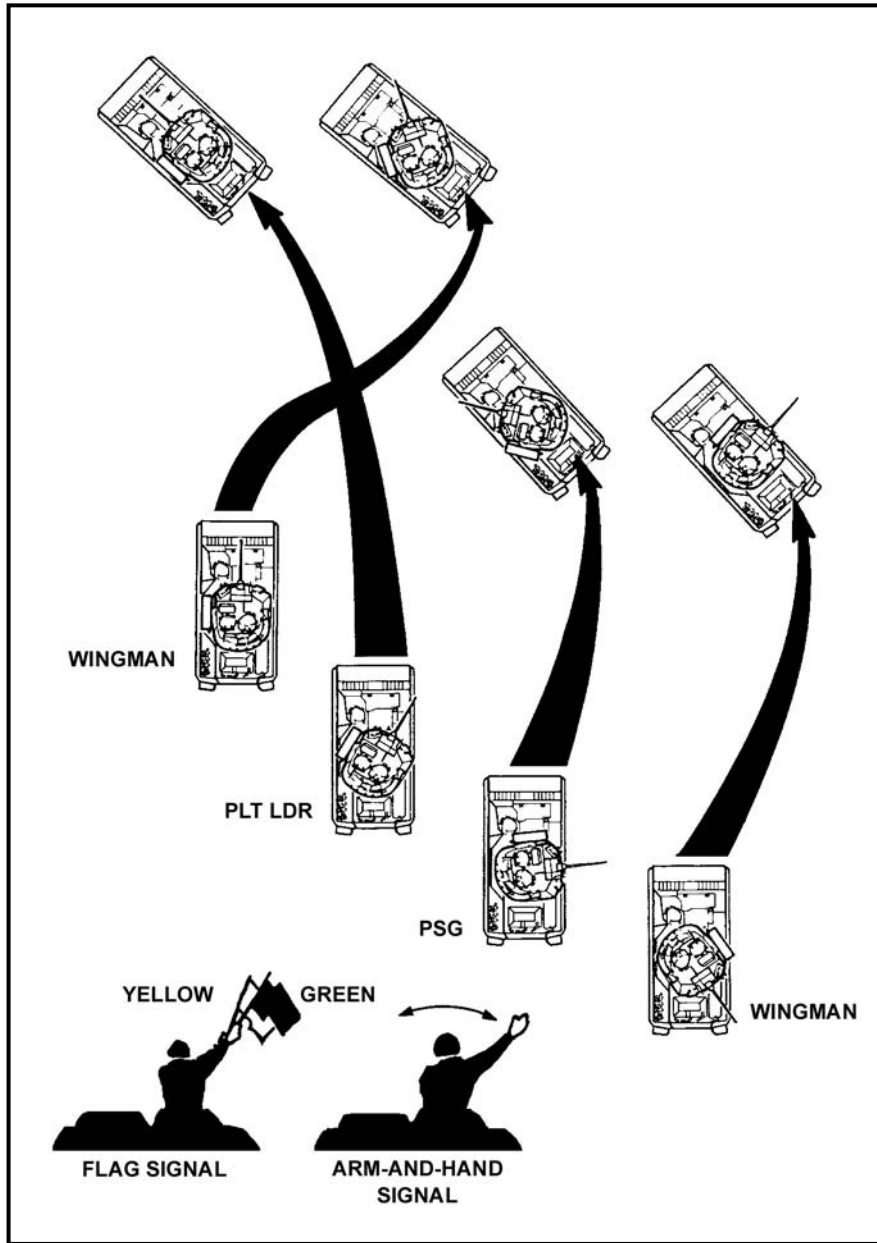

Figure E-31. Echelon to column formation.

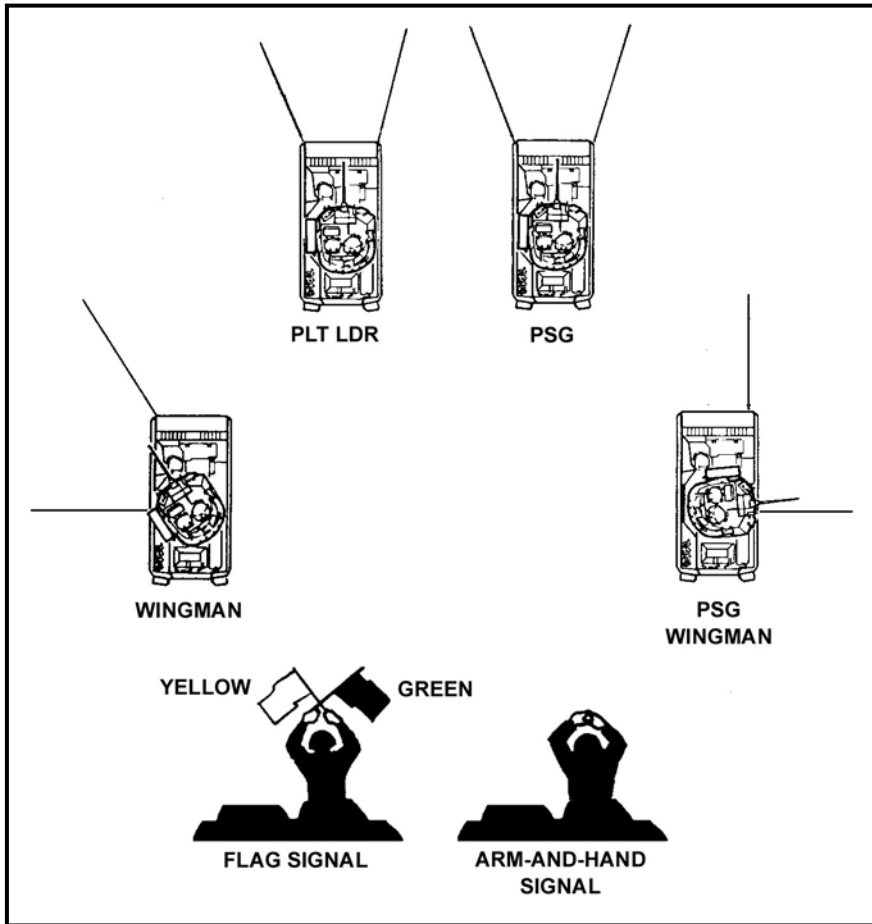

Figure E-32. Wedge formation.

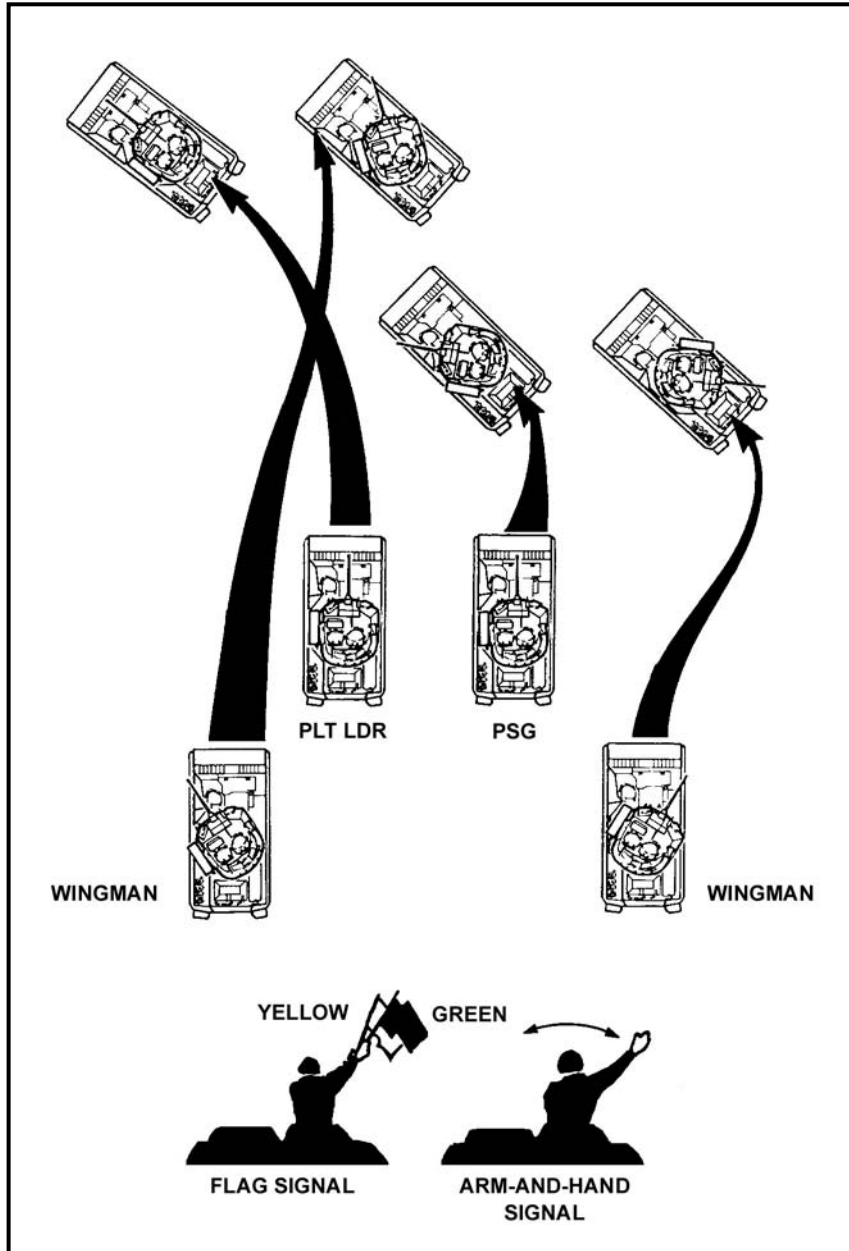

Figure E-33. Wedge to column formation.

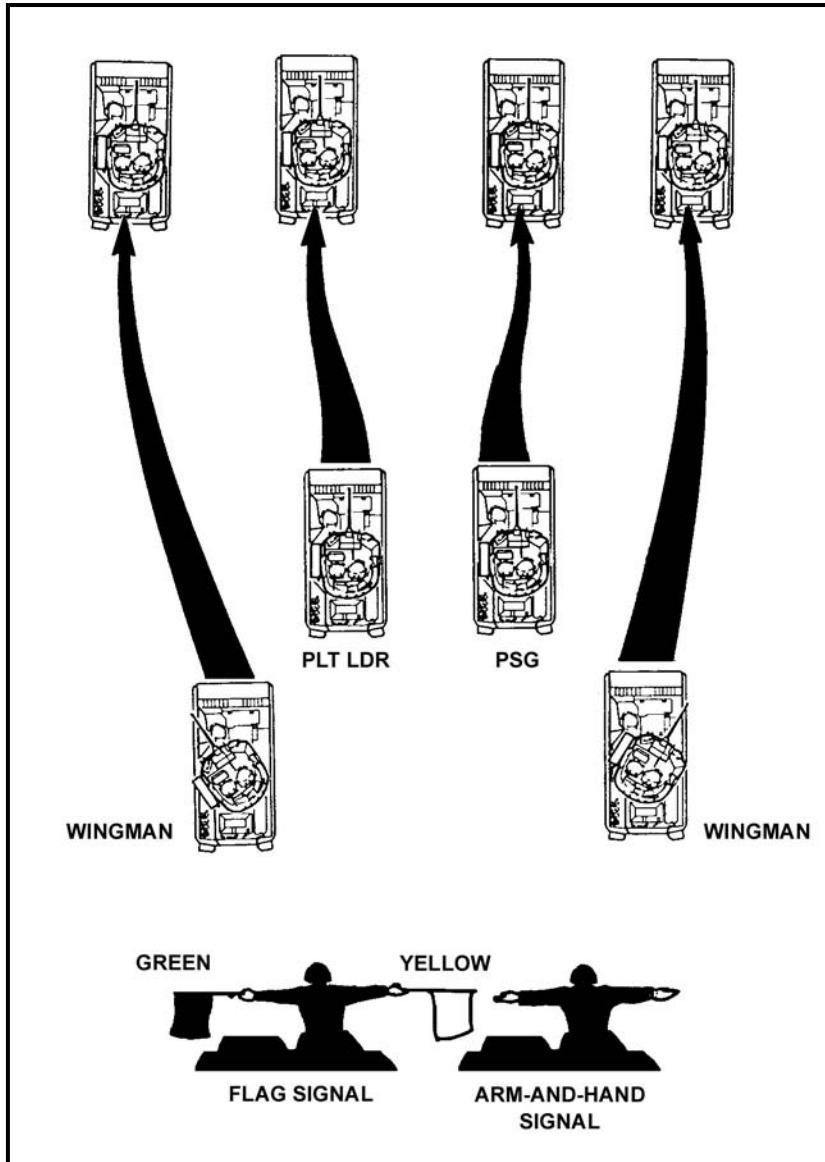

Figure E-34. Wedge to line formation.

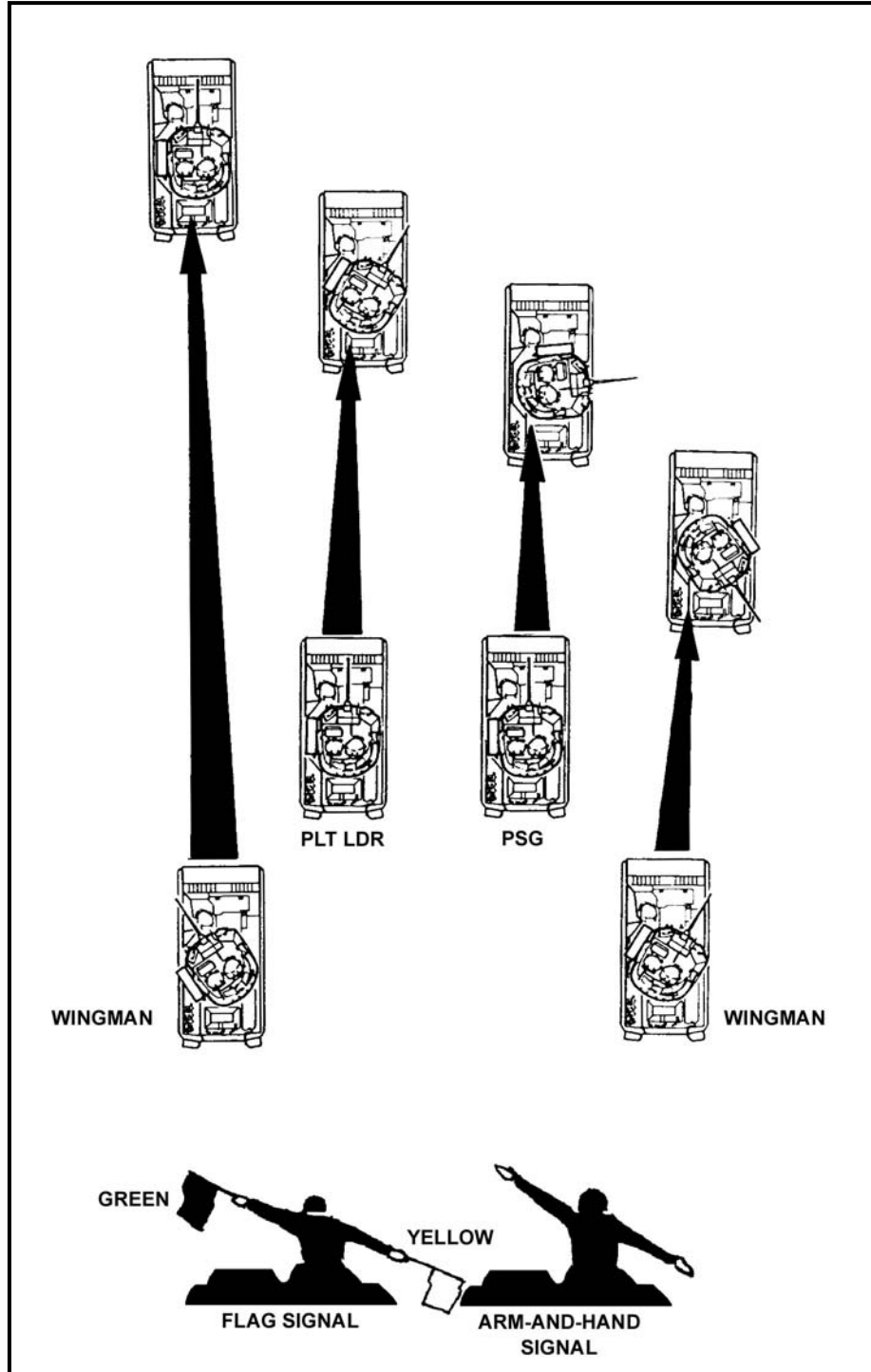

Figure E-35. Wedge to echelon formation.

Crew Drill 7
SECURE AT THE HALT (PLATOON)

SITUATION: The platoon is moving and must halt.

REQUIRED ACTIONS (Figures E-36 through E-39, pages E-65 through E-68):

1. The platoon leader gives the arm-and-hand signals for herringbone or coil formation.
2. The platoon halts in the herringbone or coil formation.
3. Each BC ensures his vehicle is correctly positioned, using cover and concealment.
4. The gunner orients his turret and raises the TOW launcher and observes his sector of fire.
5. The platoon leader orders the squads to dismount and provide local security. (Dismount IAW with the task, Dismount the Vehicle.)
6. The fire team occupies a hasty fighting position as designated by the team leader in the vicinity of their respective BFV. The squad leader contacts the team leader and adjusts security positions as necessary.
7. Soldiers continue to observe designated sectors.

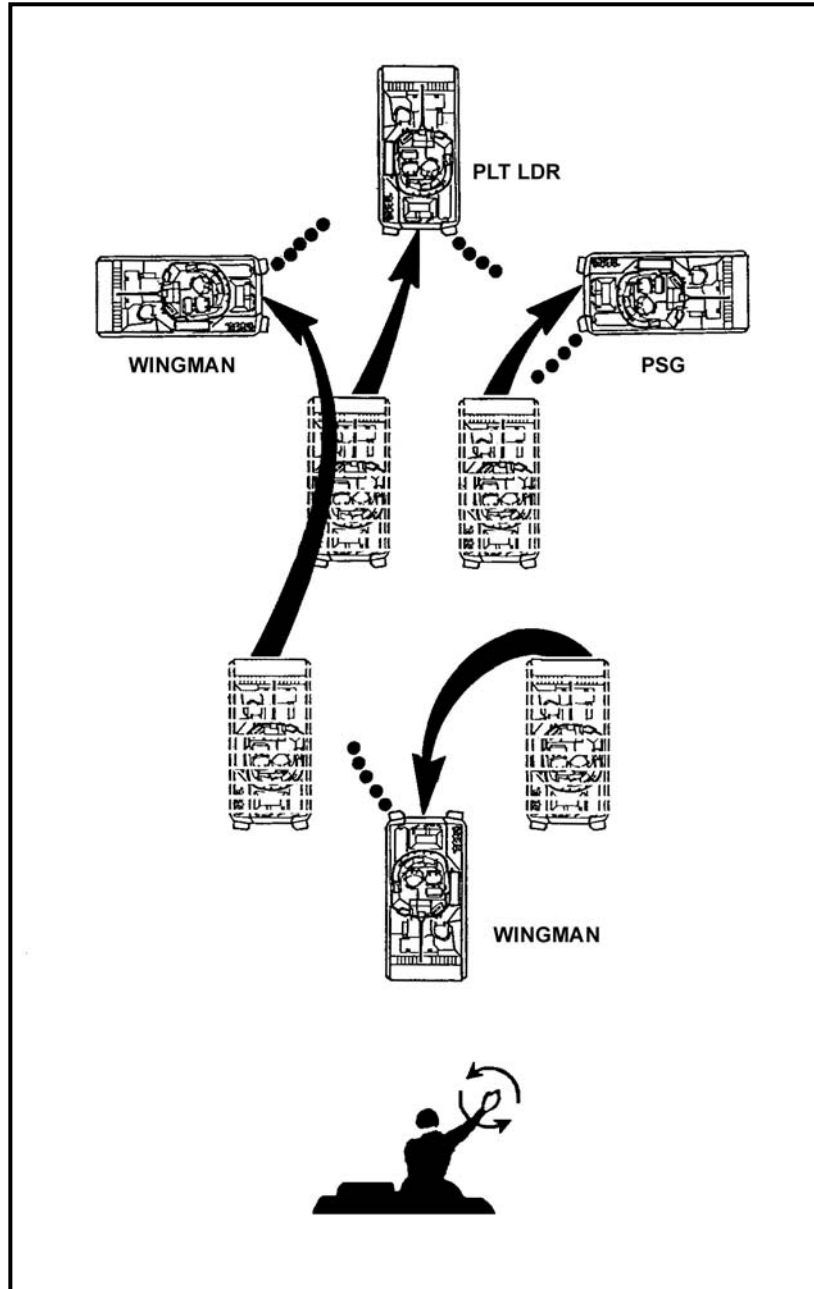

Figure E-36. Wedge to coil formation.

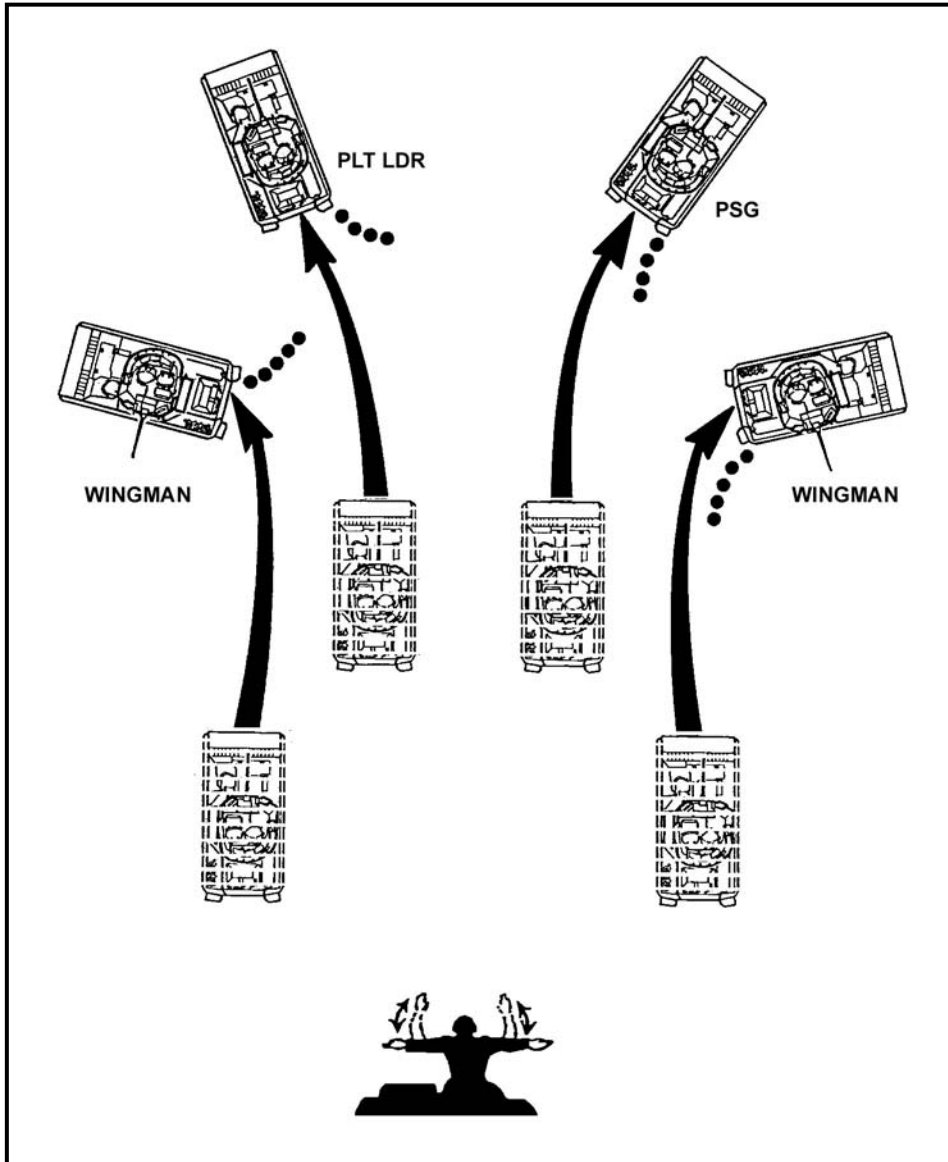

Figure E-37. Wedge to herringbone formation.

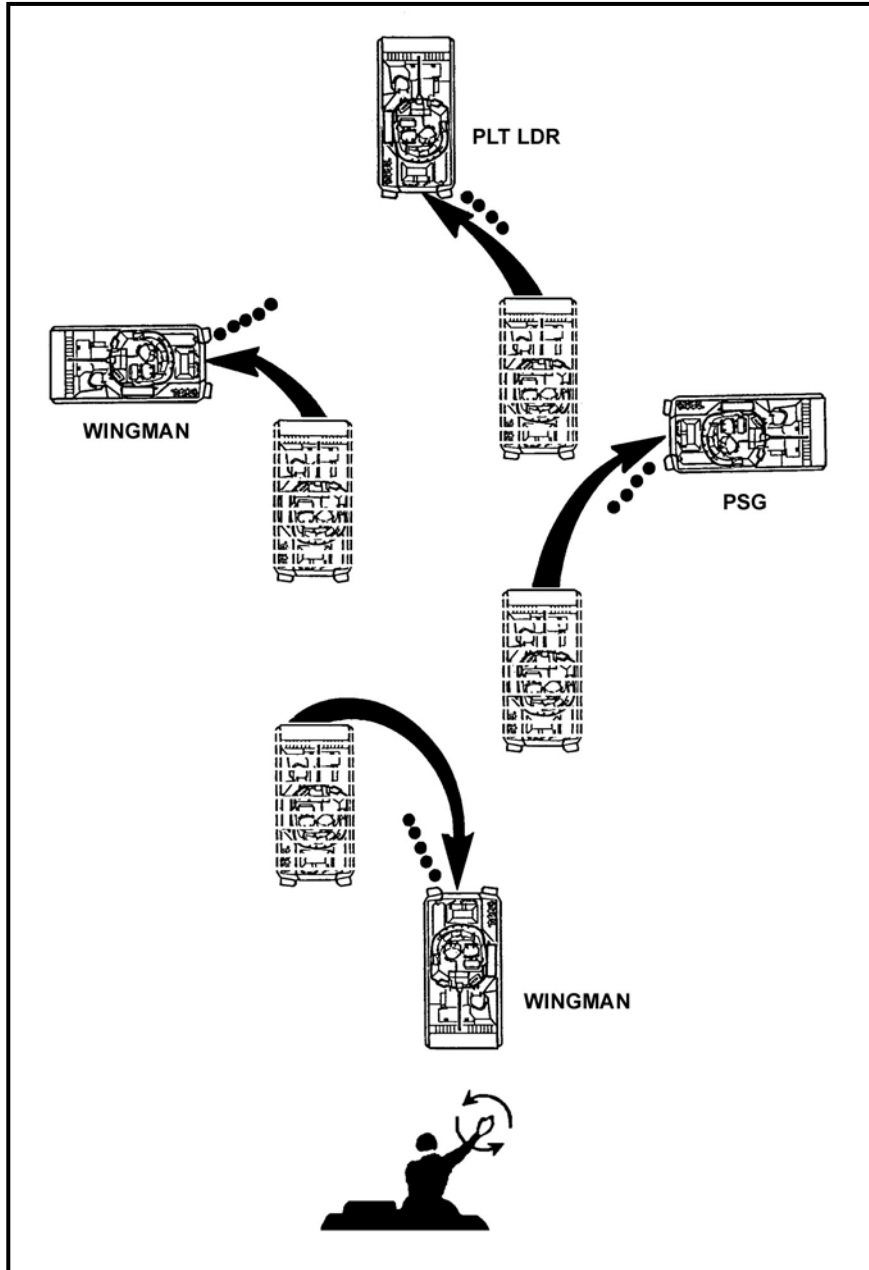

Figure E-38. Column to coil formation.

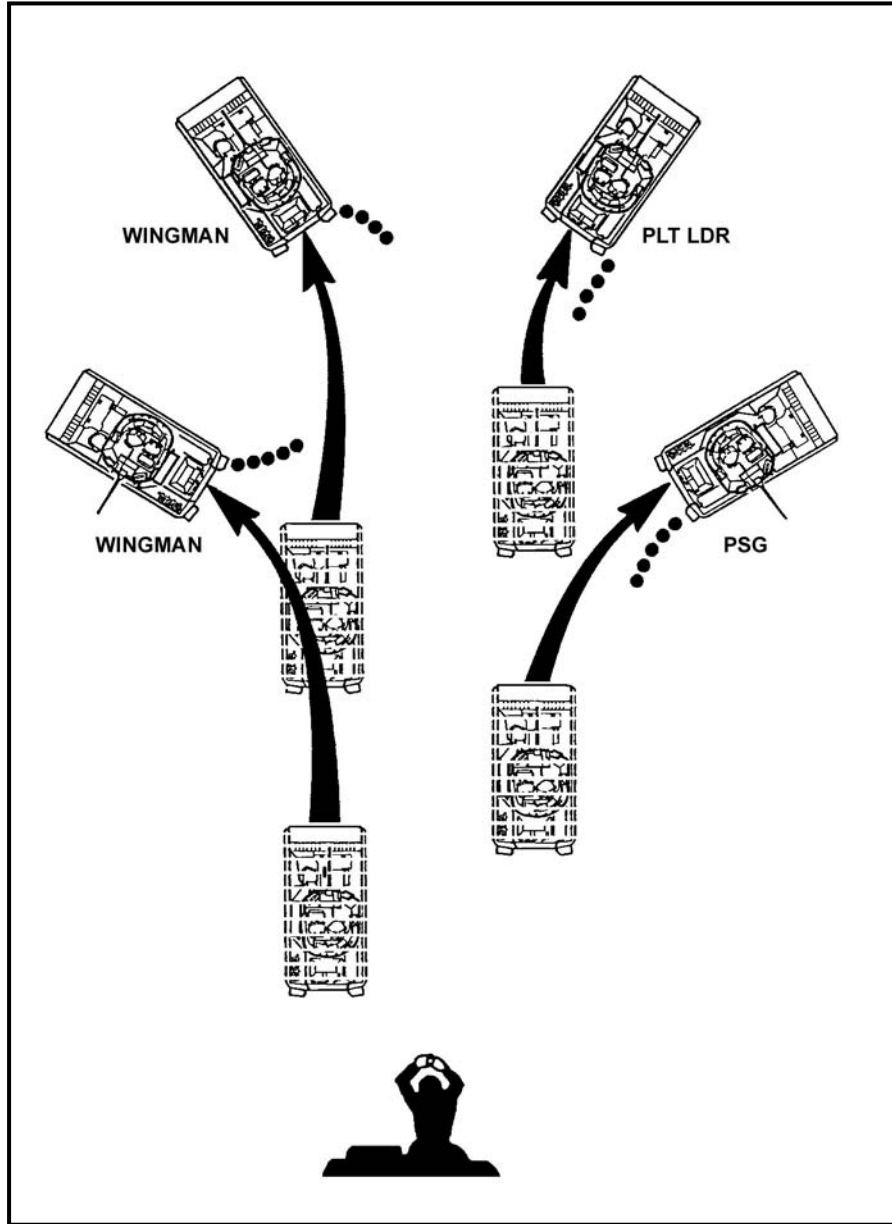

Figure E-39. Column to herringbone formation.

Crew Drill 8
EXECUTE ACTION RIGHT OR LEFT (PLATOON)

SITUATION: The platoon is moving and must execute action right or left.

REQUIRED ACTIONS (Figures E-40 through E-47, pages E-70 through E-77):

1. The platoon leader signals action right or left using arm-and-hand, flags, or radio.
2. The drivers immediately execute a turn in the direction indicated while moving into a line formation.
 - a. The platoon sergeant orients his vehicle on the platoon leader's vehicle.
 - b. Wingmen orient their BFVs on the platoon leader and platoon sergeant vehicles.
3. The platoon leader orders the BCs to seek covered positions for their vehicles or have them continue to move in the direction indicated.
4. The BCs orient the main weapons toward the enemy, and the BCs and gunners search for targets.
5. The platoon leader determines if it is necessary to dismount the rifle squads.
6. The platoon leader reports the situation to the company commander, if necessary.

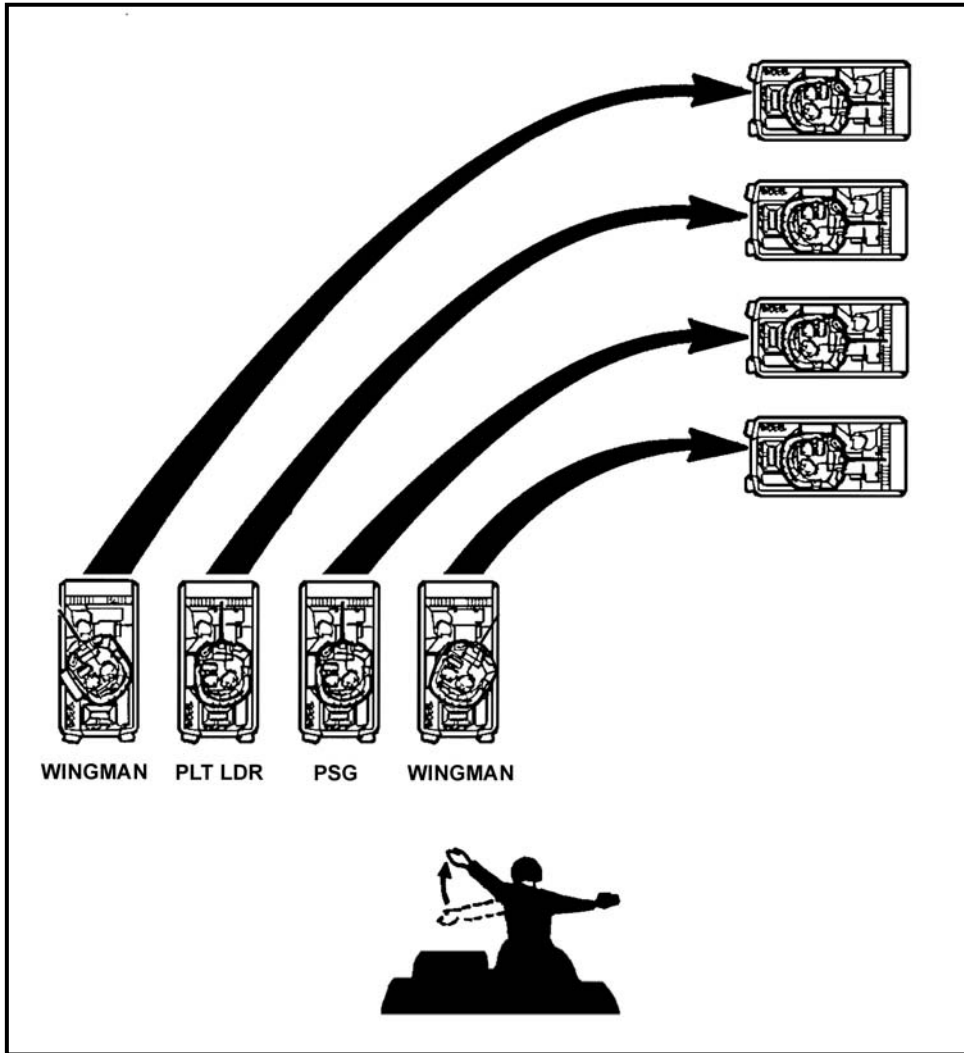

Figure E-40. Action right from line.

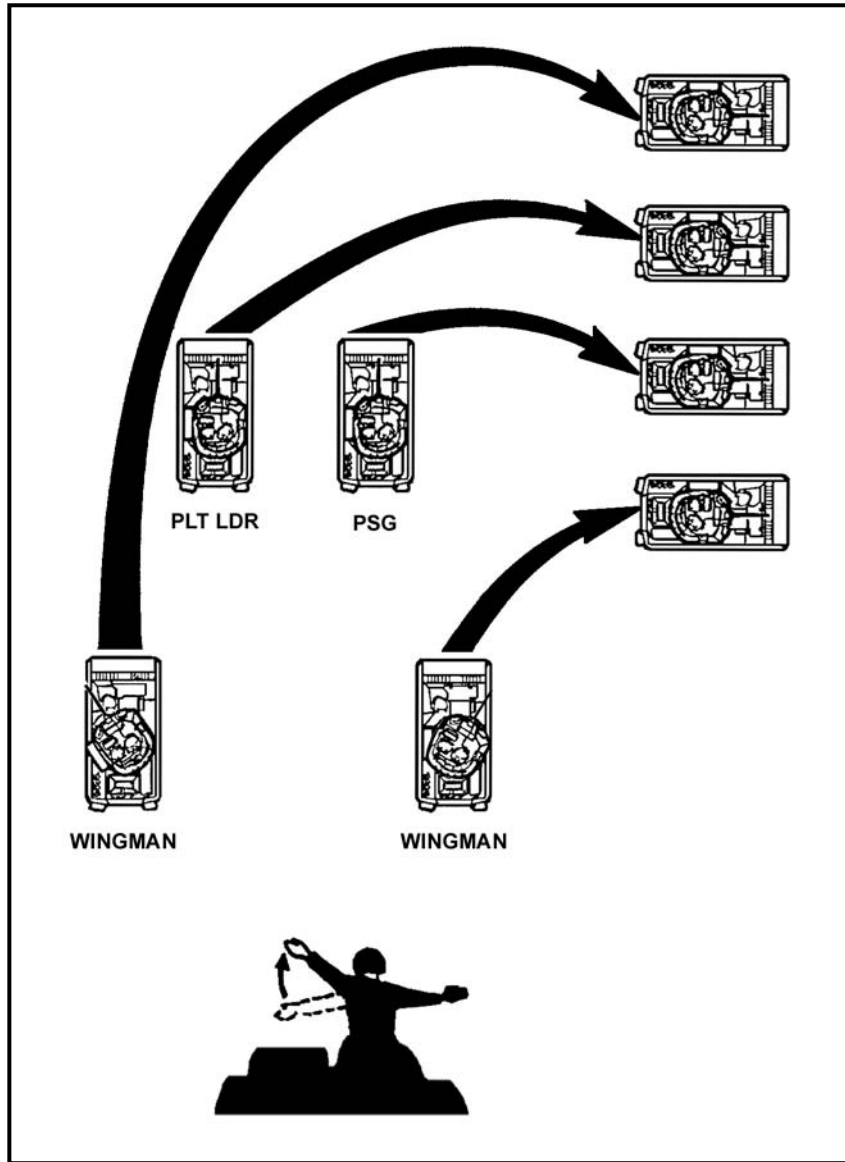

Figure E-41. Action right from wedge.

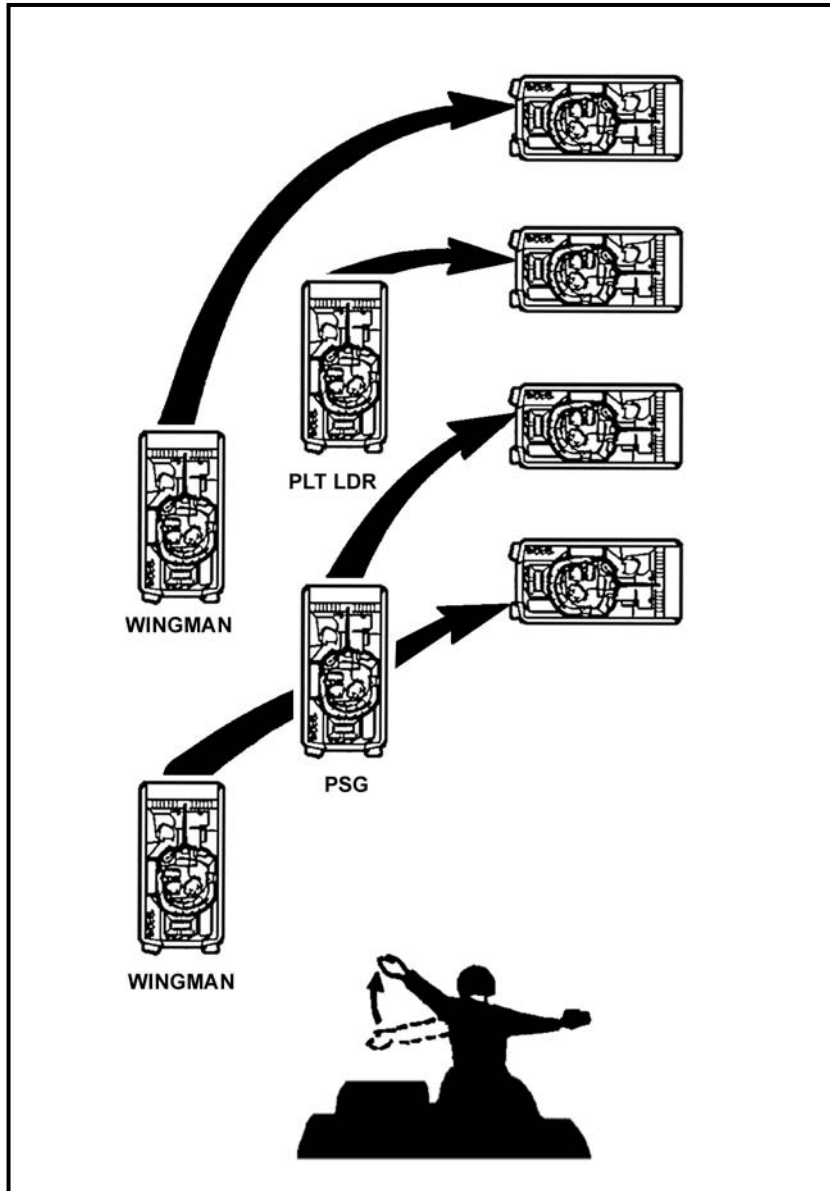

Figure E-42. Action right from column, wingman on left.

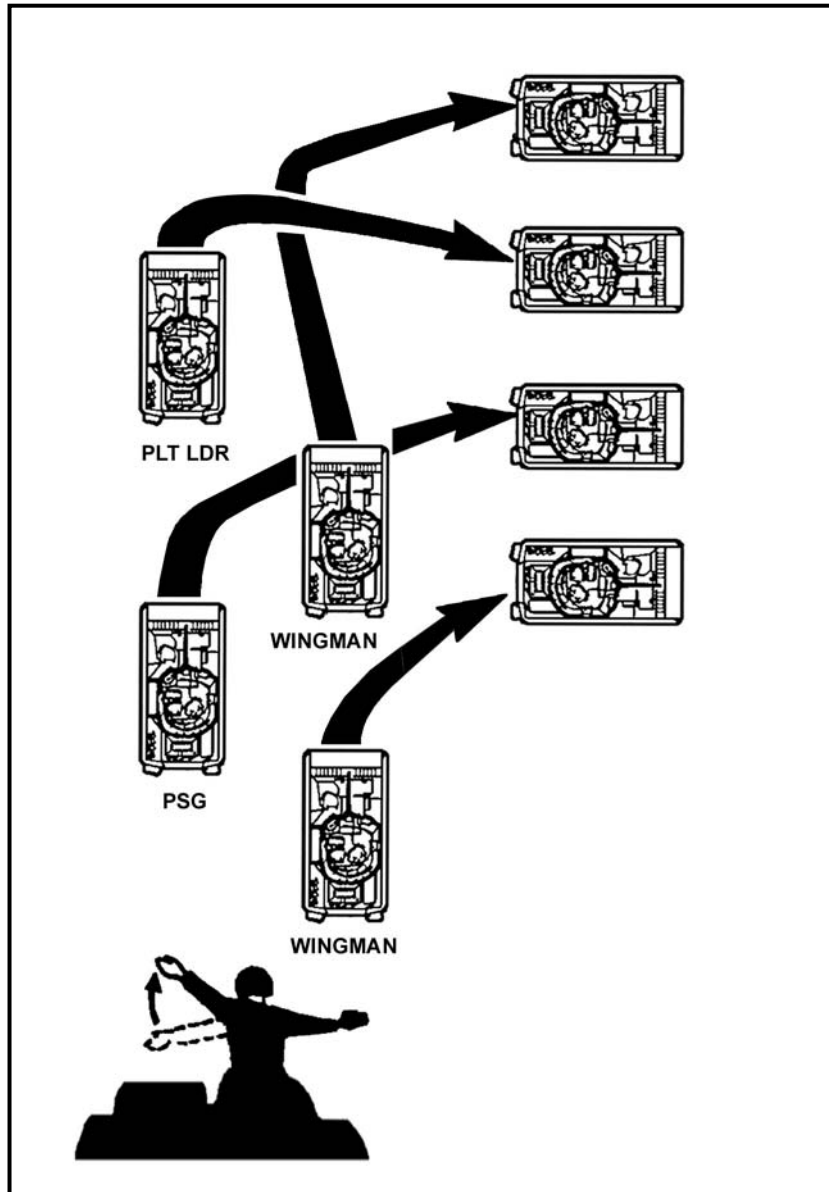

Figure E-43. Action right from column, wingman on right.

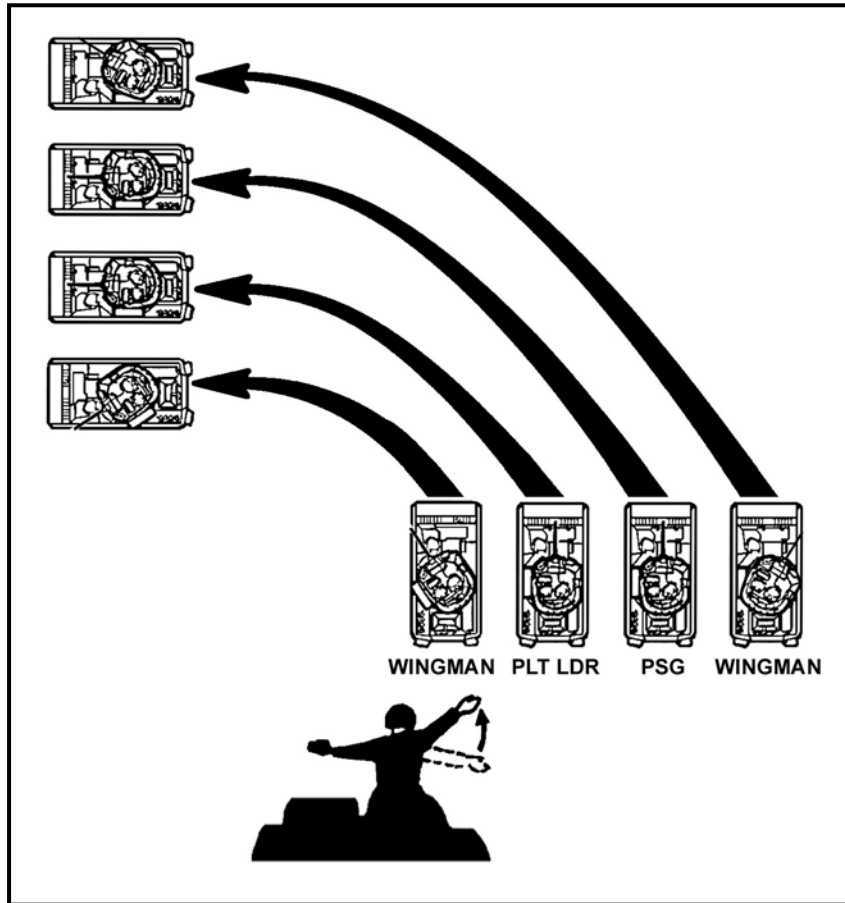

Figure E-44. Action left from a line.

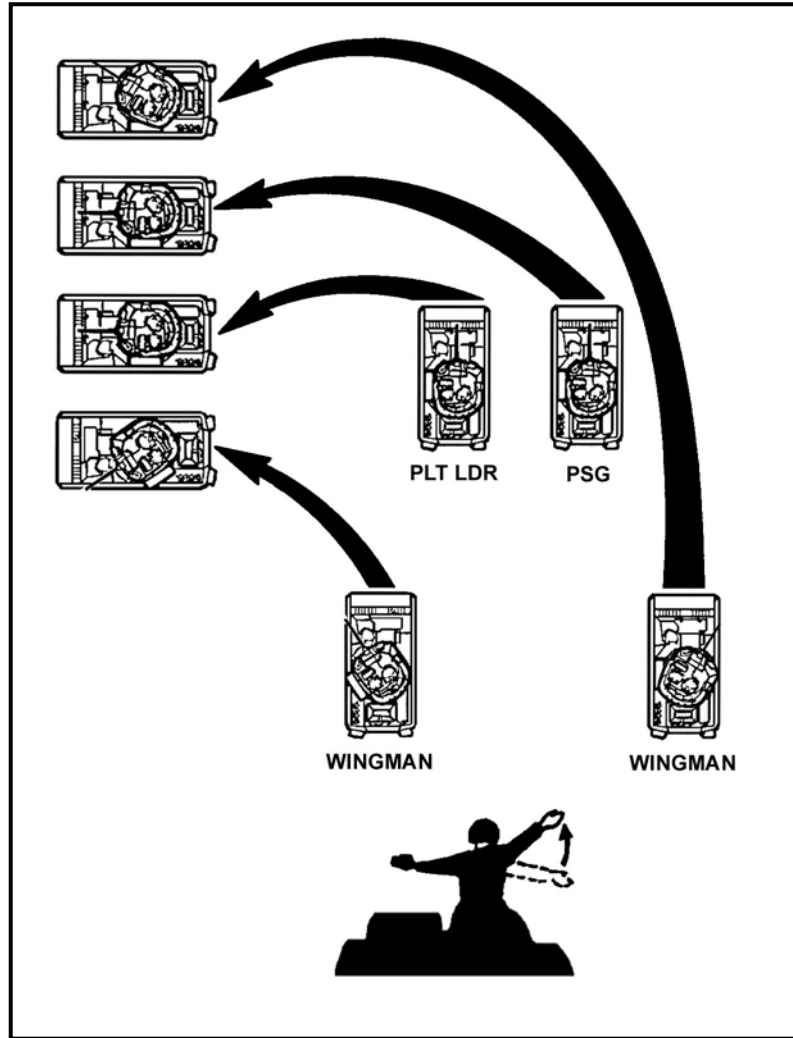

Figure E-45. Action left from a wedge.

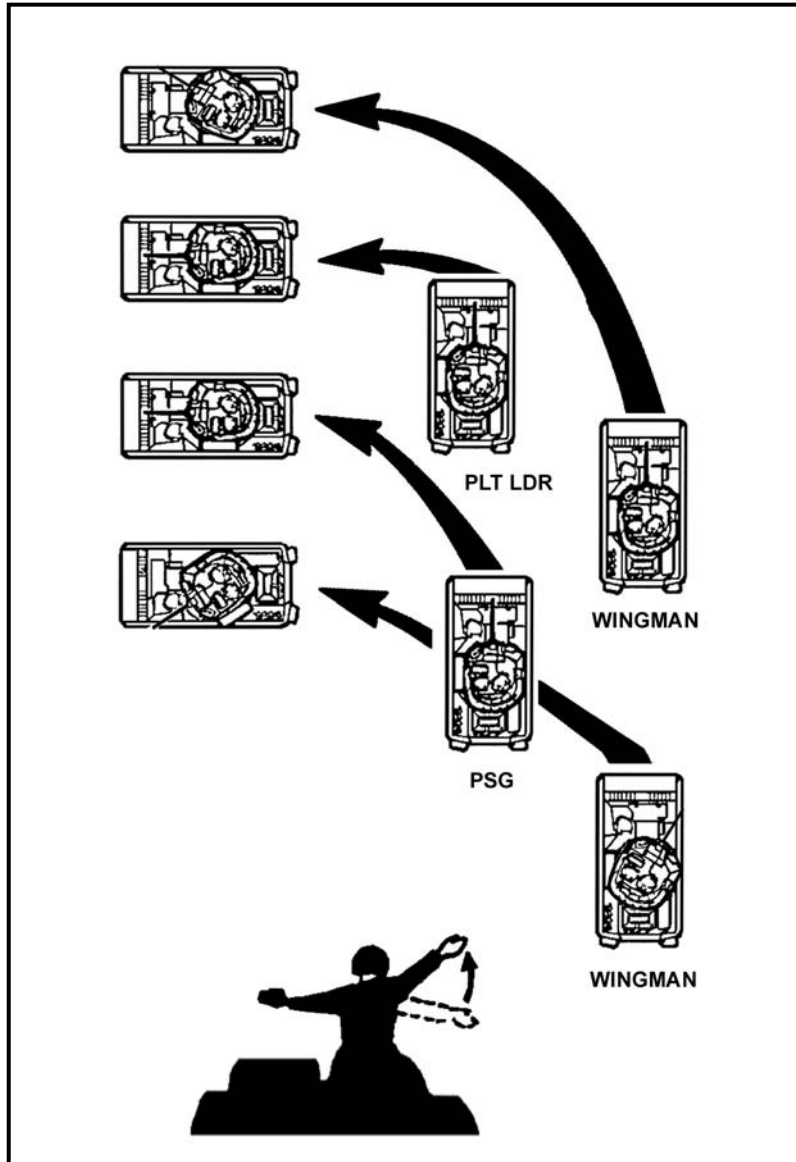

Figure E-46. Action left from a column, wingman on right.

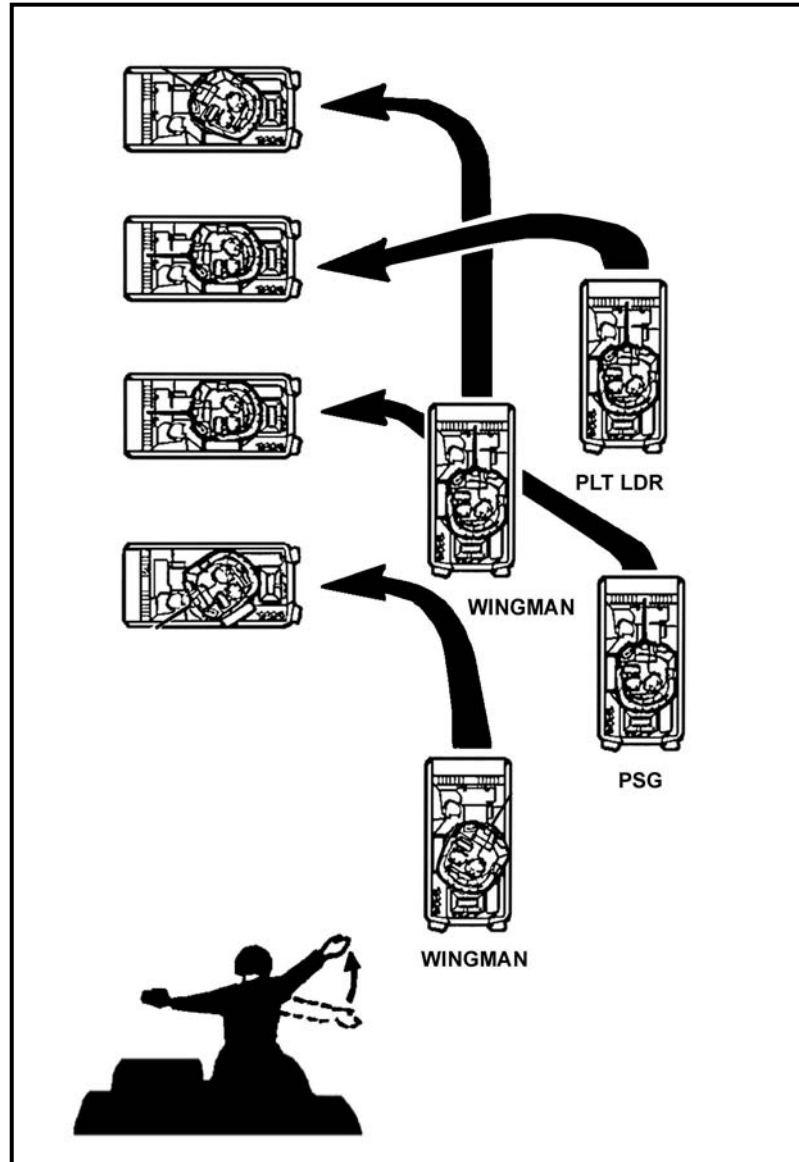

Figure E-47. Action left from a column, wingman on left.

Crew Drill 9
LOAD THE 25-MM LARGE AMMUNITION READY BOX WITH HE

SITUATION: During initial loading or when the low ammunition light comes on. Given a BFV with the ramp up, master power is ON, with 300 rounds of 25-mm ammunition in 30-round boxes (A2 and below) or 50-round “hot boxes” (A2-ODS and A3) stored in accordance with the load plan (25-mm HE or AP).

REQUIRED ACTIONS:

Load the 25-mm HE Ammunition

1. **Gunner:** Traverses the turret to large ammunition can (2150 mils); announces when he has set the turret travel lock.
2. **Bradley Commander:**
 - a. Instructs the driver to lower the ramp. BC announces, UPLOAD HE.
 - b. Sets the turret drive switch to the OFF position.

NOTE: In the absence of a fire team member, the BC or gunner must perform the task of loading.

3. **Fire Team Member:** The fire team member performs the duties of the loader.
 - a. Opens the turret shield door.
 - b. Opens and removes the door from the large ammunition can.
 - c. Removes the floor plates.
 - d. Prepares the HE ammunition for loading.
 - (1) Unstows the HE ammunition.
 - (2) Conducts a quick visual inspection to ensure it is undamaged, clean, and aligned.
 - (3) Joins 15-round ammunition belts and loads 30 rounds at a time until there are 230 rounds loaded into the large ammunition-ready can.

NOTE: An ammunition belt must be loaded with the links on the top and the rounds pointed to the right of the vehicle. Count the rounds as they are loaded

- (4) If reloading, checks to see how many rounds are remaining in the ammunition can. There must be a single empty link at the end of the ammunition belt.
 - e. Loads the ammunition can IAW the diagram on the ammunition can door.
 - f. Turns the ammunition belt over so that the links are on the top. Rounds should point to the “right” of the vehicle.
 - g. Feeds the ammunition belt with the double links first into the ammunition can. Hangs the first five rounds on the loading rail. Hangs the 19th round on the loading rail.
 - h. Counts the next 25 rounds. Hangs both the 24th and 25th rounds on the loading rail.
4. **Gunner:** Removes the lid from the top of the large ammunition can.
 - a. Pull and locks the upper roller to the rear (right) of the ammunition can.

- b. Forwards the rounds up the feed chute towards the feeder with the 14-mm ratchet wrench.
- c. Slides and locks the upper roller to the left.
5. **Fire Team Member:** Loads the remainder of the rounds in the ammunition can. Hangs every 24th and 25th round.
6. **Gunner:** Removes the small access door and lifts the ammunition belt loops over the baffles until rounds are hanging straight up and down. Reinstalls the access door.
7. **Fire Team Member:** Installs and closes the large ammunition can door.
 - a. Ensures the HE-AP-919 selector switch is set to HE.
 - b. Closes the turret shield door, and taps on the shield door and announces, HE UPLOADED.
 - c. Stows empty ammunition boxes.
 - d. Replaces floor plates and unstows seats.

Load the 25-mm AP Ammunition

8. **Gunner:** Traverses the turret to the small ammunition can (4350 mils). Announces when he has set the turret travel lock.
9. **Bradley Commander:**
 - a. Instructs the driver to lower the ramp. Announces, UPLOAD AP.
 - b. Sets the turret drive switch to the OFF position.

NOTE: In the absence of a fire team member, the BC performs the fire team member duties.

10. **Fire Team Member:** The fire team member performs the duties of the loader.
 - a. Opens the turret shield door.
 - b. Opens and removes the door from the small ammunition can.
 - c. Removes the floor plates.
 - d. Prepares the AP ammunition for loading.
 - (1) Unstows the AP ammunition.
 - (2) Conducts a quick visual inspection to ensure it is undamaged, clean, and aligned.
 - (3) Joins and loads the ammunition in 30-round belts until 70 rounds are loaded into the small ammunition can.

NOTE: An ammunition belt must be loaded with the links on the top and the rounds pointed to the left of the vehicle. Count the rounds as they are loaded.

- (4) If reloading, checks to see how many rounds are remaining in the ammunition can. There must be a single empty link at the end of the ammunition belt.
 - d. Hangs the first round onto the load rail, then hangs the 25th and 26th rounds onto the loading rail.
 - e. Lifts the single linked end of the ammunition belt up into the forwarder. Pushes the last round until it is engaged in the sprocket.
11. **Gunner:** Locks the upper roller to the rear of the ammunition can.
 - a. Forwards the rounds with the 14-mm ratchet wrench.

b. Unlocks the upper roller.

12. Fire Team Member:

a. Installs and closes the small ammunition can door.

b. Ensures the HE-AP-919 selector switch is set to AP.

c. Closes the turret shield door, taps on the shield door, and announces, AP
UPLOADED.

d. Stows empty ammunition boxes.

e. Replaces floor plates and unstows squad seats.

Crew Drill 10
ENGAGE TARGETS WITH THE 25-MM AUTOMATIC GUN
OR 7.62-MM COAX (CREW)

SITUATION: Upon recognition of a target or on the BC's order. With the ISU (IBAS for M2A3 only), the Bradley crew has identified a target.

REQUIRED ACTIONS:

1. **Bradley Commander:** Lays the gun for direction by squeezing the palm switch on the commander's hand station and turning the turret in the general direction of the target. The BC issues a precision or battlesight fire command.
2. **Gunner:**
 - a. Indexes the announced range into the ISU (M2A2 and earlier).
 - b. Selects the ammunition/weapon system on the weapon control box in accordance with the BC's fire command.
 - c. Acquires the target using the ISU/IBAS on LOW magnification.
 - d. Switches to the HIGH magnification and announces "Identified".
 - (1) If the gunner announces "Cannot identify," the BC attempts to identify and gives further instructions.
 - (2) If the gunner announces "Lost," the BC gives additional target location information.
 - (3) If the gunner announces "Friendly," the BC gives a new target location or takes the weapon out of action.
 - (4) If the gunner announces "Cannot engage," the BC designates another target or tells the driver to move the vehicle (for example, "Driver, back, right, stop").
 - e. Lays the reticle on the center of target visible mass.
3. **Bradley Commander:** Commands FIRE.
4. **Gunner:** Announces ON THE WAY, and fires the weapons system.
5. **Bradley Commander:** Commands CEASE FIRE, upon target destruction to end the engagement.

Crew Drill 11
RELOAD A TOW LAUNCHER (CREW)

SITUATION: The BFV has fired two TOW missiles and needs to be reloaded. The TOW casings are in the launch tubes. The TOW launcher is raised.

REQUIRED ACTIONS:

1. **Bradley Commander:** Commands PREPARE TO LOAD MISSILE
2. **Gunner:**
 - a. Traverses the turret to the TOW LOAD position (5950 mils).
 - b. Moves the ARM-SAFE-RESET switch to RESET then to the SAFE position.
 - c. Elevates the launcher to 500 mils.
3. **Bradley Commander:** Moves the turret drive switch to OFF.
4. **Gunner:** Engages the turret travel lock.
5. **Fire Team Member:** The fire team member in the No. 5 seat is responsible for reloading the TOW missiles.

NOTE: In the absence of soldiers in the troop compartment, the BC acts as the loader, depending on the unit's SOP. In the absence of the BC, the gunner assumes the responsibilities of the BC.

- a. Unstows the missiles.
- b. Checks the humidity indicator(s) on the stowed missile. (If the humidity indicators are pink, do not use.)
- c. Inspects the containers for damage.
- d. Removes the forward handling rings from the nose end of the stowed missiles.
- e. Removes the electrical connector covers from the stowed missiles.
- f. Checks the nose ends and rear diaphragms.
6. **Bradley Commander:** Commands LOAD MISSILE.
7. **Fire Team Member:**
 - a. Leader announces, UPLOADING TOW.
 - b. Opens the cargo hatch cover to the TOW LOAD position.
 - c. Pushes the release button on the side of the locking handle and pulls down.
 - d. Removes the expended missiles.
 - e. Ensures the umbilical connectors do not extend down into the TOW launcher.
 - f. Loads the missiles into the launcher (outside tube first).
 - g. Holds the missile and pushes the locking handle up until it locks.
 - h. Closes the cargo hatch.
 - i. Announces, TOW UPLOADED.
8. **Gunner:**
 - a. Turns the turret drive switch to ON and disengages the turret travel lock.
 - b. Traverses the turret to the target area and arms the system.

Crew Drill 12 ENGAGE TARGETS WITH THE TOW (CREW)

SITUATION: The Bradley crew has identified a target for the TOW within 3,750 meters.

REQUIRED ACTIONS:

1. **Bradley Commander:** Commands GUNNER, MISSILE, TANK, and lays the gun for direction to the target.
2. **Gunner:** Starts searching for the target as the BC lays the gun.
3. **Driver:** Halts the vehicle in a hull-down position.
4. **Gunner:** Selects HIGH magnification and uses the ISU/IBAS to determine if the target can be engaged.
5. **Driver:** Checks the vehicle slope indicator to ensure the vehicle is within the 10-degree slope warning.
6. **Gunner:** Checks the vehicle slope indicator to ensure the vehicle is within the 10-degree slope warning. Places the launcher's UP-DOWN switch on the TOW control panel to UP.
 - a. Depresses the gunner's palm switch to raise the launcher.
 - b. Depresses the TOW button on the TOW control panel.
 - c. Selects the missile tube one or two on the TOW control panel.
 - d. Places the ARM-SAFE-RESET switch to ARM.
 - e. Sights the target, announces, IDENTIFIED, and lays the cross hairs on the center of target visible mass.
 - (1) If the gunner announces "Cannot identify," the BC attempts to identify and gives further instructions.
 - (2) If the gunner announces "Lost," the BC gives additional target location information.
 - (3) If the gunner announces "Friendly," the BC gives the new target description or takes the weapon out of action.
 - (4) If the gunner announces "Cannot engage," the BC designates another target or tells the driver to move the vehicle (for example, "Driver, back, right, stop").
7. **Bradley Commander:** On hearing "Identified," commands FIRE.
8. **Gunner:** On hearing "Fire," announces ON THE WAY, and fires.

Crew Drill 13
REMOVE A MISFIRED TOW (CREW)

SITUATION: With all hatches closed, a TOW launcher raised to the firing position, and a misfired TOW missile. Immediate action has already been performed, or on order from the BC.

REQUIRED ACTIONS:

1. **Gunner:**
 - a. Announces TOW MISFIRE, and indicates the missile that did not fire.
 - b. Moves the ARM-SAFE-RESET switch to RESET, then to SAFE.
 - c. Ensures that stabilization switch is set to ON to keep the weapon pointed downrange while the driver rotates the vehicle.
2. **Bradley Commander:** Directs the driver to seek a covered or hull-down position.
3. **Driver:** Pivot steers the vehicle, either left or right, in accordance with the BC's instructions. Turret remains oriented toward the enemy.
4. **Bradley Commander:**
 - a. Tells the driver to pivot until the turret is at 1600 or 4800 mils.
 - b. Engages the turret travel lock.
 - c. Moves the turret drive system switch and turret power switch to OFF.
5. **Fire Team Members:**
 - a. Two fire team members dismount to the rear of the vehicle.
 - b. One fire team member climbs onto the vehicle from the left side, keeping away from the front and rear of the vehicle.
 - c. Removes the misfired TOW missile from the launcher.
 - d. Hands the misfired missile to the fire team member on the ground.
 - e. Carries the missile a safe distance away from the vehicle. Marks the missile's location.
 - f. Lays the missile so that the backblast area is least destructive (minimum 200 meters).
 - g. Puts a clearly visible stake and yellow flag at the misfired TOW missile location.
6. **Bradley Commander:** Notifies the chain of command of the existence and location of the misfired TOW missile.

Crew Drill 14
LOAD, UNLOAD, AND STOW GRENADES FOR
THE M257 SMOKE GRENADE LAUNCHER (CREW)

SITUATION: On order of the BC, the crew loads the eight smoke grenades stowed in the smoke grenade storage bins.

REQUIRED ACTIONS:

1. **Gunner:** Traverses the turret to the 6400-mil position and sets the turret travel lock.
2. **Bradley Commander:** Turns the turret drive system switch and the turret power switch to OFF.
3. **Driver:** Ensures that the master powers witch is OFF.
4. **Bradley Commander:** Commands LOAD SMOKE GRENADES.
5. **Bradley Commander or Gunner:**
 - a. Exits the turret from the gunner or BC hatch.
 - b. Removes expended grenades from the launcher.
 - c. Checks each launch tube for damage and debris.
 - d. Lifts the grenades (four) from the stowage bin; inspects the grenades.
 - e. Loads the launcher by sitting on the stowage bin and straddling the launcher.
 - f. Loads the grenades, metal end down, from bottom to top. Gently push on the smoke grenade until two clicks are felt, then turns it one-half turn.
 - g. Assumes the assigned seat in the turret.
6. **Bradley Commander:** Commands UNLOAD THE SMOKE GRENADE LAUNCHER. Turns the turret drive and turret power switches to OFF.
7. **Driver:** Turns the master power to OFF.
8. **BC or Gunner:** Sitting on stowage bin, removes the four discharger caps and grenades from top to bottom.
 - a. Installs the discharger caps on the grenade launcher tubes.
 - b. Opens the bins to stow the grenades.
 - c. Stows the grenades metal end down.
 - d. Closes and latches the smoke grenade stowage bin.

Crew Drill 15
DESTROY OR ABANDON A
BRADLEY FIGHTING VEHICLE (CREW)

SITUATION: Given an order to destroy or abandon the BFV, 15 one-pound blocks of TNT (or equivalent), equipment to complete an electric or nonelectric firing circuit, or two incendiary grenades, and a vehicle crew and a fire team.

REQUIRED ACTIONS:

1. **Destruction by Removal or Destruction of Main Components.**
 - a. **Bradley Commander:**
 - Removes the 7.62-mm coaxial machine gun backplate and destroys it.
 - Smashes the radios.
 - Smashes the CIV (M2A3 only).
 - Secures his protective mask, and individual weapon, gear, and the night vision goggles.
 - b. **Gunner:**
 - Takes the bolt assembly from the 25-mm automatic gun.
 - Smashes the ISU/IBAS.
 - Secures his protective mask, and individual weapon and gear; and evacuates the vehicle.
 - c. **Driver:**
 - Cuts the coolant lines.
 - Cuts the engine oil hose.
 - Smashes the AN/VVS-2 night vision viewer or drivers vision enhancer (DVE) (M2A3 only).
 - Secures his protective mask, individual weapon and gear.
 - d. **Team Members:**
 - Secures all night vision devices.
 - Secures dismounted radio.
 - Secures their protective mask, and individual weapons and gear; and evacuates the vehicle.
2. **Destruction by Fire.**
 - a. **Bradley Commander:**
 - Traverses the turret to 4100 mils.
 - Secures his protective mask and individual weapon.
 - b. **Driver:**
 - Discharges the Halon bottle in the engine compartment.
 - Lowers the ramp; opens the power unit access door.
 - Opens the main fuel manual shutoff valve and main fuel drain valve, and cuts the fuel lines.
 - Secures his weapon and protective mask, and evacuates the vehicle.
 - c. **Fire Team Members:**
 - Open the cargo hatch.
 - Secure the weapon and protective mask, and evacuates the vehicle.

- Discharge the Halon bottle; removes and empties the portable fire extinguishers.
- d. **Bradley Commander:**
- Secures two incendiary grenades.
 - Places one grenade in the power unit and one in the crew compartment, and evacuates the vehicle.
3. **Destruction by Antiarmor Fire.** The BC—
- Has the team members dismount with protective masks, individual weapons, and light antitank weapons (AT4s).
 - Has the antiarmor specialist secure the Javelin CLU and missiles.
 - Moves the team past the minimum range of the Javelin (65-75 meters) and within maximum range of the AT4 (300 meters).
 - Directs a volley of fire, aiming at the armament, engine, and drive train components.
4. **Destruction by Demolition.**
- a. **Gunner:**
- Prepares three 1-pound blocks of TNT or the equivalent.
 - Places the charges as follows:
 - On the receiver of the 7.62-mm coax.
 - On the receiver of the 25-mm.
 - On the ISU/IBAS.
- b. **Driver:**
- Prepares six 2-pound charges using 1-pound blocks of TNT or the equivalent.
 - Places the charges as follows:
 - One charge on the accessory end of the engine.
 - The second and third charges on the engine—one on the left side and the other on the right side.
 - The fourth charge between the engine and the cross drive transmission.
 - The fifth and sixth charges on the left and right track drive sprockets.
- c. **Bradley Commander:**
- Provides for dual priming to minimize the possibility of a misfire.
 - Connects all charges (the charges for the turret and engine compartment) for simultaneous detonation.
 - Moves team members (with protective masks and individual weapons) to a covered area.
 - Detonates the charge.
- NOTE:** Ammunition and equipment that are not destroyed by the detonation should be removed from the vehicle and destroyed by other methods.
5. **Destruction by Using Natural Surroundings.** The team members—
- Remove the major components (backplate from the 7.62-mm coax, the bolt from the 25-mm main gun) and submerge them in water (lakes, ponds, rivers, and so forth). If possible, submerge the vehicle.

- If no body of water is near, widely disperse components (backplate from the 7.62-mm coax, the bolt from the 25-mm main gun), preferably into heavy underbrush.
- Break down the bolt and track assembly before disposing of the parts. The BC or gunner keeps the firing pin assembly.

Crew Drill 16
PERFORM BEFORE-, DURING-, AND AFTER-COMBAT
OPERATION CHECKS (CREW)

SITUATION: Occurs during assembly area procedures, after an engagement, or during consolidation and reorganization.

REQUIRED ACTIONS:

1. **Before-Combat Operation Checks.**

NOTE: Follow all safety procedures while working in and around the turret, and ensure that no weapons are loaded with ammunition when performing the before-operation checklist.

- a. **Squad Leader** (personally or through coordination with the team leaders)—
 - Checks to ensure that all personnel are properly wearing personal protective equipment IAW the unit SOP and commander's guidance (for example, protective mask, protective body armor, helmet, nerve-agent antidote). Ensures that all personnel have hearing protection.
 - Ensures that all personnel have their assigned weapons and the prescribed ammunition load.
 - Checks to ensure that all weapons are loaded and placed on SAFE (to include firing port weapons).
 - Ensures that ammunition and pyrotechnics are properly stowed (for example, grenades, flares, small arms ammunition, smoke, AT4s, Claymores, hand grenades).
 - Ensures that all target acquisition devices (for example, NVD, binoculars, AN/PVS-7, AN/TAS-5) are properly stowed.
 - Ensures that the hand grenades are worn properly.
 - Ensures that all dismount equipment is functional (for example, test fires the weapons, conducts a communications check with the AN/PRC-119).
 - For night operations, ensures that all NVD and other target acquisition equipment (for example, binoculars, AN/PVS-7) are mounted and available, and operational and zeroed to the appropriate weapon for night operations.
 - Ensures that all personnel have additional equipment required to accomplish the mission IAW with METT-TC (for example, minefield marking set, wire cutters, obstacle breach kit).
 - Reports the status of the squad to the platoon sergeant.
 - Ensures all personnel and vehicles are camouflaged.
- b. **Gunner or Bradley Commander.** Ensures the following before-combat-operation checks are performed:
 - Ensures that the weapons systems are on SAFE (electrical and manual).
 - Ensures that all vehicle weapons systems are properly installed, and the prescribed ammunition is uploaded and stowed IAW the stowage and strapping diagram, vehicle load plan, and platoon SOP.

- Ensures all turret weapons systems are operational and boresighted. Conducts a prefire checklist in accordance with the standards outlined in FM 23-1.
- Ensures the vehicle communications systems are operational.
- Ensures that the turret PMCS has been conducted IAW TM 9-2350-252-10-2 and TM 9-2350-284-10-2.
- Checks individual equipment and weapons of the driver and gunner.
- Reports the status of the vehicle to the BC or section leader.

NOTE: During training, in the event the override system is inoperable and the turret interlock system malfunction, the turret drive system should not be used, until it is repaired or fully operational.

c. ***Driver:***

- Conducts before-operation hull PMCS in accordance with TM 9-2350-252-10-1 and TM 9-2350-284-10-1.
- Reports the status of the vehicle to the BC.

d. ***Platoon Sergeant:***

- Consolidates the reports from the squad leaders and BCs, and reports the platoon's status to the platoon leader.
- Checks the aidman for complete aid bag.
- Checks the FIST for individual weapons and equipment; operational mission equipment (for example, laser range finder); operational communications (for example, digital message device and radios); any other mission-essential equipment.
- Other attachments as required.

e. ***Platoon Leader:***

- Checks the special equipment required to execute the mission, and designates where it will be carried.
- Reports the platoon status to the company commander NLT the mission start time.

2. **During-Combat Operation Checks.** During-combat operation checks should be conducted in a secure location during a lull in the battle.

a. ***Squad Leader or Team Leader:***

- Ensures the accountability of all soldiers and equipment.
- Supervises aid to injured soldiers.
- Ensures the weapons are on SAFE.
- Checks ammunition status, gets more ammunition from vehicle if possible, cross levels when necessary, and reports the critical shortages to the platoon sergeant.
- Reports the status of personnel, equipment, and ammunition to the platoon sergeant.
- Ensures dismounted security is established.

-
- b. **Bradley Commander or Gunner:**
- Places the turret system on electrical SAFE.
 - Checks ammunition status for all turret weapon systems, performs reload drills when required, cross levels from other BFVs when necessary, and reports the critical shortages to the section leader or platoon sergeant.
 - Verifies the boresight of all weapons systems.
 - Checks for damaged equipment.
 - Ensures communications (radios and intercommunications) are operable.
 - Conducts a visual inspection of the turret.
 - Ensures the commander's and gunner's handstations are operable.
 - Performs during-operation turret PMCS in accordance with TM 9-2350-252-10-2 and TM 9-2350-284-10-2.
 - Reports the status of the vehicle to the section leader or BC.
 - Supervises expedient vehicle repairs, if necessary.
- c. **Driver:**
- Performs during-operation hull PMCS in accordance with TM 9-2350-252-10-1 or TM 9-2350-284-10-1.
 - Conducts a visual inspection of the exterior of the vehicle.
 - Checks all bolts and nuts on the road wheels and idle wheels.
 - Checks fuel status and oil levels in the engine, transmission, fan tower, final drive ramp motor, road wheels, return roller hub windows, and idler wheels.
 - Checks the engine compartment for any visible signs of damage.
 - Reports the status to the BC.
- d. **Platoon Sergeant:**
- Reports the status of the platoon to the platoon leader.
 - Supervises the evacuation of casualties.
 - Reports the location and status of inoperative vehicles and the WIA or KIA to the platoon leader.
 - Coordinates for resupply, if required (for example, POL, ammunition).
- e. **Platoon Leader:**
- Reports the status of the platoon to the company commander (if resupply or repairs are necessary to complete the mission, if required by SOP, or if the platoon has suffered combat or maintenance vehicle losses).
3. **After-Combat Operation Checks.** After-combat operation checks are to be forwarded in conjunction with consolidation and reorganization, and the infantry is normally dismounted and provides the local security while the BFV crew perform the necessary checks.
- a. **Squad Leader or Team Leader:**
- Ensures that dismounted security is established.
 - Checks for injured soldiers.
 - Accounts for all personnel and equipment.
 - Checks and ensures that all weapons are on SAFE.
 - Reestablishes the chain of command.
 - Checks the status of ammunition and supplies.
-

- Ensures that hasty positions are prepared, ensures that the key weapons are manned, and replaces vehicle crewmembers, as needed.
 - Ensures that soldiers and vehicles are camouflaged as necessary.
 - Reports the status of soldiers, equipment, and ammunition to the platoon sergeant.
- b. **Bradley Commander or Gunner:**
- Places turret system on electrical SAFE.
 - Ensures that ammunition resupply is conducted for all weapons on the vehicle.
 - Conducts a visual inspection of the turret for damages.
 - Checks communications (radios and intercommunications) for damage.
 - Performs after-operation turret PMCS IAW TM 9-2350-252-10-2 or TM 9-2350-284-10-2.
 - Confirms zero with a few rounds.
 - Reports the status of the vehicle to the section leader or BC.
- c. **Driver:**
- Conducts a visual inspection of the vehicle exterior.
 - Performs after-operation hull PMCS IAW TM 9-2350-252-10-1, TM 9-2350-294-10-1 or TM 9-2350-284-10-1.
 - Checks all bolts and nuts on the road wheels and idle wheels.
 - Checks fuel status and oil levels in the engine, transmission, fan tower, final drives, ramp motor and return roller hub windows, road wheels, and idler wheels.
 - Checks the engine compartment for any visible signs of damage.
 - Reports the status to the BC.
- d. **Platoon Sergeant:**
- Reports vehicle, soldiers, equipment, and ammunition status to the platoon leader and company executive officer or first sergeant IAW the unit SOP.
 - Supervises evacuation of wounded soldiers, inoperative equipment, and vehicle.
 - Requests replacements and resupply (personnel, equipment, batteries, POL, ammunition) from the first sergeant IAW the unit SOP.
 - Supervises the repair of equipment and vehicles within the capability.
- e. **Platoon Leader:**
- Determines and disseminates the lessons learned with the platoon sergeant and squad leaders.
 - Reports the platoon status to the company commander.

APPENDIX F
JAVELIN EMPLOYMENT

The Javelin provides accurate, medium-range, antiarmor fire for the BFV-equipped infantry platoon. The Javelin is used in offensive operations to provide precision, long-range direct fires that destroy fortifications and suppress or destroy enemy armored vehicles. In defensive operations, the Javelin may be used to overwatch obstacles, destroy armored vehicles, and force the enemy commander to dismount prematurely, exposing his Infantry to small arms and indirect fires. The Javelin can destroy point targets from medium ranges (65 to 2,000 meters), including helicopters and fortified positions. The platoon leader can also use the Javelin’s thermal sight capability to conduct surveillance of critical avenues of approach in all types of weather. The Javelin may also be used to engage bunkers, buildings, and other fortified targets commonly found during combat in built-up areas.

F-1. THE JAVELIN WEAPON SYSTEM

The Javelin is a dual-mode (top attack or direct fire), man-portable antitank missile with an increased capability to engage and defeat tanks and other armored vehicles (Table F-1). The Javelin has a missile contained in a disposable launch tube/container and a reusable tracker, and is a fire-and-forget weapon system. Additionally, the Javelin has a soft launch that significantly reduces the visual and acoustical signature of the missile.

NOTE: The Javelin will replace the Dragon on a one-for-one basis in infantry and engineer units with no additional changes in current force structure.

Type System:	Fire and Forget
Carry Weight (Total):	49.2 lb (day & night)
Command Launch Unit:	14.1 lb (day & night)
Missile (w/launch tube):	35.2 lb
Crew:	Man portable
Ready to Fire:	Less than 30 sec.
Reload Time:	Less than 20 sec.
Method of Attack:	Top attack or direct fire (top attack is normal)
Range:	Top-attack mode: 150m-2000m Direct-fire mode: 65m-2000m
Missile Arming Window:	65m-75m
Fighting Position Restrictions:	1m x 2m, ventilation is recommended
Guidance System:	Thermal seeker
Sights:	Integrated Day/Night sight unit
Time of Flight:	1,000m = approx. 4.6 sec 2,000m = approx. 14.5 sec
Sight Magnification:	4X day, 4X and 9X night

Table F-1. Javelin technical characteristics.

a. **Command Launch Unit.** The nondisposable section of the Javelin is the command launch unit (CLU) (Figure F-1, page F-2). The night sight and day sight of the Javelin are integrated into one unit. The thermal sight has a 3,000-meter plus range, under

most conditions, which greatly increases target acquisition by the infantryman. The sight can operate for over four hours on a single battery and requires no coolant bottles. It has a built-in test capability, which alerts the gunner if the system is not functioning properly during operation.

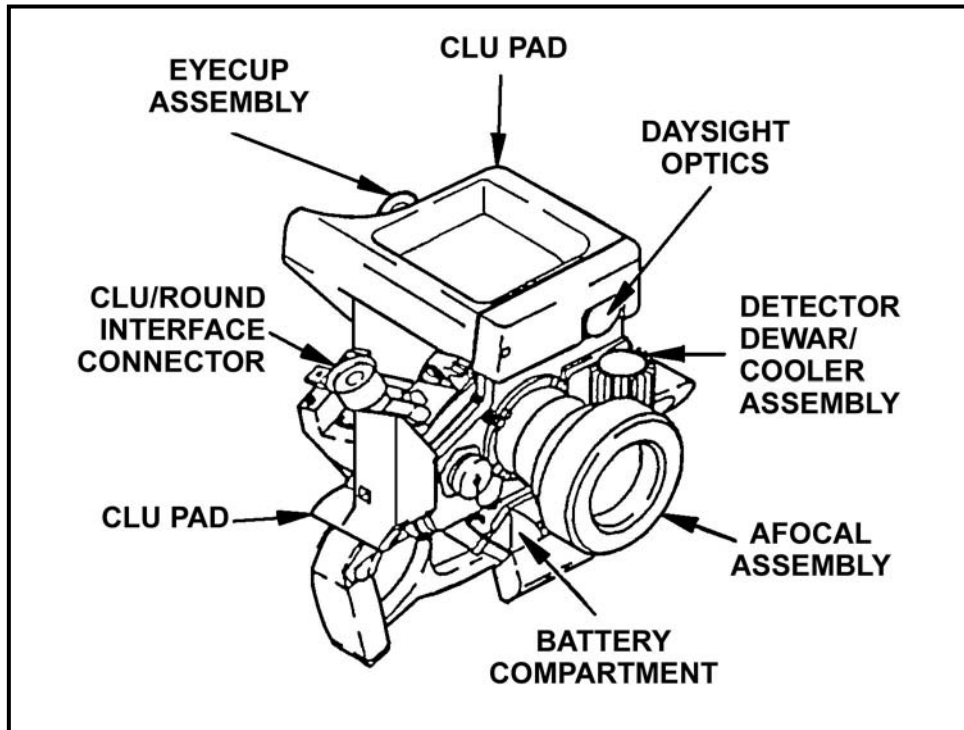

Figure F-1. Command launch unit.

b. **Missile.** The missile is contained in a disposable launch tube. It has a passive imaging infrared system, which locks on to the target before launch and is self-guiding. It uses a tandem shaped charge warhead and a two-stage solid propellant with a low signature, soft-launch motor, and a minimum smoke flight motor. The launch tube assembly and missile is shown in Figure F-2.

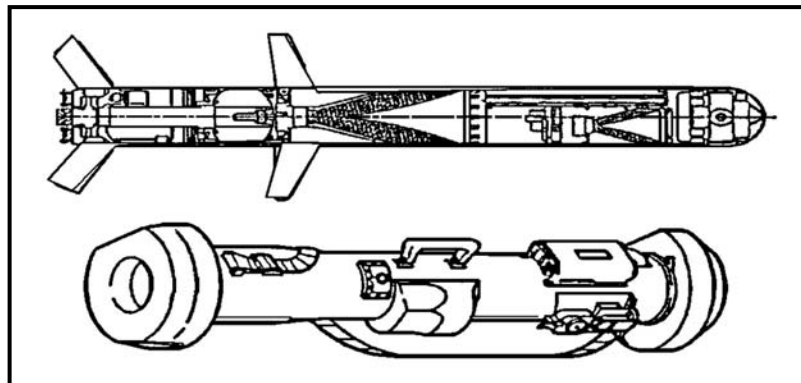

Figure F-2. Launch tube assembly and missile.

F-2. CAPABILITIES

The Javelin antitank missile has improved capabilities over the Dragon.

a. **Lethality.** The Javelin is more lethal than the Dragon. The Javelin's 2,000-meter plus range and its tandem warhead, which defeats all known armor, enhance the Javelin's lethality.

(1) In the top-attack mode, the missile strikes the thinner armor on the top of an armored vehicle rather than the thicker frontal and side armor plates. Top attack also prevents an enemy target from protecting itself by moving behind frontal cover. When used in urban areas or where obstacles might interfere with the top-attack flight path of the missile, the Javelin can also be fired in the direct attack mode.

(2) The fire-and-forget capability of the Javelin increases the probability of a hit. Because the gunner is no longer exposed to enemy suppressive fires while tracking the target until impact, he can use the missile's flight time to reload, in a covered and concealed position, and begin engaging another target.

b. **Survivability.** The Javelin's low launch signature decreases the enemy's ability to acquire gunners when they fire the missile. All gunner engagement tasks are accomplished before launching the missile, making time of flight irrelevant. The 2,000-meter plus range also places the Javelin gunner outside the armored vehicle's effective coaxial machine gun range. However, he is still within the range of the main gun.

(1) The Javelin uses a passive infrared system for target acquisition and lock-on. This means that it emits no infrared or radar beam, which enemy vehicles or smart munitions, can detect, further increasing the survivability of the Javelin gunner.

(2) The Javelin sight offers the commander a superior observation capability as compared to the Dragon. The Javelin sight can detect targets in excess of 3,000 meters.

(3) Because of the Javelin's low backblast, it can be fired from smaller, harder to locate, better protected positions that give the gunner a greater chance of remaining undetected or, if detected, surviving any suppressive fires.

c. **Agility.** The Javelin is man-portable and relatively lightweight for an antitank missile system, which allows the system to be moved about the battlefield with relative ease. The Javelin's soft launch capability allows it to be fired from inside buildings, bunkers, and other restricted spaces with less disruption to the gunner and less signature to be observed by the enemy. Although flank shots are still the preferred method of engagement, the Javelin's low signature launch and top-attack mode make frontal and oblique engagements more effective than in the past, giving the infantry leader additional options in his antiarmor fires planning and positioning.

d. **Flexibility.** The capabilities of the Javelin give the leader more flexibility in the use and emplacement of his antiarmor systems. This new degree of flexibility challenges the leader to make a careful METT-TC analysis to ensure that he is taking full advantage of the Javelin's capabilities.

(1) The greater range of the Javelin gives the leader a system that complements TOW and 25-mm or tank fires, allowing him to achieve mutual support and greater overlapping fires between the two systems. The Javelin's lethality and more than 2,000-meter range allows the BFVs to concentrate TOW and 25-mm fires on targets at standoff range. This

allows the platoon leader to attack the enemy throughout the depth of his formation with antiarmor fires.

(2) Engaging at maximum standoff ranges and handing off the fight to the Javelin gunners provides more time for the BFVs to be moved to alternate positions and allows the platoon leader to mass fires at the critical time and place on the battlefield.

F-3. LIMITATIONS

There are certain times when the Javelin system is not able to engage targets. These occur either when a target is not exposed long enough for the missile seeker to achieve proper lock on, or when atmospheric conditions interfere with the seeker.

a. **Limited Visibility.** Heavy rain, smoke, fog, snow, sleet, haze, and dust are referred to as limited visibility conditions. The presence of these conditions can affect the gunner's ability to acquire and engage targets with the Javelin, especially when using the day sight of the CLU. The gunner should use the thermal sight of the CLU to acquire targets because it provides the best target image during limited visibility conditions.

b. **Infrared Crossover.** Infrared crossover occurs at least twice in each 24-hour period when the temperatures of soil, water, concrete, and vegetation are approximately the same and the objects all emit the same amount of infrared energy. If there is little difference in the amount of infrared energy between a target and its background, then neither the Javelin CLU nor the missile seeker can see the target well, thus greatly degrading the performance of the Javelin. This situation may last as long as an hour, until either the background or the target changes temperature enough to become detectable.

c. **Target Exposure Time.** Just because a target appears in the open and within range does not always mean a Javelin gunner can acquire it, lock-on it, fire, and hit it. A vehicle must be exposed long enough for the gunner to identify it as a target and then to achieve target lock-on with the Javelin missile seeker. This process is not instantaneous and varies with the skill of the gunner.

F-4. EMPLOYMENT CONSIDERATIONS

The Javelin's primary role is to destroy enemy armored vehicles. When there is not an armored threat, the Javelin can be employed in a secondary role of providing fire support against point targets such as bunkers and crew-served weapons positions. In addition, the Javelin's CLU can be used alone as an aided vision device for reconnaissance, security operations, and surveillance.

a. **Mutual Support.** Javelins should be positioned so they can support other Javelins as firing pairs (Figure F-3), or BFVs, tanks, or AT4s. In terrain that has multiple narrow avenues of approach, the platoon leader may assign them singly. In open terrain, the squad can be positioned to achieve overlapping sectors (Figure F-4). Mutual support prevents the enemy from isolating a portion of the friendly unit and then concentrating on one sector without being subjected to fire from another. If mutual support is achieved, when one Javelin is destroyed or forced to displace, the others can continue covering the assigned sector. As a rule of thumb, gunners should normally be positioned far enough apart so that enemy fires directed at one cannot suppress others.

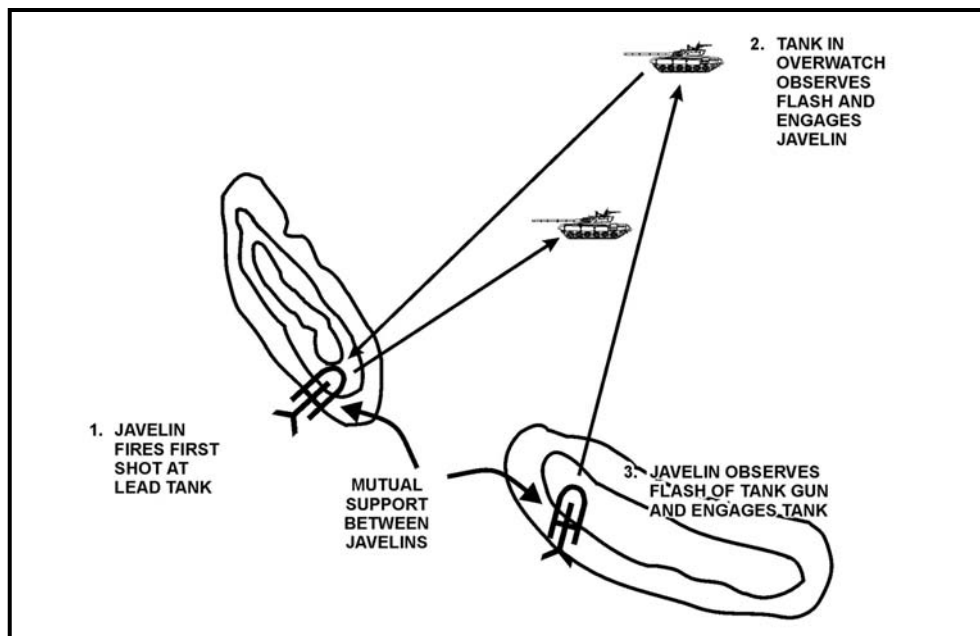

Figure F-3. Employment by firing pair.

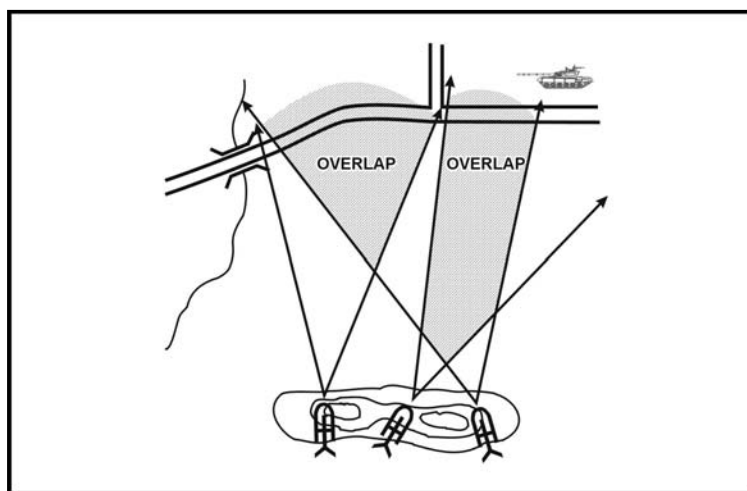

Figure F-4. Overlapping sectors of fire.

b. **F flank Shot Engagements.** Leaders should position Javelins to engage from the flank whenever possible because:

- Armored vehicles are most vulnerable from the flank.
- The focus of the crew will normally be to the front and not to the flank.
- Armored vehicles present the largest visual and infrared target from the flank.
- The vehicle's sighting systems, laser range finder, and firepower are normally oriented to the front, not the flank.
- Armored vehicles have less armor on the sides than on the front. This is important when engaging in the direct-fire mode.

c. **Javelin Standoff Advantage.** The difference between the Javelin's maximum range and the maximum effective range of the enemy tank's coaxial machine gun (Figure F-5) creates an advantage in a standoff. The Javelin's maximum range is 2,000 plus meters. The maximum effective range of a T-72 coaxial machine gun is 1,000 meters. The Javelin gunner should strive to engage enemy tanks in the 1,000- to 2,000-meter range.

NOTE: Most modern tanks, as well as infantry fighting vehicles, can fire high-explosive ammunition to suppress gunners out to 4,000 meters.

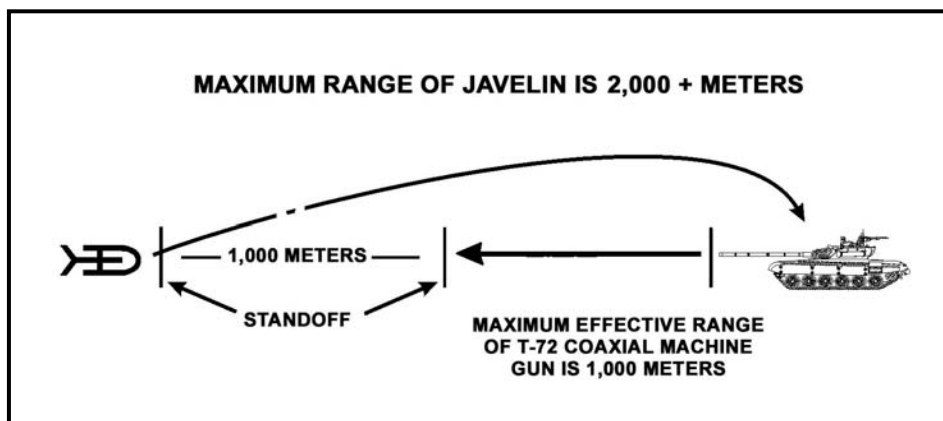

Figure F-5. Standoff range.

d. **Cover and Concealment.** Cover and concealment are critical to the survival of an antiarmor weapon system and its crew. The leader responsible for Javelin employment must analyze cover and concealment along with fields of fire and observation.

(1) **Cover.** Cover is protection from enemy weapons fire and may be natural or man-made. Natural cover includes reverse slopes, ravines, and hollows. Man-made cover includes fighting positions, walls, rubble, and craters.

(2) **Concealment.** Concealment is the ability to hide from enemy observation. Soldiers should avoid unnecessary movement, stay low and observe, and present themselves and their equipment using the lowest silhouette possible. They should alter familiar shapes by breaking up the common outlines of the position and equipment using vegetation and camouflage netting. They must pay attention to the varied colors and textures of the area to ensure the position blends in with its background. Additionally, noises, such as engines running, talking, and moving equipment, can be heard by enemy patrols and observation posts. Shiny surfaces can reflect light for great distances; therefore they must not expose anything that shines.

e. **Soldier's Load.** When employing the Javelin in the dismounted role, the soldier's load becomes important. With a total system weight of just under 50 pounds, the Javelin is heavy. Although a man-portable weapon, one soldier cannot easily carry the Javelin cross country for extended periods. Leaders should be aware of this problem and address it as they would any other soldier's load difficulty. FM 21-18 discusses soldier's load and cross-leveling equipment during movement to reduce the burden on soldiers. Leaders

should develop unit SOPs that identify and describe the details of unit equipment cross leveling.

f. **Massed Fires.** Massed fires are achieved by coordinating the total effects of the platoon's combat power at the decisive place and time to gain favorable results against the enemy. The platoon achieves mass through mutual fire support, detailed fire control, and fire distribution measures that synchronize all of the fires of the platoon's weapon systems and elements. The Javelin should always be positioned so that its fires are part of a cohesive combination including small arms, BFV/tank antiarmor, mortar and artillery, as well as the close-in fires of the squads using AT4 light antiarmor weapons.

F-5. JAVELIN EMPLOYMENT DURING URBAN COMBAT

Javelins provide overwatching antitank fires during the attack of a built-up area and an extended range capability for the engagement of armor during the defense. Within built-up areas, they are best employed along major thoroughfares and from the upper stories of buildings to attain long-range fields of fire. The missile's minimum arming range and flight profile could limit firing opportunities in the confines of densely built-up areas.

a. **Restrictions.** Ground obstacles and water does not restrict the Javelin, with its fire-and-forget capability. However, with its unique flight characteristics, overhead obstacles can limit its use in urban terrain. In the top-attack mode, the Javelin missile requires up to 160-plus meters of overhead clearance (Figure F-6). In the direct-attack mode, the Javelin requires up to 60-plus meters of overhead clearance (Figure F-7, page F-8). Gunners must ensure that sufficient overhead clearance is available along the missile flight path before engaging targets in an urban environment.

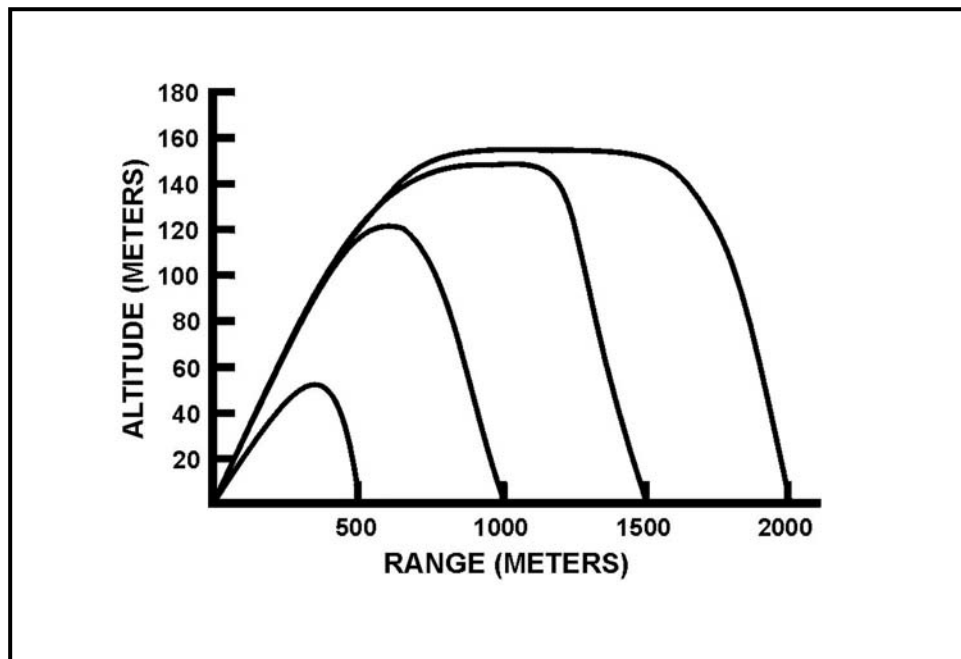

Figure F-6. Javelin flight profile in top-attack mode.

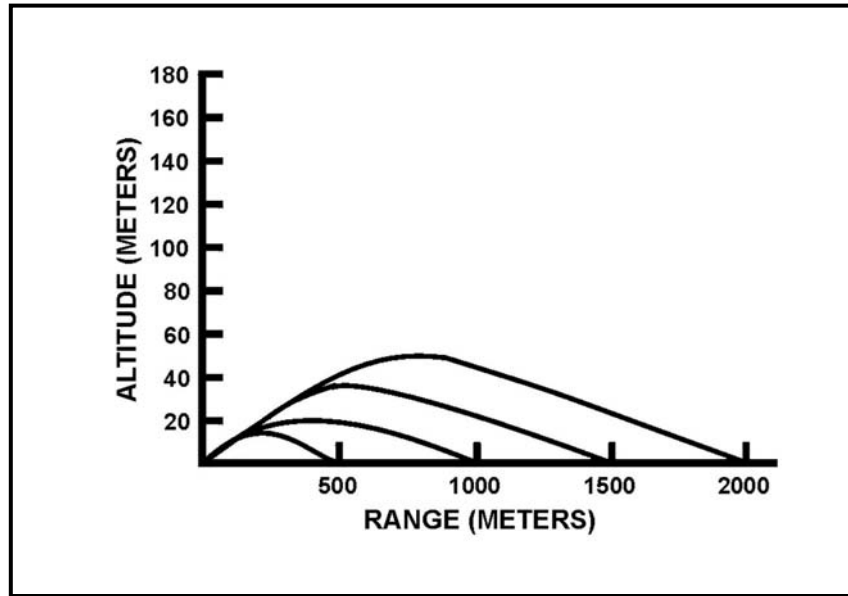

Figure F-7. Javelin flight profile in direct-attack mode.

b. **Dead Space.** The aspects of dead space that affect Javelin fires the most are arming distance and target and background temperature differences.

(1) The Javelin missile has a minimum-arming window of 65 to 75 meters. Few areas in the inner city permit fires much beyond the minimum arming distance. Ground-level long-range fires down streets or rail lines and across parks or plazas are possible. The Javelin may be used effectively from the upper stories or roofs of buildings to fire into other buildings.

(2) The Javelin gunner must take into consideration the targeting dead space sometimes caused by the background of the target and its heat signature. When firing from the upper stories of a building towards the ground, the missile seeker sometimes cannot discriminate between the target and surrounding rubble, buildings, or paving if that background material has the same temperature as the target.

c. **Backblast.** The Javelin's soft launch capability enables the gunner to fire from within an enclosed area (Figure F-8) with a reduced danger from backblast overpressure or flying debris. Personnel within the enclosure should still wear a helmet, protective vest, ballistic eye protection, and hearing protection. To fire a Javelin from inside a room, the following safety precautions must be taken:

- Ceiling height must be at least 7 feet.
- The floor size of the room should be at least 15 feet by 12 feet.
- Window opening must be at least 5 square feet
- Door opening must be at least 20 square feet
- When launching a missile from an enclosure, allow sufficient room for the missile container to extend beyond the outermost edge of the enclosure.
- All personnel in the room must be forward of the rear of the weapon.

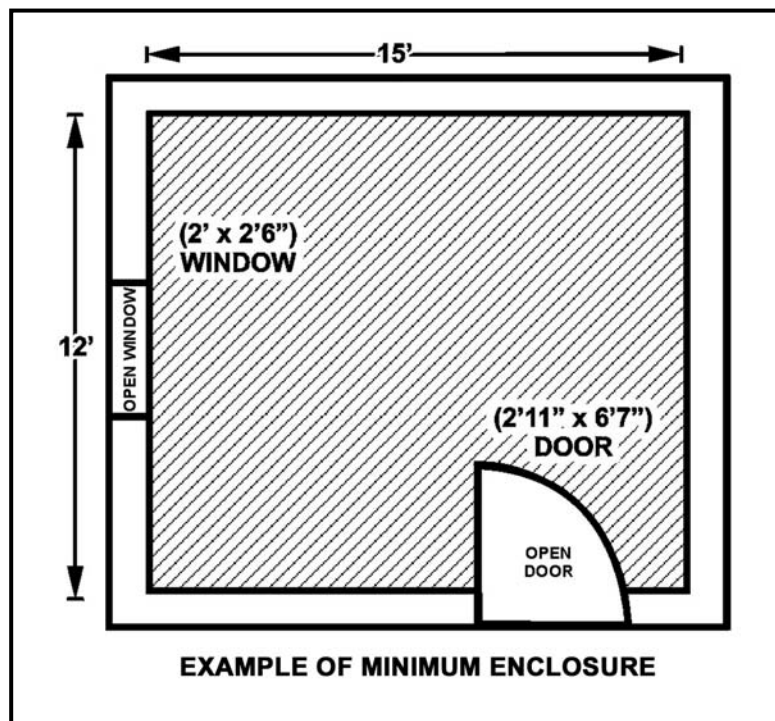

Figure F-8. Minimum room enclosure for Javelin firing.

d. **Weapon Penetration.** The warhead of the Javelin can achieve significant penetration against typical urban targets. Penetration, however, does not mean a concurrent destruction of the structural integrity of a position. When engaging a position in a building, the gunner must use the direct-attack mode to hit the target. When engaging a position or bunker in the open, the gunner may use either the top-attack or direct-attack mode.

F-6. JAVELIN FIRING POSITIONS

Each Javelin gunner should have a primary firing position and at least one alternate position. Depending on the factors of METT-TC, a supplementary position may also be assigned. A Javelin firing position must allow for target engagement, and provide protection for the soldiers and the weapon system. When selecting firing positions, leaders should consider the following:

- Cover to the front, flank, and overhead.
- Concealment from ground and aerial observation.
- Good observation and fields of fire.
- Covered and concealed routes to and between positions.
- Mutual support between squad positions and with other elements.
- Below ridgelines and crests, preferably on the sides of hills.
- Avoid positions in swampy areas and very steep hillsides, as well as positions on or near prominent terrain features.

a. **Types of Javelin Positions.** The platoon leader should consider what type of positions he needs for his key weapons, including the Javelin. If time and material are available, the standard Javelin fighting position with overhead cover should be used. If

time or material is short, then the platoon leader may opt to have his squads prepare flush positions. This paragraph discusses the advantages and disadvantages of the two types of Javelin positions.

(1) **Standard Javelin Fighting Position with Overhead Cover.** The standard Javelin fighting position has cover to protect gunners from direct and indirect fires (Figure F-9). It is a fairly large position with room for the Javelin gunner and another squad member, and their equipment. The position should be concealed among irregularities in the terrain and be well camouflaged.

(a) Advantages of this position are:

- Provides most protection against direct and indirect fire.
- Protects equipment from elements.

(b) Disadvantages of this position are:

- Requires extensive Class IV items or cut timber.
- Requires extensive labor and may require engineer assistance or demolitions.
- Creates large, distinctive silhouette, difficult to hide completely in open terrain.

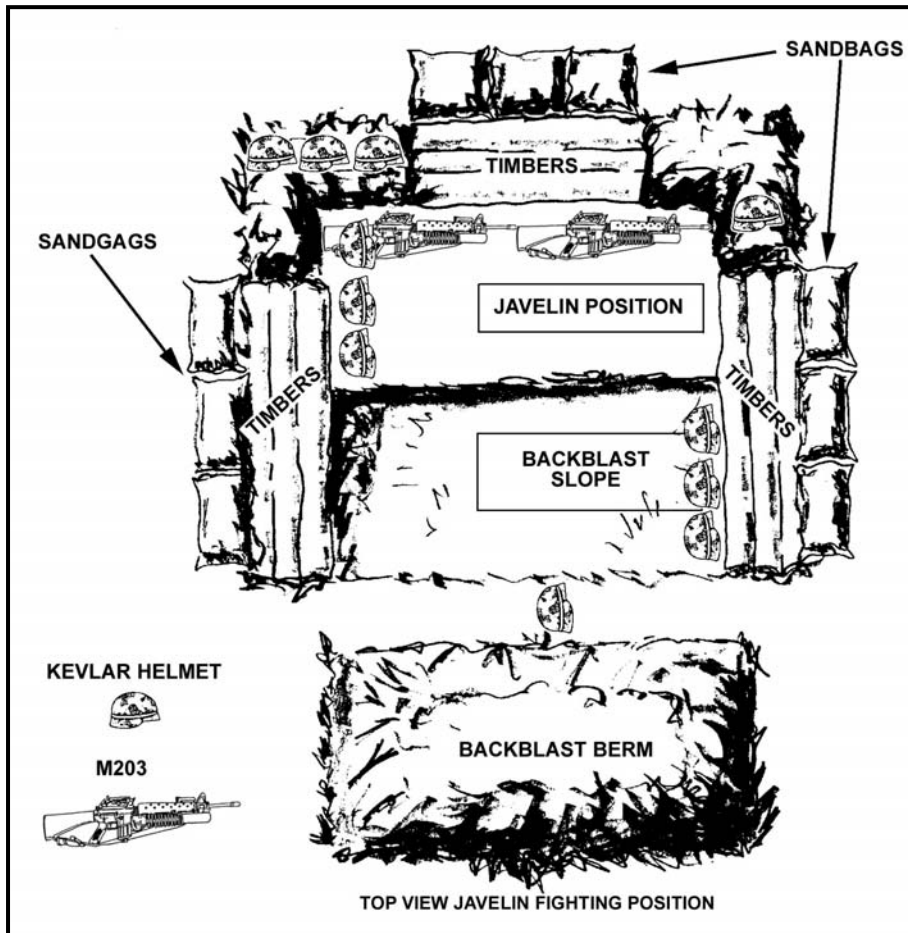

Figure F-9. Standard Javelin fighting position.

(2) **Flush Position.** The flush position (Figure F-10) is a hasty position that does not provide overhead protection for the gunner during firing. The position is basically a hole dug to approximately armpit depth. Overhead cover can be prepared either to the center or the flanks of the position.

(a) Advantages of this position are:

- Allows the Javelin gunner to reposition quickly.
- Less labor intensive (more positions built in same amount of time).
- Requires less Class IV than the standard Javelin position.

(b) Disadvantages of the position are:

- No overhead protection.
- Gunner not protected from indirect fires while in the target acquisition and firing sequence.
- Thermal signatures of gunner and assistant gunner not hidden.
- Gunner movements are easier to detect by the enemy.

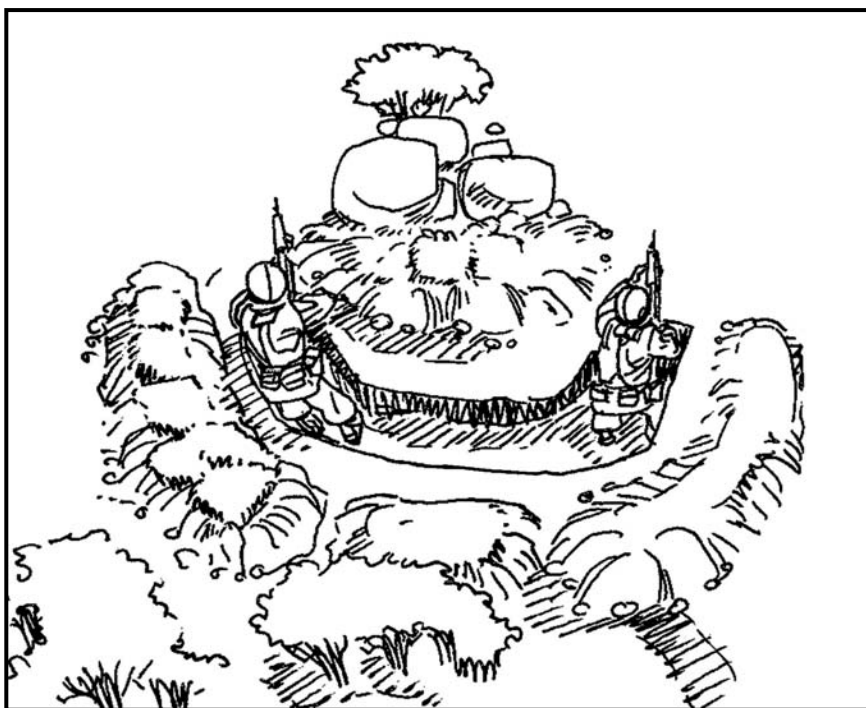

Figure F-10. Flush fighting position.

b. **Occupation of Firing Positions.** Javelin gunners should be careful to avoid detection while occupying a firing position; carelessly occupying a well-concealed position can result in the position being compromised.

c. **Preparation.** The squad should prepare and improve a firing position from initial occupation until it is vacated. These actions include digging in, preparing a range card, and camouflaging the position. Once the position has been dug, it must be camouflaged using sod, leaves, brush, grass, or any other natural material. Camouflage nets or other man-made materials can also be used, but these work best if mixed with natural materials. Gunners must be ready to fight, even while preparing and improving the position. They

must constantly observe the sector of responsibility to allow quick reaction if the enemy appears before the position is completely occupied.

d. **Movement Between Firing Positions.** Most enemy armor forces consider antitank guided missile systems to be critical targets. They expect antitank fires and will react immediately to suppress them. Because of this, Javelin gunners must be prepared to move to their alternate positions when the platoon or squad leader directs. The platoon or squad leader must coordinate the movement of their Javelins so that all of the weapons are not moving at once. Once the enemy has been destroyed, the leader can move the Javelins back to their primary firing position. Platoon fire plans must consider the amount of time needed to move Javelins between positions on the battlefield. The plans must also provide alternate methods of destroying or disrupting the enemy to offset problems associated with movement. These alternate methods include mutual support of BFVs and tanks; incorporation of obstacles and obscurants; and employing indirect fire, CAS, and attack helicopters, if available.

e. **Routes Between Positions.** The squad leader must personally reconnoiter all routes to alternate and supplementary positions. The routes to, from, and between positions should offer cover and concealment and should allow the gunner to enter the firing position from a direction opposite to the enemy's location.

F-7. TARGET ACQUISITION, RECOGNITION, AND IDENTIFICATION

US forces must engage targets quickly and efficiently to win in combat. Speed of target engagement depends on each Javelin gunner's proficiency in acquiring targets, identifying targets, and determining whether targets can be engaged. Dust and smoke make locating and identifying the enemy difficult. As the battle progresses, and friendly and enemy units merge into the same maneuver area, acquiring and identifying targets become crucial tasks. Gunners should be trained to acquire enemy targets that are camouflaged or partially concealed by terrain, vegetation, or smoke. They should also be trained to identify targets as friend or foe. Once soldiers know where to look, they must know how to detect enemy targets rapidly.

a. **Primary Analysis.** Because the Javelin's primary targets are armored vehicles, specifically tanks, gunners should look for terrain where these targets are most likely to appear. Understanding armor tactics and the characteristics of armor vehicles can help Javelin gunners recognize the terrain where these vehicles are most likely to be employed.

(1) **Enemy Analysis.** The tactics of many potential adversaries stress using speed and massive firepower to overwhelm and destroy an opposing force. This dictates a very high average daily rate of advance. To move consistently at a high rate, armored forces require firm ground to move rapidly and enough space to deploy, maneuver, and fire. High-speed avenues of approach, such as road networks, broad ridges, and flat or rolling terrain, should be observed constantly.

(2) **Terrain and Weather Analysis.** A detailed analysis of the terrain and weather is useful in pinpointing armored or mechanized avenues of approach and to evaluate them from the enemy's viewpoint. Some questions that the leader should ask himself are "How can the enemy use this terrain?" and "Where is he most likely to appear first?" Because weather significantly affects the trafficability of terrain, a ground reconnaissance is needed to obtain current, detailed information about roads, trails, manmade objects,

density of trees and brush, and the seasonal conditions of streams and rivers. If a ground reconnaissance is not possible, an aerial reconnaissance should be conducted or recent aerial photographs should be used.

(3) ***Armored and Mechanized Vehicles' Mobility Characteristics.*** Javelin gunners can more easily determine where to look for enemy armored vehicles if they know the vehicles' mobility characteristics. If possible, tank and motorized rifle units will avoid terrain or obstacles that can stop or impede their movement. Terrain factors that restrict armored or mechanized vehicle mobility include:

- Slopes steeper than 30 degrees.
- Sturdy walls or embankments 3 or more feet high.
- Ditches or gullies 9 or more feet wide and 3 or more feet deep.
- Hardwood trees 10 inches or larger in diameter and 10 feet or less apart.
- Water obstacles at least 5 feet deep.
- Very swampy or very rough, rocky terrain.
- Built-up areas where vehicles are restricted to moving on confined roads, through park areas, or across sports fields.

b. **Range Estimation.** Javelin gunners do not need to know the exact range to a enemy target before engaging; they only need to know when it is in range. To speed this determination, gunners use a maximum engagement line. A Javelin maximum engagement line is an imaginary line drawn across a sector's maximum allowable range from a Javelin firing position. To determine the location of this line on the ground, the squad leader or gunner identifies terrain features at or near maximum range. Therefore, any target that crosses or appears short of this line should be within range. Establishing a maximum engagement line greatly reduces target engagement times, especially for targets that seem to be near maximum range. Several range-determination techniques can be used to find the maximum range line or the range to specific targets.

(1) ***Laser Range-Finding Method.*** Most units and all FIST teams should have laser range-finders. The range from the Javelin position to an easily identifiable terrain feature can be easily determined with the laser range-finder. Once the maximum engagement line is determined, the gunner makes a note of a terrain feature at that location on his range card. Any vehicle nearing that feature will be in range.

(2) ***Object Recognition Method.*** Range determination by object recognition is simple and can be accurate with training. The soldier looks at the target with his naked eye, sights through 7X binoculars, or uses a Javelin optical sight. Targets listed in Table F-2, page F-14, are recognizable out to the ranges indicated—for example, if a target can be recognized with the naked eye as an armored or wheeled vehicle, it is probably within 2,000 meters. When using this method, the gunner must consider terrain, visibility conditions, and target size.

TARGETS	RANGE (meters)	
	NAKED EYE	7X SCOPE
Tank crew members	500	2,000
Soldiers, machine gun, mortar	500	2,000
Antitank gun, antitank missile launchers	500	2,000
Tank, APC, truck (by model)	1,000	4,000
Tank, howitzer, APC, truck	1,500	5,000
Armored vehicle, wheeled vehicle	2,000	6,000

Table F-2. Range determination recognition method.

(3) *Map and Terrain Association Method.* The maximum engagement line can be determined from a map. Do this for each firing position as follows:

- Draw an arc on the map across the assigned sector of fire at 2,000 meters.
- Examine the map to identify the distinctive natural or man-made terrain features that the line touches.
- Study the terrain in the sector of fire using binoculars or the Javelin CLU until all the selected terrain features are located and positively identified.
- Connect these features by an imaginary line from the maximum engagement line.

F-8. PRINCIPLES OF FIRE CONTROL

Effective fire control requires a unit to rapidly acquire the enemy and mass the effects of fire in order to achieve decisive results. The following principles are fundamental to achieving effective fires. When planning and executing direct fires, the platoon leader and squad leaders should apply these principles of fire control (refer to Appendix G for a detailed discussion of principles of fire control):

- Mass the effects of fire.
- Destroy the greatest threat first.
- Avoid target overkill.
- Employ the best weapon for the target.
- Minimize friendly exposure.
- Minimize the chances for fratricide.

F-9. FIRE CONTROL MEASURES

Fire control measures must enable Javelin gunners to effectively distribute or mass fires into a given area and over time. Fire control measures are the means by which the platoon leader or subordinate leaders control fires. Application of these concepts, procedures, and techniques assists the unit in acquiring the enemy, focusing fires on him, distributing the

effects of the fires, effectively shifting fires, and preventing fratricide. At the same time, no single measure is sufficient to effectively control fires. At the platoon level, fire control measures will be effective only if the entire platoon has a common understanding of what the fire control measures mean and how to employ them. When executing direct fires, the platoon leader and squad leaders should apply these methods of fire control (refer to Appendix D for a detailed discussion of methods of fire control):

- Distribution of fires over a given area.
- Massing of fires into a given area.
- Distribution of fires over time.
- Massing of fires in time and space.
- Target reference points.
- Trigger lines and phase lines.
- Engagement priorities.

F-10. SELF-DEFENSE AGAINST HELICOPTERS

Because Javelin positions are selected to cover enemy armor avenues of approach, the long-range fields of fire afforded by these positions also enable Javelin gunners to engage aircraft. Testing has shown that Javelin gunners can successfully engage helicopters in unit self-defense.

a. **Weapons Control Status.** The weapons control status established for air defense weapons applies to Javelin gunners too. Unless ordered otherwise, gunners should only fire in unit self-defense; for example, only engage aircraft that are attacking friendly positions.

b. **Self Defense Engagements.** A Javelin gunner can automatically engage an enemy helicopter that is attacking its position. The gunner's target engagement sequence is the same as against ground targets. The Javelin should be in the direct-fire mode when engaging helicopters. The rotors of the helicopter may interfere with the sensors of the missile in the top-attack mode and result in erratic flight of the missile and a target miss.

APPENDIX G

FIRE CONTROL AND DISTRIBUTION TECHNIQUES

Suppressing or destroying the enemy with direct fires is fundamental to success in close combat. Effective direct fires are essential to winning the close fight. Because fire and movement are complementary components of maneuver, the BFV platoon leader must be able to effectively mass the fires of all available resources at critical points and times to be successful on the battlefield. Effective and efficient direct fire control means that the platoon acquires the enemy rapidly and masses the effects of direct fires to achieve decisive results in the close fight.

Section I. PRINCIPLES OF DIRECT FIRE CONTROL

Effective direct fire control requires a unit to rapidly acquire the enemy, mass effects of fires, and achieve decisive results in the close fight. When planning and executing direct fires, the platoon leader and subordinate leaders must know how to apply several fundamental principles. The purpose of these principles of direct fire is not to restrict the actions of subordinates. Applied correctly, these principles help the platoon to accomplish its primary goal in any direct fire engagement, to both acquire first and shoot first, and to give subordinates the freedom to act quickly upon acquisition of the enemy. The principles of direct fire control are:

- Mass the effects of fire.
- Destroy the greatest threat first.
- Avoid target overkill.
- Employ the best weapon for the target.
- Minimize friendly exposure.
- Prevent fratricide.
- Plan for extreme limited visibility conditions.
- Develop contingencies for diminished capabilities.

G-1. MASS THE EFFECTS OF FIRE

The platoon must mass the effects of its fires to achieve decisive results. Massing entails focusing fires at critical points, distributing the effects, and shifting to new critical points as they appear. Random application of fires is unlikely to have a decisive effect. For example, concentrating the platoon's fires at a single target may ensure its destruction or suppression; however, this probably will not achieve a decisive effect on the enemy formation, personnel, or position.

G-2. DESTROY THE GREATEST THREAT FIRST

The platoon engages targets in direct relation to the danger they present. If two or more targets of equal threat present themselves, then the platoon engages the closest target first. The platoon marks the defense engagement area so it can determine when to engage various targets and plan these ranges on their sketches and range cards. For example, the platoon should mark the engagement area at the Javelin maximum engagement distance (2,000 meters) to ensure that gunners do not waste missiles. Also, the platoon should

mark the BMP danger area of 1,000 meters to determine when BMPs pose a viable threat.

G-3. AVOID TARGET OVERKILL

The platoon strives to avoid engaging a target with more than one weapon system at a time. To avoid target overkill, the platoon can divide engagement areas into sectors of fire or quadrants to better distribute direct fire among the platoon.

a. The platoon can use many techniques to mark the engagement area. The platoon and company should develop an SOP for dividing the engagement area with both infrared and thermal target reference points so that all elements can distribute fires within the engagement area.

b. Squads and platoons should mark the engagement areas with infrared devices for engagements during limited visibility. The engagement area should also be marked with thermal devices. For example, the platoon can use a mixture of rocks, sand, and diesel fuel inside a fuel drum, ammunition can, or bucket that has burned shortly before dusk to give off a heat source for most of the night.

c. The platoon leader may also designate rates of fire, by weapon system, to avoid target overkill. Predetermining the rates of fire allows the platoon leader to plan for sufficient ammunition for a desired effect on the enemy. The rates of fire are cyclic, rapid, and sustained.

G-4. EMPLOY THE BEST WEAPON FOR THE TARGET

Using the appropriate weapon for the target increases the probability of rapid enemy destruction or suppression. It also conserves ammunition.

a. Target type, range, and exposure are key factors in determining the weapon that should be employed as well as the desired target effects. The platoon leader task-organizes and arrays his forces based on the terrain, enemy, and desired effects of fires.

b. The platoon leaders, squad leaders, and BCs must ensure that they focus the fires of their weapons systems on the targets they should be engaging. For example, the Javelin is used against armored targets at ranges of 2,000 meters for stand-off protection, whereas the M240B machinegun is used to destroy unarmored vehicles and enemy infantry at ranges within 1,000 meters.

G-5. MINIMIZE FRIENDLY EXPOSURE

Units increase their survivability by exposing themselves to the enemy only to the extent necessary to engage him effectively. Natural or manmade defilade provides the best cover. Crews and squads minimize their exposure by constantly seeking effective available cover, attempting to engage the enemy from the flank, remaining dispersed, firing from multiple positions, and limiting engagement times.

G-6. PREVENT FRATRICIDE

The platoon leader must be proactive in reducing the risk of fratricide, especially when it concerns his three rifle squads on the mechanized battle field. He has numerous tools to assist him in the prevention of fratricide. (For a detailed discussion of fratricide avoidance refer to Appendix D).

a. The platoon can use infrared and thermal marking techniques to ensure that adjacent units do not mistakenly fire at friendly forces during limited visibility. The assault element can use the infrared codable Phoenix, infrared chemical lights, blacklight tube lights tied to poles, and many other methods to mark the assault element's progress. The platoon leader must ensure that the enemy does not have night vision capability before marking his soldiers' progress with infrared marking devices.

b. By monitoring the unit locations, the leaders at all levels can ensure that they know the precise locations of their own and other elements and can control their fires accordingly. The platoon leader and the platoon sergeant must know the location of each of the squads.

G-7. PLAN FOR EXTREME LIMITED VISIBILITY CONDITIONS

The BFV is equipped (ISU or IBAS) to engage the enemy during limited visibility at nearly the same ranges that are applicable during the day. Soldiers are equipped with limited visibility equipment that enables them to also engage the enemy during limited visibility at the same ranges that are applicable during the day. However, dense fog, heavy smoke, and blowing sand may significantly reduce the platoon leader's ability to control the direct fires of the platoon if he has not taken those into consideration.

G-8. DEVELOP CONTINGENCIES FOR DIMINISHED CAPABILITIES

A platoon leader usually develops a plan based on having all of his assets available, and makes alternate plans to account for the loss of equipment or soldiers. The platoon leader should develop a plan that maximizes his unit's capabilities while still addressing the most probable occurrence. He should then factor in redundancy within the platoon. For example, he may designate alternate sectors of fire for "A" section that provides him the means of shifting fires if "B" section has been rendered incapable. These contingencies may become items within a unit SOP.

Section II. DIRECT FIRE CONTROL

Acquiring and destroying the enemy is a precursor to direct fire engagement with a vehicle, antiarmor weapon, machinegun, or individual weapon. Leaders must not assume that the unit will be able to see the enemy; they must expect the enemy to use cover and concealed routes effectively when attacking and to make best use of flanking and concealed positions in the defense. Therefore, the platoon must practice innovative techniques of direct fire control and distribution in offensive and defensive operations, especially since the enemy may not have an established or well-known order of battle. This is often the case when conducting stability operations.

G-9. FIRE CONTROL PROCESS

To bring direct fires against an enemy force successfully, leaders must continuously apply the four steps of the fire control process (For a detailed discussion of the fire control process refer to FM 71-1). At the heart of this process are two critical actions: rapid, accurate target acquisition and the massing of fires to achieve decisive effects on the enemy. Target acquisition is the detection, identification, and location of a target in sufficient detail to permit the effective employment of all of the platoons weapons.

Massing entails focusing direct fires at critical points and then distributing the fires for optimum effect. The four steps are:

- Identify probable enemy locations and determine the enemy scheme of maneuver.
- Determine where and how to mass (**focus** and **distribute**) direct fires effects.
- Orient forces to speed target acquisition.
- **Shift** direct fires to refocus or redistribute their effects.

G-10. FIRE CONTROL MEASURES

Fire control measures are the means by which the platoon leader or subordinate leaders control fires. Application of these concepts, procedures, and techniques assists the unit in acquiring the enemy, focusing fires on him, distributing the effects of the fires, effectively shifting fires, and preventing fratricide. At the same time, no single measure is sufficient to effectively control fires. At the platoon level, fire control measures will be effective only if the entire unit has a common understanding of what the fire control measures mean and how to employ them. The following discussion focuses on the various fire control measures employed by the platoon. Table G-1 lists the control measures by whether they are terrain- or threat-based.

TERRAIN-BASED FIRE CONTROL MEASURES	THREAT-BASED FIRE CONTROL MEASURES
Target reference point (TRP)	Fire patterns
Engagement area	Target array
Sector of fire	Engagement priorities
Direction of fire	Trigger
Terrain-based quadrant	Weapons control status
Friendly-based quadrant	Rules of engagement (ROE)
Maximum engagement line (MEL)	Weapons safety posture
Restrictive fire line (RFL)	Engagement techniques
Final protective line (FPL)	

Table G-1. Common fire control measures.

a. **Target Reference Point.** A target reference point (TRP) (Figure G-1) is a recognizable point on the ground that leaders use to orient friendly forces and to focus and control direct fires. In addition, when TRPs are designated as indirect fire targets, they can be used in calling for and adjusting indirect fires. Leaders designate TRPs at probable enemy locations and along likely avenues of approach. These points can be natural or manmade. A TRP can be an established site, such as a hill or a building, or an impromptu feature designated as a TRP on the spot, like a burning enemy vehicle or smoke generated by an artillery round. Friendly units can also construct markers to serve as TRPs. Ideally, TRPs should be visible in three observation modes (unaided, passive IR, and thermal) so they can be seen by all forces. TRPs include the following features and objects:

- Prominent hill mass.
- Distinctive building.
- Observable enemy position.
- Destroyed vehicle.

- Ground-burst illumination.
- Smoke round.
- Laser point.

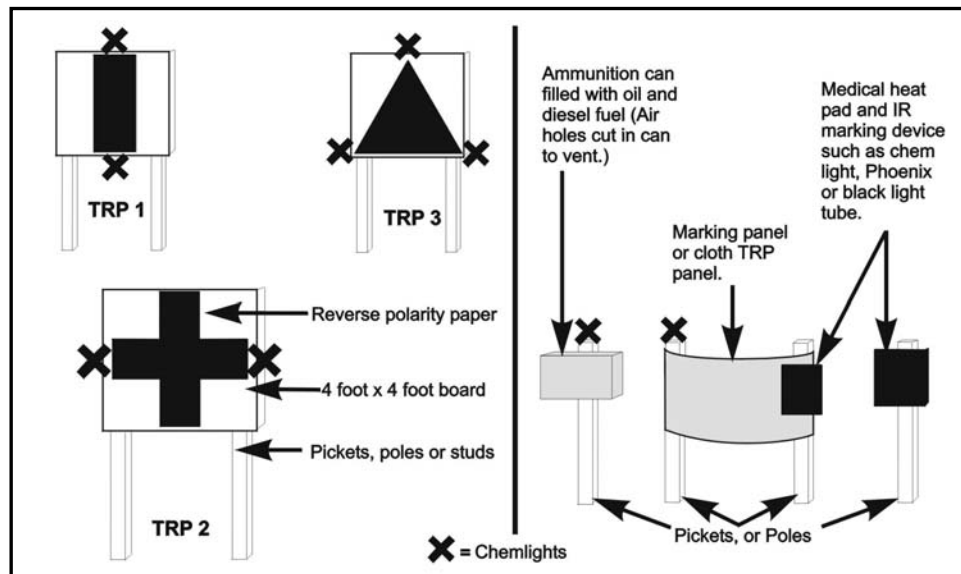

Figure G-1. Example of constructed TRP markers.

b. **Engagement Area.** This fire control measure is an area along an enemy avenue of approach where the platoon leader intends to mass the fires of available weapons to destroy an enemy force. The size and shape of the engagement area are determined by the degree of relatively unobstructed visibility available to the unit's weapon systems in their firing positions and by the maximum range of those weapons. Typically, commanders delineate responsibility within the engagement area (EA) by assigning each platoon a sector of fire or direction of fire; these fire control measures are covered in the following paragraphs.

c. **Sector of Fire.** A sector of fire is a defined area that must be covered by direct fire. Leaders assign sectors of fire to subordinate elements, crew-served weapons, and individual soldiers to ensure coverage of an area of responsibility. They may also limit the sector of fire of an element or weapon to prevent accidental engagement of an adjacent unit. In assigning sectors of fire, platoon leaders and subordinate leaders consider the number and type of weapons available. In addition, they must consider acquisition system type and field of view in determining the width of a sector of fire. For example, while unaided vision has a wide field of view, its ability to detect and identify targets at extended ranges and in limited visibility conditions is restricted. Conversely, most fire control acquisition systems have greater detection and identification ranges than the unaided eye, but their field of view is narrow. Means of designating sectors of fire include the following:

- TRPs.
- Clock direction.
- Terrain-based quadrants.
- Friendly-based quadrants.

d. **Direction of Fire.** A direction of fire is an orientation or point used to assign responsibility for a particular area on the battlefield that must be covered by direct fire. Leaders designate directions of fire for the purpose of acquisition or engagement by subordinate elements, crew-served weapons, or individual soldiers. Leaders most commonly employ direction of fire when assigning sectors of fire because of limited time or insufficient reference points. Means of designating a direction of fire include the following:

- Closest TRP.
- Clock direction.
- Cardinal direction.
- Tracer on target.
- IR laser pointer.

e. **Maximum Engagement Line.** An MEL is the linear depiction of the farthest limit of effective fire for a weapon or unit. The weapon's maximum effective range, the target description, and the effects of terrain determine this line. For example, slope, vegetation, structures, and other features provide cover and concealment that may prevent the weapon from engaging out to the maximum effective range. An MEL serves several purposes for the platoon leader:

- To prevent squads or BFVs from engaging targets beyond the maximum effective ranges of their weapon systems.
- To establish criteria for triggers.
- To depict the maximum extent of the unit's battle space.

f. **Restrictive Fire Line.** An RFL is a linear fire control measure beyond which engagement is prohibited without coordination. In the offense, the platoon leader may designate an RFL to prevent a base of fire element from firing into the area where an assaulting element is maneuvering. This technique is particularly important when BFVs directly support the maneuver of infantry squads. In the defense, the platoon leader may establish an RFL to prevent the unit from engaging a friendly rifle squad positioned in restricted terrain on the flank of an avenue of approach.

g. **Final Protective Line.** The FPL is a line of fire established where an enemy assault is to be checked by the interlocking fires of all available weapons. The unit reinforces this line with protective obstacles and an FPF whenever possible. Initiation of the FPF is the signal for elements, crews, and individual soldiers to shift fires to their assigned portion of the FPL.

G-11. THREAT-BASED FIRE CONTROL MEASURES

The platoon leader uses threat-based fire control measures to focus and control fires by directing the unit to engage a specific, templated enemy element rather than to fire on a point or area. Threat-based fire control measures may be difficult to employ against an asymmetric threat. The following paragraphs describe the TTP associated with this type of control measure.

a. **Fire Patterns.** Fire patterns are a threat-based measure designed to distribute the fires of a unit simultaneously among multiple, similar targets. Platoons most often use them to distribute fires across an enemy formation. Leaders designate and adjust fire patterns based on terrain and the anticipated enemy formation. The basic fire patterns (Figure G-2) are frontal fire, cross fire, and depth fire.

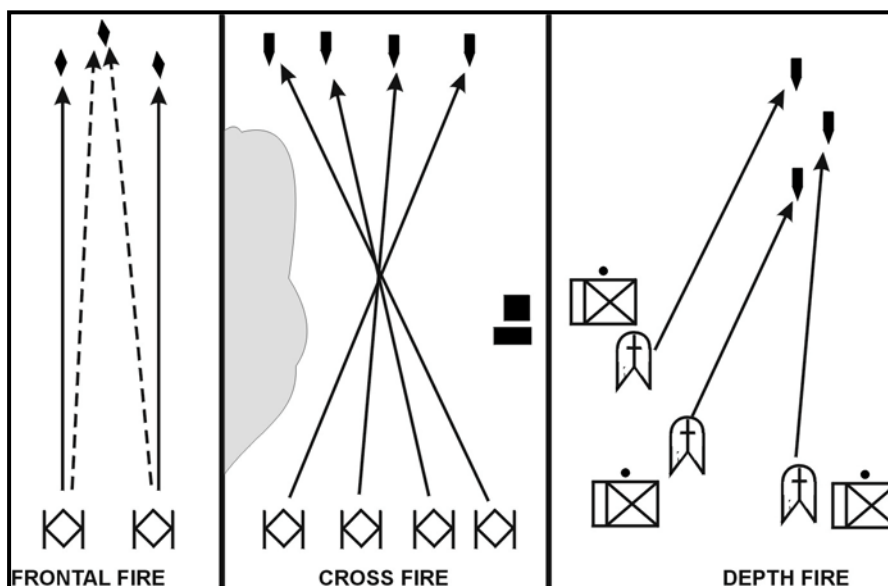

Figure G-2. Fire patterns.

(1) **Frontal Fire.** Leaders may initiate frontal fire when targets are arrayed in front of the unit in a lateral configuration. Weapon systems engage targets to their respective fronts. For example, the left flank weapon engages the left-most target; the right flank weapon engages the right-most target. As they destroy enemy targets, weapons shift fires toward the center of the enemy formation and from near to far.

(2) **Cross Fire.** Leaders initiate cross fire when targets are arrayed laterally across the unit's front in a manner that permits diagonal fires at the enemy's flank or when obstructions prevent unit weapons from firing frontally. Right flank weapons engage the left-most targets; left flank weapons engage the right-most targets. Firing diagonally across an engagement area provides more flank shots, thus increasing the chance of kills. It also reduces the possibility that friendly elements will be detected if the enemy continues to move forward. As they destroy enemy targets, weapons shift fires toward the center of the enemy formation.

(3) **Depth Fire.** Leaders initiate depth fire when targets are dispersed in depth, perpendicular to the unit. Center weapons engage the closest targets; flank weapons engage deeper targets. As they destroy targets, weapons shift fires toward the center of the enemy formation.

b. **Engagement Priorities.** In concert with his concept of the operation, the company commander determines which target types provide the greatest payoff or present the greatest threat to his force. He then establishes these as a unit engagement priority. The platoon leader refines these priorities within his unit.

(1) **Employ the Best Weapons for the Target.** Establishing engagement priorities for specific friendly systems increases the effectiveness with which the unit employs its weapons. As an example, the engagement priority for the BFVs could be enemy personnel carriers (PCs) then dismounted troops.

(2) **Distribute the Unit's Fires.** Establishing different priorities for similar friendly systems helps to prevent overkill and achieve effective distribution of fires. For example, if the commander establishes that Javelins will engage all armored vehicles, the platoon leader may designate the enemy's tanks as the initial priority for one Javelin pair while making the enemy's PCs the priority for the BFV sections.

c. **Weapons Ready Posture.** The weapons ready posture is a means by which leaders use an understanding of the factors of METT-TC to specify the ammunition and range for the engagement. Range selection is dependent on the anticipated engagement range. Terrain visibility, weather, and light conditions affect range selection.

(1) Within the platoon, weapons ready posture affects the types and quantities of ammunition carried by rifle squads and vehicles.

(2) For infantry rifle squads, weapons ready posture is the selected ammunition and indexed range for individual and crew-served weapons. For example, an M203 grenadier whose most likely engagement is to cover dead space at 200 meters from his position might load HEDP and set 200 meters on his quadrant sight. To prepare for an engagement in a wooded area where engagement ranges are extremely short, an antiarmor specialist might dismount with an AT4 instead of a Javelin.

d. **Trigger.** A trigger is a specific set of conditions that dictates initiation of fires. Often referred to as engagement criteria, a trigger specifies the circumstances in which subordinate elements are to engage. The circumstances can be based on a friendly or enemy event. For example, the trigger for a platoon to initiate engagement could be three or more enemy combat vehicles passing or crossing a given point or line. This line can be any natural or manmade linear feature, such as a road, ridgeline, or stream. It may also be a line perpendicular to the unit's orientation, delineated by one or more reference points.

e. **Weapons Control Status.** The three levels of weapons control status outline the conditions, based on target identification criteria, under which friendly elements may engage. The platoon leader sets and adjusts the weapons control status based on friendly and enemy disposition and the clarity of the situation. In general, the higher the probability of fratricide, the more restrictive the weapons control status. The three levels, in descending order of restriction, are—

- WEAPONS HOLD—Engage only if engaged or ordered to engage.
- WEAPONS TIGHT—Engage only targets that are positively identified as enemy.
- WEAPONS FREE—Engage any targets that are not positively identified as friendly.

As an example, the platoon leader may establish the weapons control status as WEAPONS HOLD when friendly forces are conducting a passage of lines. By maintaining situational awareness of his own elements and adjacent friendly forces, however, he may be able to lower the weapons control status. In such a case, the platoon leader may be able to set a WEAPONS FREE status when he knows there are no friendly elements in the vicinity of the engagement. This permits his elements to engage targets at extended ranges even though it is difficult to distinguish targets accurately at ranges beyond 2,000 meters under battlefield conditions. The platoon leader may also establish a different weapons control status for his elements based on situational awareness updates. Weapons control status is extremely important for forces using combat identification

systems. Establishing the weapons control status as WEAPONS FREE permits leaders to engage an unknown target when they fail to get a friendly response.

f. **Rules of Engagement.** ROE specify the circumstances and limitations under which forces may engage. They include definitions of combatant and noncombatant elements and prescribe the treatment of noncombatants. Factors influencing ROE are national command policy, the mission and commander's intent, platoon leader's intent, the operational environment, and the law of war. ROE always recognize a soldier's right of self-defense; at the same time, they clearly define circumstances in which he may fire.

g. **Engagement Techniques.** Engagement techniques are effects-oriented fire distribution measures. The most common engagement techniques in platoon operations are—

- Point fire.
- Area fire.
- Simultaneous (or “volley”) fire.
- Alternating fire.
- Observed fire.
- Sequential fire.
- Time of suppression.
- Reconnaissance by fire.

(1) **Point Fire.** Point fire entails concentrating the effects of a unit's fire against a specific, identified target such as a vehicle, machinegun bunker, or ATGM position. When leaders direct point fire, all the unit's weapons engage the target, firing until they destroy it or until the required time of suppression expires. Employing converging fires from dispersed positions makes point fire more effective because the target is engaged from multiple directions. The unit may initiate an engagement using point fire against the most dangerous threat, then revert to area fire against other, less threatening point targets.

(2) **Area Fire.** Area fire involves distributing the effects of a unit's fire over an area in which enemy positions are numerous or are not obvious. If the area is large, leaders assign sectors of fire to subordinate elements using a terrain-based distribution method such as the quadrant technique. Typically, the primary purpose of area fire is suppression; however, sustaining effective suppression requires judicious control of the rate of fire.

(3) **Simultaneous Fire.** Units employ simultaneous (or “volley”) fire to rapidly mass the effects of their fires or to gain fire superiority. For example, a unit may initiate a support-by-fire operation with simultaneous fire then revert to alternating or sequential fire to maintain suppression. Simultaneous fire is also employed to negate the low probability of hit and kill of certain antiarmor weapons. As an example, a rifle squad may employ simultaneous fire with its AT4s to ensure rapid destruction of a BMP that is engaging a friendly position.

(4) **Alternating Fire.** In alternating fire, pairs of elements continuously engage the same point or area targets one at a time. For example, an infantry platoon may alternate the fires of a pair of machineguns or a vehicle section between vehicles. Alternating fire permits the unit to maintain suppression for a longer duration than does volley fire. It also forces the enemy to acquire and engage alternating points of fire.

(5) **Observed Fire.** Observed fire allows for mutual observation and assistance while protecting the location of the observing element and conserving ammunition. The

company commander may employ observed fire between elements in the company. He may direct one platoon to observe while another platoon engages the enemy. The platoon may use observed fire when it is in protected defensive positions with engagement ranges more than 800 meters. For example, the platoon leader may direct the mounted element to engage the enemy while the infantry squads and weapons squad observe the effects of the fires. The observing elements prepare to engage the enemy on order in case the mounted element fails to effectively engage the enemy, has malfunctions, or runs low on ammunition.

(6) ***Sequential Fire***. In sequential fire, the subordinate elements of a unit engage the same point or area target one after another in an arranged sequence. For example, a platoon may sequence the fires of its four BFVs to gain maximum time of suppression. Sequential fire can also help prevent the waste of ammunition, as when rifle squads wait to see the effects of the first Javelin before firing another. Additionally, sequential fire permits elements that have already fired to pass on information they have learned from the engagement. For example, an infantryman who missed a BMP with AT4 fires could pass range and lead information to the next soldier preparing to engage the BMP with an AT4.

(7) ***Time of Suppression***. Time of suppression is the period, specified by the platoon leader, during which an enemy position or force must be suppressed. Suppression time is typically dependent on the time it will take a supported element to maneuver. Normally, a unit suppresses an enemy position using the sustained rate of fire of its automatic weapons. In planning for sustained suppression, leaders must consider several factors: the estimated time of suppression, the size of the area being suppressed, the type of enemy force to be suppressed, range to the target, rates of fire, and available ammunition quantities.

(8) ***Reconnaissance by Fire***. Reconnaissance by fire is the process of engaging possible enemy locations to elicit a tactical response, such as return fire or movement. This response permits the platoon leader and subordinate leaders to make accurate target acquisition and then to mass fires against the enemy element. Typically, the platoon leader directs a subordinate element to conduct the reconnaissance by fire. For example, he may direct an overwatching section to conduct the reconnaissance by fire against a probable enemy position before initiating movement by the bounding section.

APPENDIX H

RANGE CARDS AND SECTOR SKETCHES

The success of a defense depends on the positioning of soldiers and weapons. To position their weapons effectively, platoon leaders must know the characteristics, capabilities, and limitations of their weapons, the effects of terrain, and the enemy. However, the platoon leader is not done after merely positioning his weapons. He must ensure that each weapon can effectively engage the enemy, and the sum of his weapons can effectively mass coordinated direct fires on the enemy. The platoon leader accomplishes this by making his soldiers produce detailed range cards, by making his squad leaders and section leaders produce detailed, coordinated sector sketches, and by personally inspecting individual soldier positions, reviewing subordinate sector sketches and coordinating with adjacent units to develop a detailed and accurate platoon sector sketch.

Section I. RANGE CARDS

A range card is a sketch of the assigned sector a direct fire weapon system is intended to cover. A range card aids in planning and controlling fires and aids the crews and squad gunners in acquiring targets during limited visibility. It is also an aid for replacement personnel or platoons or squads to move into the position and orient on their sector. The individual soldier or gunner should make the range card so that he becomes more familiar with the terrain in his sector. He should continually assess the sector and, if necessary, update his range card. To prepare a range card, the gunner must know the following information:

- Sectors of fire.
- Target reference points.
- Dead space.
- Maximum engagement line.
- Weapons reference point.

H-1. SECTORS OF FIRE

A sector of fire is a piece of the battlefield for which a gunner is responsible. He may be assigned a primary and a secondary sector. Leaders use sectors of fire to ensure fires are distributed across the platoon's area of responsibility.

a. A sector of fire is assigned to cover possible enemy avenues of approach. Leaders should overlap sectors to provide the best use of overlapping fire and to cover areas that cannot be engaged by a single weapon system.

b. The leader assigns left and right sector limits using prominent terrain features or easily recognizable objects such as large rocks, telephone poles, fences, or stakes.

H-2. REFERENCE POINTS/TARGET REFERENCE POINTS

Leaders designate natural or man-made features as reference points. A soldier uses these reference points for target acquisition and range determination. Some reference points

may also be designated as target reference points. A target reference point (TRP) is an easily recognizable point on the ground (natural or manmade) used to initiate, distribute, and control fires. The company or battalion designates TRPs, and platoon and squad leaders should also designate TRPs. TRPs should always be visible. These may also be useful as indirect-fire targets.

a. The commander or platoon leader designates TRPs used as indirect fire targets so that target numbers can be assigned.

b. TRPs should be visible through all spectrums available to the unit. They must be easily identifiable to the defender during daylight. TRPs must be heated so they can be recognized with thermal sights, and they must have an infrared signature so they can be recognized through night vision devices.

H-3. DEAD SPACE

Dead space is any area that cannot be observed or covered by direct-fire systems within the sector of fire. All dead space within the sector must be identified to allow the platoon leaders, BCs and squad leaders to plan indirect fires (mortars, artillery, or M203) to cover the area. The BFV crew, working with their wingman vehicle crew, must walk the engagement area so gunners can detect dead spaces through the ISU (or IBAS). The squad leader must do the same to identify dead space for his M249s, and the M240B when employed.

H-4. MAXIMUM ENGAGEMENT LINE

The maximum engagement line (MEL) is the depth of the sector is normally limited to the maximum effective engagement range of the weapons systems. However, it can be less if there are objects that prevent the soldier from engaging targets at maximum effective ranges of his assigned weapon. To assist in determining the distance to each MEL, the soldier should use a map to ensure that the MELs are accurately depicted on the range card. Identifying the MEL will decrease ammunition expenditure necessary during an engagement.

H-5. WEAPONS REFERENCE POINT

The weapons reference point (WRP) is an easily recognizable terrain feature on the map used to assist leaders in plotting the vehicle, squad, or weapon position. The WRP is used to assist leaders in plotting positions, and assisting replacement personnel in finding positions.

H-6. PREPARATION PROCEDURES

The individual soldier or gunner prepares two copies of the range card. If alternate and supplementary firing positions are assigned, two copies are required for these as well. A copy is kept with the vehicle, and the other given to the section leader for his sketch.

(3) Dead space (Figure H-5) is shown as an irregular circle with diagonal lines drawn inside. Any object that prohibits observation or coverage with direct fire will have the circle and diagonal lines extend out to the farthest maximum engagement line. If the area beyond the dead space can be engaged, the circle is closed.

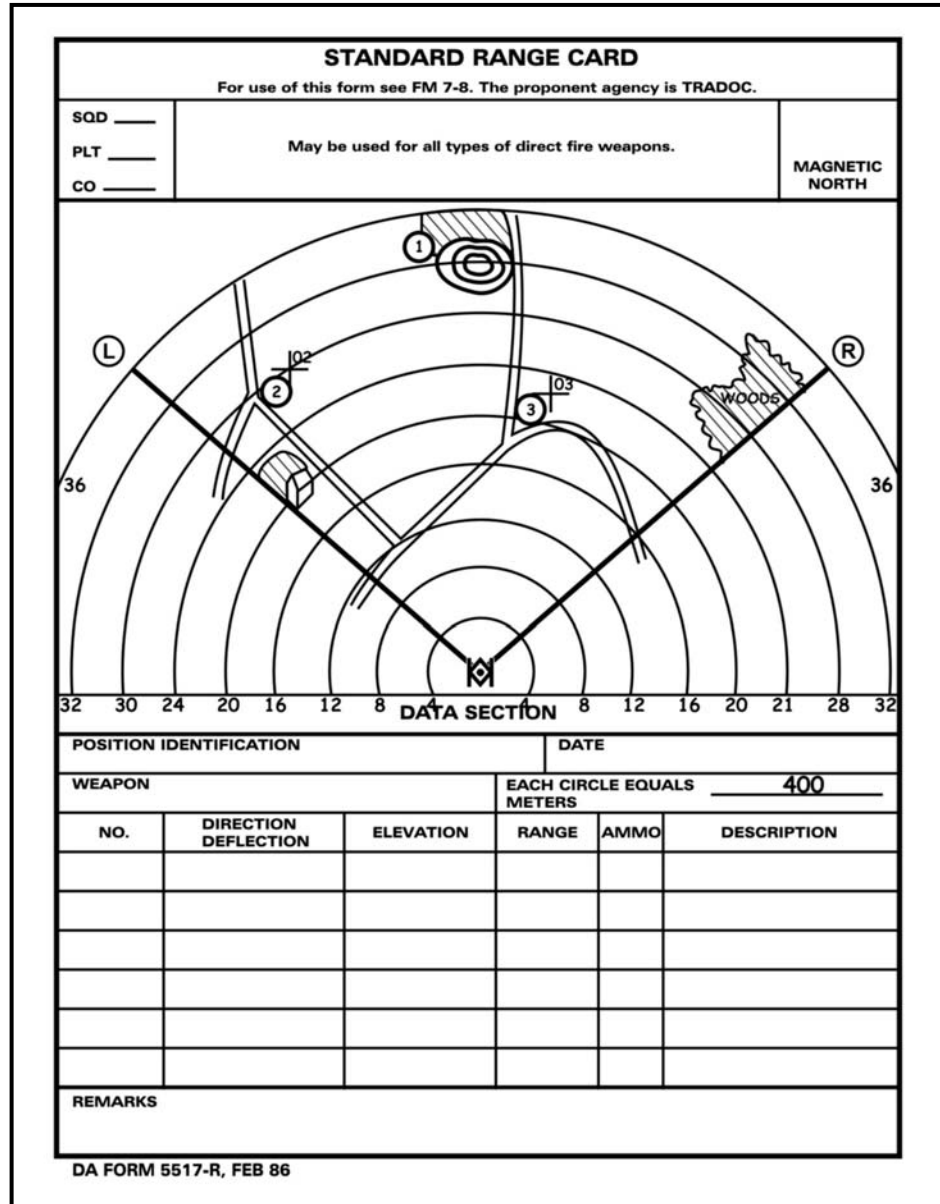

Figure H-5. Dead space.

c. Complete the data section (Figure H-8).

STANDARD RANGE CARD
For use of this form see FM 7-8. The proponent agency is TRADOC.

SQD A22
PLT 2
CO C

May be used for all types of direct fire weapons.

MAGNETIC NORTH

POSITION IDENTIFICATION		PRIMARY A22		DATE 3 MAR / 1140 HRS	
WEAPON M2 C-21			EACH CIRCLE EQUALS METERS 400		
NO.	DIRECTION DEFLECTION	ELEVATION	RANGE	AMMO	DESCRIPTION
L	350° / 5800m	∅ m	2000M	TOW2	FARMHOUSE
R	105° / 920m	+ 10 m	2600M	TOW2	R/SLIDE WOODLINE
1	6400m	+ 30 m	3200M	TOW2	RP-HILLTOP
2	5910m	+ 10 m	2700M	TOW2	TRP-AB002 RJ
3	60m	- 10 m	1800M	TOW2	TRP-AB002 RJ
REMARKS					
4 WRP - RJ AT 13629411, 100° AT 320M					

DA FORM 5517-R, FEB 86

Figure H-8. Example of a completed range card.

(1) **Position Identification.** List primary, alternate, or supplementary. Alternate and supplemental positions must be clearly identified.

(2) **Date.** Show date and time the range card was completed. Range cards are like fighting positions, constantly being updated. The date and time are vital in determining current data.

(3) **Weapon.** The weapon block indicates vehicle type and bumper number (C21, A11).

(4) **Each circle equals _____ meters.** Write in the distance, in meters, between circles.

(5) **NO (number).** Start with L and R limits, then list TRPs and RPs in numerical order.

NOTE: The platoon leader may designate a vehicle to shoot AP, HEI-T, or TOW at targets. This is dictated by platoon SOP or as needed by METT-TC.

(6) **Direction/Deflection.** The direction is in degrees and taken from a lensatic compass. The most accurate technique is to have the gunner aim at the terrain feature, and to have the driver dismount and align himself with the gun barrel and the terrain feature to measure the azimuth. To achieve correct deflection and elevation readings of the terrain feature, select TOW. Show the deflection reading taken from the BFV's azimuth indicator in the deflection block next to the magnetic azimuth.

(7) **Elevation.** Show the gun elevation reading in tens or hundreds of mils. The smallest increment of measure on the elevation scale is tens of mils. Any number other than "0" is preceded by a "plus" or "minus" symbol to show whether the gun needs to be elevated or depressed. Ammunition and range must be indexed to have an accurate elevation reading.

(8) **Range.** This is the distance, in meters, from vehicle position to L and R limits and TRPs and RPs.

(9) **Ammunition.** List types of ammunition used.

(10) **Description.** List the name of the object; for example, farmhouse, wood line, hilltop.

(11) **Remarks.** Enter the WRP data. As a minimum, WRP data include a description of what the WRP is, a six-digit or eight-digit grid coordinate of the WRP, the magnetic azimuth and the distance from the WRP to the vehicle position.

d. Complete the marginal information at the top of the card (Figure H-8).

(1) **Unit Description.** Bumper number, platoon, company, and so on. Never indicate a unit higher than company.

(2) **Magnetic North.** Orient the range card with the terrain and draw the direction of the magnetic north arrow.

Section II. SECTOR SKETCHES

Individual soldiers in squads and BFV gunners prepare range cards. Squad leaders prepare squad sector sketches and section leaders prepare section sector sketches. The platoon leader reviews his squads' and sections' sector sketches and ensures the sketches meet his intent. If he finds any gaps or other flaws, the platoon leader adjusts weapons locations or sectors. Once the platoon leader approves the squad and section sector sketches, he prepares a consolidated report for the company team commander and incorporates this into a consolidated platoon sector sketch. The platoon leader or platoon sergeant physically prepares the platoon sector sketch. The sector sketch can be on acetate taped to a map or it can be a hand drawn sketch. Accurate and detailed sketches aid in direct fire planning, and in direct fire control and distribution.

H-7. SQUAD AND SECTION SECTOR SKETCH

The squad leaders and section leaders make two copies of their sector sketches; one copy goes to the platoon leader, the other remains at the position. The squad leaders and section leaders draw sector sketches (Figure H-9) as close to scale as possible, showing:

- Main terrain features in the sector and the range to each.
- Each primary position.
- Engagement area or primary and secondary sectors of fire covering each position.
- M240B machine gun FPL or PDF (if applicable)
- M249 squad automatic weapon FPLs or PDFs
- Type of weapon in each position.
- Reference points and target reference points in the sector.
- Observation post locations.
- Dead space.
- Obstacles.
- MELs for all BFV weapon systems.
- MELs for Javelin (if applicable) and AT4s.
- Indirect fire targets.

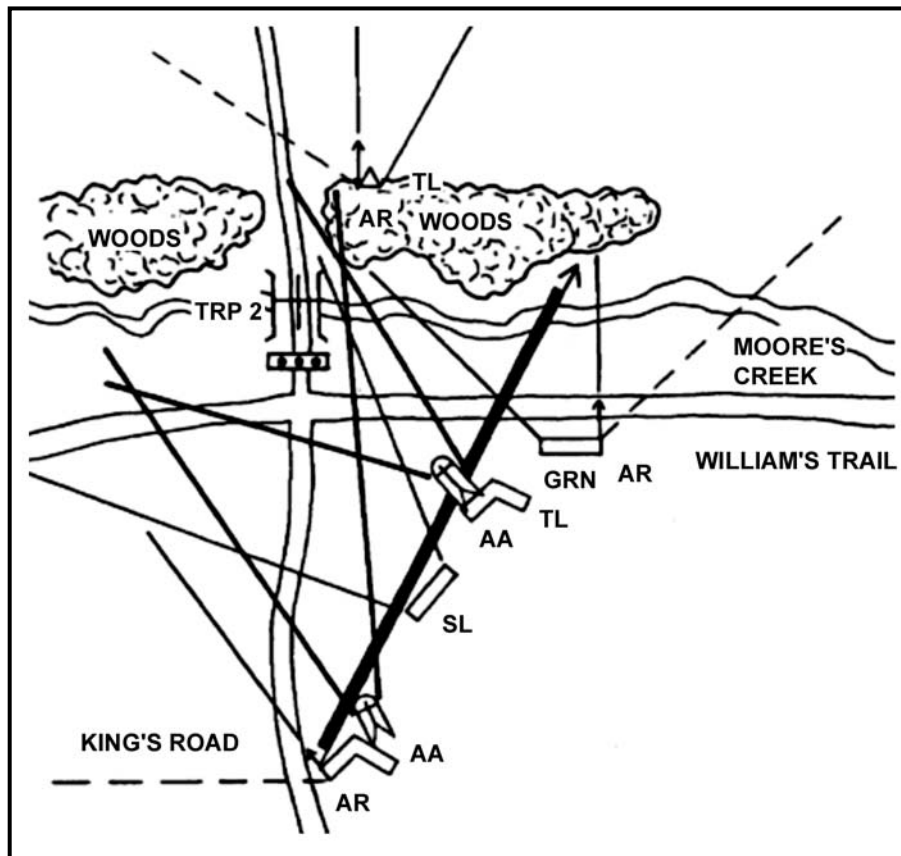

Figure H-9. Squad sector sketch

H-8. PLATOON SECTOR SKETCH

Squad leaders and section leaders prepare their sketches and submit them to the platoon leader. The platoon leader combines all sector sketches (and possibly separate range cards) to prepare a platoon sector sketch. A platoon sector sketch (Figure H-10, page H-14) is drawn as close to scale as possible and includes a target list for direct and indirect fires. One copy is submitted to the company team commander, one copy is given to the platoon sergeant (controlling the mounted element), and one copy is given to the leader of the dismounted element (usually, the platoon leader). As a minimum, the platoon sector sketch should show:

- Primary and secondary sectors of fire or engagement areas.
- Primary, alternate, and supplementary BFV and squad positions.
- Remount points.
- Javelin, M240B, and M249 positions with primary directions of fire.
- M240B and M249 FPLs or PDFs
- MELs for 25-mm, M240C, and TOW.
- Observations posts.
- Target reference points.
- Mines and other obstacles.
- Indirect fire target locations and FPF location (if applicable).
- Position and sector of flanking unit vehicles.
- Priority engagement by weapon system and crew.

NOTE: FBCB2 in M2A3-equipped units provides leaders a more accurate means for recording and sharing sector sketch and range card data. If the platoon leader finds any gaps or other flaws, the platoon leader adjusts weapons locations or sectors. Once the platoon leader approves the squad sector sketches and vehicle range cards, he prepares a consolidated report and incorporates this into a consolidated platoon sector sketch. These locations are forwarded to company (then to battalion) using FBCB2 to plot the requisite no-fire areas and graphic fire control measures.

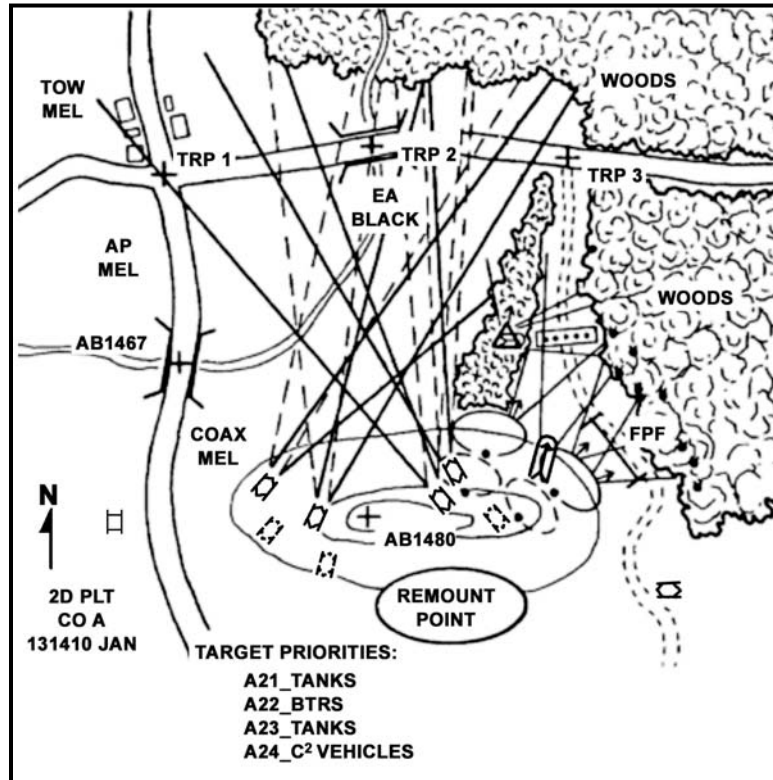

Figure H-10. Platoon sector sketch.

H-9. COORDINATION WITH ADJACENT UNITS

Platoon leaders coordinate with adjacent platoons. Squad leaders coordinate with adjacent squads so that all positions and all platoon and squads are mutually supporting. The platoon leader must ensure that this coordination take place. Coordination is usually initiated from left to right. Gaps between positions are covered by fire as a minimum. Contact points are established to ensure friendly forces meet at some specific point on the ground to tie in their flanks. In many cases, the exchange of sector sketches will accomplish most of this. Typical information that is exchanged includes:

- Locations of primary, alternate, and supplementary positions; sectors of fire for BFVs, M240Bs and Javelins.
- Location of dead space between platoons and how it is to be covered.
- Location of observation posts.
- Location and types of obstacles and how to cover them.
- Patrols (size, type, time of departure and return, and routes).

APPENDIX I
**M2A3 BRADLEY FIGHTING VEHICLE
CONSIDERATIONS**

The mechanized infantry platoon equipped with the M2A3 Bradley fighting vehicle (BFV) has increased capabilities to employ infantry squads and direct- and indirect-fire weapons systems. The mechanized infantry platoon can conduct operations ranging from sustained high-intensity operations to stability operations. Its enhanced lethality, protection, and decision-making tools result from technological improvements in command, control, communications, and computers (C4) and its overall effect on available information. The M2A3 increases the platoon's and squad's abilities to detect, identify, and acquire enemy targets. It also improves direct- and indirect-fire control. The M2A3's command and control (C2) capabilities improve the planning process, which leads to improved situational understanding (SU).

I-1. GENERAL CONSIDERATIONS

The M2A3 BFV enhances the platoon's capabilities to conduct operations with greater *lethality, survivability, C4, sustainability, and mobility*. The M2A3 BFV has more equipment than earlier models. This equipment is also more complex than that on earlier models, which requires more cross training to ensure soldiers can fill vacancies or shortfalls in critical positions. Also, because the M2A3 BFV platoon can transfer more information at every level, leaders and soldiers must work together to manage the information.

a. **Lethality.** The M2A3 BFV features an improved Bradley acquisition system (IBAS), which adds an improved target acquisition subsystem and missile control subsystem. The improvements also include a second-generation, forward-looking infrared radar (FLIR); a thermal sight; a target-designation function; dual-target tracking; an eye-safe laser range finder; an automatic gun-target adjustment; automatic optical alignment; and "hunter-killer" capability. Second-generation FLIR allows the Bradley commander or gunner to identify and acquire targets beyond the range of the vehicle's weapon systems. The IBAS enables the user to acquire, recognize, identify, and automatically track two targets within the same field of view (FOV) and selected magnification, day or night. While moving (or stationary), the M2A3 BFV can use the 25-mm or 7.62-mm to engage either of two targets appearing in the same FOV, from any aspect. While stationary, the M2A3 BFV can use the TOW to engage either of two targets appearing in the same FOV, from any aspect.

b. **Survivability.** Equipment on the M2A3 that helps ensure survivability includes:

- Roof fragmentation protection.
- Mounting capability for reactive armor tiles.
- Aluminum structure with steel applique, spaced laminate steel armor, or both.
- Titanium roof armor.
- Ten-soldier gas particulate filter unit.
- Halon fixed fire extinguisher systems in engine and personnel compartments.
- Portable CO2 fire extinguishers.

c. **Command, Control, Communications and Computers.** Advances in C4 include C2 software, navigational software, digital communications capability, commander’s independent viewer (CIV), and squad leader’s display (SLD). Leaders of the platoon “see” a common battlefield and can see the locations of other platoon elements and known enemy positions relative to their own position. They also have access to the mission’s operational graphics and Force XXI battle command brigade and below (FBCB2) (Table I-1).

EQUIPMENT	CAPABILITIES
PRC-119/OE-254 radio/antenna	Range 8 km*
Command control software:	C2S/VRC-92E – 16 km*
	C2S/VRC-92E/OE-254 – 35 km*
	C2S/PRC-119 – 4 km*
Mini eye-safe laser infrared observation set (MELIOS)	50 to 9,995 meters; provides distance to target from observer; with a compass or vertical angle measurement (C/VAM) provides azimuth to target from observer
* Digital transmission	

Table I-1. Digital communications planning data.

d. **Sustainability.** The M2A3 BFV contains state-of-the-art diagnostic, self-test, and digital logistics reporting via the digital electronics architecture database. The M2A3 BFV sustainment and diagnostic system manages several built-in tests that continually monitor the vehicle and its component functions. These extensive self-tests reduce (but do not omit) the need for manual checks.

e. **Mobility.** The driver’s vision enhancer (thermal) and the navigation display unit work together to improve the driver’s visibility, therefore improving his ability to drive. This M2A3 BFV has relatively unrestricted mobility in total darkness, in any weather conditions, and in degraded visibility conditions. The M2A3 BFV precision navigation system (PNS) consists of a precision lightweight GPS receiver (PLGR), an inertial navigation unit (INU), a precision lightweight GPS, and a vehicle motion sensor (VMS). These components can operate in five modes: integrated GPS/INU/VMS; GPS only (INU sensor failure); INU/VMS (the GPS receiver fails to acquire satellite signal or shows signs of damage); GPS/INU (VMS failure); and INU only (if the unit has neither a GPS receiver nor a VMS).

(1) **Precision Lightweight GPS Receiver.** Normally, the PLGR gives the user precise position coordinates and time and navigational information. If obstructions exist between the satellite and the antenna, the user can enter map coordinates as a way point. When the user picks a way point as a destination, the receiver can provide steering directions, azimuth, and range information to the destination. The PLGR can also show the offset distance from this course line. The PLGR cannot be removed from the BFV and operated in the handheld mode.

(2) **Inertial Navigation Unit.** The INU serves as the main navigational system. The INU works from a gyro-based ring laser. The PLGR supplies the INU with initial position data, and the INU, in turn, supplies the turret processor unit (TPU) with the

BFV's position, velocity, attitude, and angular rate and acceleration (roll, pitch, and azimuth).

I-2. FORCE XXI BATTLE COMMAND BRIGADE AND BELOW

The FFCB2 system comprises a network of computers, global positioning equipment, and communication systems that provide on-the-move, real-time C2 information to tactical combat arms, CS, and CSS soldiers and leaders. FFCB2 serves units performing missions at the tactical level (battalion individual fighting platform).

a. **Information.** The FFCB2 provides a common database with automated friendly positional information. It also provides current tactical battlefield geometry for friendly forces as well as for known or suspected enemy forces. Collectively, the FFCB2 systems generate the friendly operating picture. It displays relevant information, showing the user's location, the location of other friendly forces, observed or templated enemy locations, and all known obstacles. It also provides preformatted, standardized reports, allowing leaders to disseminate graphic overlays and written OPORDs and FRAGOs rapidly. The war-fighter receives data "pushed" from all other battlefield systems to maintain real-time battle information. These battlefield systems draw upon the reports and positional data passed on from the lower tactical internet (TI) to provide information at higher command levels. They push information such as location of adjacent units, known and templated enemy positions, graphics, and OPORDs down to the FFCB2 users.

(1) **Friendly Information.** The FFCB2 screen displays an icon for each friendly vehicle in the company, which provides the BC with a clear picture of the BFV's location relative to the platoon. It also gives the platoon leader a picture of his location relative to the company.

(a) Though the system works automatically on vehicles equipped to operate on the TI, it does not provide locations to every friendly element on the battlefield. For example, the system will not automatically track a dismounted rifle squad operating at extended ranges from an M2A3. Also, it does not cover any nondigitally-equipped units or allied or coalition forces operating next to the platoon.

(b) Icons can be imported into FFCB2 for those elements, based on information received from FM radio reports, but the system will not update the icons in real time. Therefore, the leader cannot rely solely on FFCB2 to clear fires. No system can replace a leader's judgment in preventing fratricide.

(2) **Enemy Information.** FFCB2 displays enemy information from both top-down and bottom-up feeds. The battalion S2 inputs enemy icons into the system based on spot reports (SPOTREPs) generated by the battalion task force (TF) scouts. Based on his analysis, the S2 augments these actual locations with templated positions in the form of a situational template (SITTEMP).

(a) As the platoon conducts operations, it adds to the enemy information by sending SPOTREPs of enemy activity and obstacles on FFCB2. When a BC sends a SPOTREP, he automatically creates an icon representing the enemy on other FFCB2 systems in the platoon. The platoon leader evaluates the validity of the report. Either he or the platoon sergeant forwards it to company, where either the commander or executive officer evaluates it for accuracy, then forwards it to the company's other platoons and to battalion.

(b) To keep the enemy information current, units must update SPOTREPs concerning enemy locations represented by icons on the FBCB2. Elements send updates whenever the enemy situation changes—that is, when they destroy the enemy element or when the enemy element moves. As the information associated with an icon “ages,” the icon fades, eventually disappearing from the FBCB2 screen. Unit SOP should govern the icon “fade” rate.

b. **Architecture.** Each BFV in the platoon has the three basic components of the FBCB2 system (Figure I-1), which communicate with systems at higher levels. Members of the platoon must remember that the FBCB2 can only produce a result (information) as accurate as what goes into it (data from reports received). It may never give a complete or accurate picture of the enemy. The platoon leader, platoon sergeant, section leaders, and squad leaders must ensure that their plans allow for detecting enemy forces not yet reported by digital means.

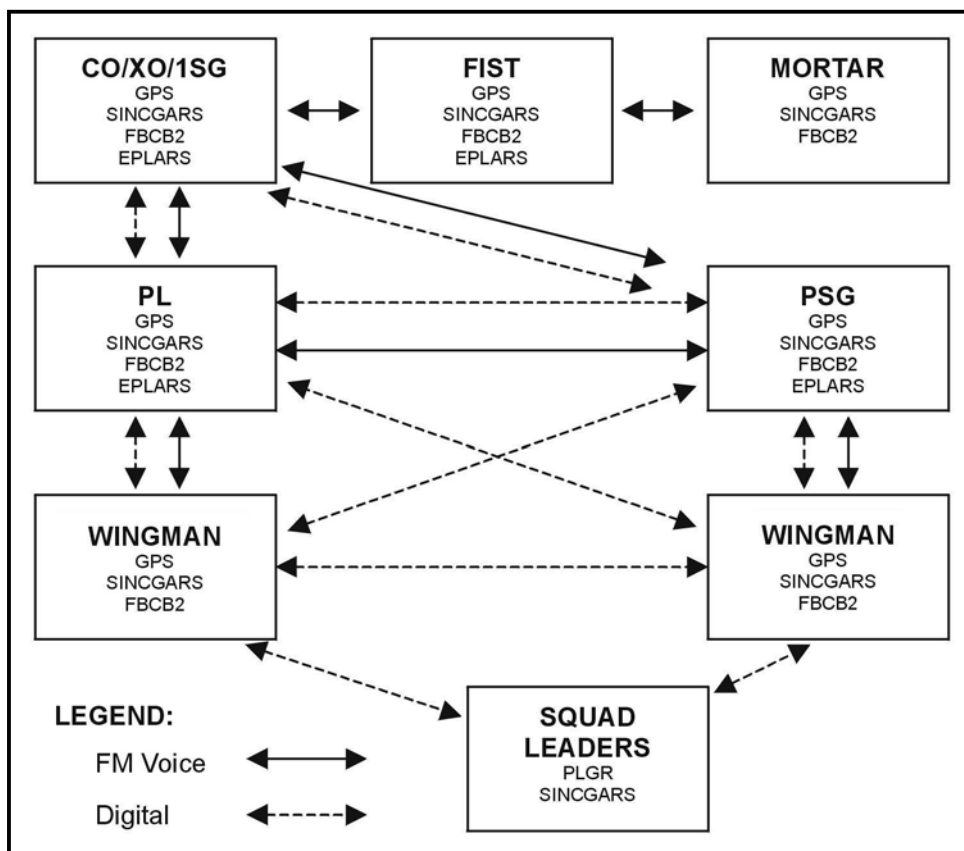

Figure I-1. FBCB2 architecture.

(1) **Global Positioning System.** The GPS provides the precise location, date, and time for reporting real-time friendly locations and for generating laser-designated map spots for reports.

(2) **Single-Channel Ground and Airborne Radio Subsystem.** The single-channel ground and airborne radio subsystem (SINCGARS) provides a secure means of transmitting (both voice and digital) between vehicles in the platoon.

(3) **Enhanced Position Location and Reporting System.** The platoon leader's and platoon sergeant's BFVs also have the enhanced position location and reporting system (EPLRS). This system provides a secure digital connection and serves as a router, efficiently sending message traffic internally within the platoon and out to the company and fire support nets. This routing capability ensures that information passes onward even if physical separation on the battlefield, casualties, or mechanical failures disrupt the chain of command.

(4) **Tactical Internet.** The TI consists of two parts: the lower TI and the upper TI.

(a) **Lower Tactical Internet.** The FBCB2 terminal provides the monitor, keyboard, mouse, and computing functions that allow the crew to access the system. These systems form the lower TI.

(b) **Upper Tactical Internet.** The upper TI consists of a variety of tactical computer systems and communications equipment located mostly at the battalion level and higher. The most important of these are the maneuver control system (MCS), the all-source analysis system (ASAS), the advanced field artillery tactical data system (AFATDS), and the combat service support control system (CSSCS).

c. **FM Radio.** A requirement remains for FM voice message traffic. Platoon leaders use FM to send contact reports to start battle drills, to cue the BCs to check their FBCB2 screens for new information, and to clarify by describing enemy locations, routes, or obstacles verbally. In urban terrain, the FBCB2 cannot display the terrain in sufficient detail to help leaders in making effective decisions, but leaders can use FM radio transmissions to discuss them.

d. **Combat Orders and Graphics.** FBCB2 can increase the speed and precision of the planning process at the platoon level. It lets leaders add or change operational graphics during the planning process or during execution. This ensures that every element has the most current information to control movement and fires. Platoon leaders can use FBCB2 to transmit OPORDs, FRAGOs, and situational updates as free-text messages over extended distances. Unlike FM voice communications, FBCB2 causes no lost time or data. Like the standardized reports, orders and graphics can be stored for retrieval and reference.

e. **Standardized Reporting.** FBCB2 streamlines the reporting process by enabling the platoon to send and receive preformatted, standardized reports (Figure I-2, page I-6). Standardized reports afford several tactical advantages.

- They help to ensure all required information in a particular report or request is included.
- They reduce the chance of errors in transmission.
- They allow the user to store, retrieve, and refer back to messages.

FREE TEXT MESSAGE	REDCON ALERT
Check Fire	Situation Report (SITREP)
Call for Fire	Field Orders ²
Observer Mission Updates ¹	Operations Plan
On-Call Fire Command	Fragmentary Order (FRAGO)
Message to Observer ¹	Warning Order (WARNO)
Fire SPT COORD Measures	Minefield Laying
End of Mission/Surveillance	Overlay
Sequent Adjust	MOPP Alert
Observer Readiness Report	MEDEVAC Report
Airborne Fire Mission	Logistics Report
Spot Report	Personnel Report
Engagement Report	Supply Point Status
Contact Report	Task Management
Land Route Report	LOG Task Order
Obstacle Report	LOG Call for Support
Bridge Report	LOG Task Status
Position Report	LOG Task Sync
NBC 1 Report	Execution Matrix
NBC 4 Report ¹	

¹ Commander's graphic intent (CGI)

² Receive Only

Figure I-2. Preformatted, standardized reports.

I-3. ADDITIONAL RESPONSIBILITIES

Personnel in platoons equipped with the M2A3 have the same responsibilities and duties (highlighted in Chapter 1) as their “analog” counterparts; however, they incur additional responsibilities.

a. **Platoon Leader.** The platoon leader of an M2A3-equipped platoon still bears the responsibility for all that the platoon does or fails to do. His additional list of responsibilities and duties are as follows:

- Monitor his CTD for friendly position updates, overlay updates, and digital reports.

-
- Monitor his CTD so he always knows the positions of the platoon's BFVs relative to the platoon formation, the dismounted rifle squads (if he remains mounted).
 - Ensure the platoon's Bradley commanders use the PNS to enhance navigation.
- b. **Platoon Sergeant.** The platoon sergeant in the M2A3-equipped platoon remains the senior NCO in the platoon. His tactical expertise in platoon operations includes maneuver of the platoon and employment of all weapons. The platoon sergeant must also—
- Control digital reports (information management) during platoon contact to free the platoon leader to maneuver the rifle squads.
 - Ensure soldiers conduct digital precombat inspections during preparation while the platoon leader plans for the upcoming mission.
 - Ensure soldiers understand how to use the PNS when navigating the BFVs.
 - Monitor his CTD to maintain awareness of squad and section positions relative to the platoon and company formation.
- c. **Section Leader.** The section leader in the M2A3-equipped platoon remains mounted and—
- Monitors his CTD for vehicle and section position relative to the platoon formation, digital overlays, and digital reports.
 - Navigates correctly, aided by the PNS.
 - Sends digital SPOTREPs as requested or when the section makes contact.
- d. **Rifle Squad Leader.** The rifle squad leader in the M2A3-equipped platoon bears the responsibility for all the squad does or fails to do. He remains a tactical leader—he leads by example. The rifle squad leader's additional responsibilities include the following:
- Monitor his SLD, while mounted, for friendly position updates, overlay updates, and SITREPs.
 - Monitor his SLD so he always knows the BFV's position relative to the platoon formation and the terrain.
 - Create digital overlays.
 - Create messages (free text or standard format).
 - Initialize the system.
 - Log on and log off the system.
 - Send and receive free-text messages and digital overlays.
 - Send or receive messages and overlays to or from another station.
- e. **Team Leader.** When no squad leader is present in the M2A3 BFV, the team leader assumes the squad leader's responsibilities.

GLOSSARY

AA	assembly area; avenue of approach
AAR	after-action review
AATF	air assault task force
ACE	ammunition, casualties, and equipment; armored combat earthmover
ADA	air defense artillery
AFATDS	advanced field artillery tactical data system
ammo	ammunition
AO	area of operations
A&O	assault and obstacle
AP	armor-piercing; antipersonnel
APC	armored personnel carrier
APDS-T	armor-piercing, discarding sabot, tracer
APSD	armor-piercing, sabot discarding
AR	Army regulation; armor
ASAS	all-source analysis system
ASAS-RWS	all-source analysis system—remote work station
AT	antitank
ATGM	antitank guided missile
AVLB	armored vehicle-launched bridge
BAS	battalion aid station
BC	Bradley commander
BDA	battle damage assessment
BDE	brigade
BFV	Bradley fighting vehicle
BHL	battle handover line
BMNT	begin morning nautical twilight
BMP	threat infantry fighting vehicle
BN	battalion
BOS	battlefield operating systems
BSFV	Bradley Stinger fighting vehicle
BTR	threat personnel carrier
C2	command and control
C4	command, control, communications, and computers
cal	caliber
CAS	close air support
CASEVAC	casualty evacuation
CCP	casualty collection point
CIV	commander's independent viewer
CLU	command launch unit
CM	cruise missile

CO	company; commanding officer
COA	course of action
COP	common operational picture
CP	command post; checkpoint
CS	combat support
CSOP	combat security outpost
CSS	combat service support
CSSCS	combat service support control system
CTD	commander's tactical display
CTT	common training tasks
CVC	combat vehicle crewman
DLIC	detachment left in contact
DPICM	dual-purpose improved conventional munitions
DVE	driver's vision enhancer
EA	engagement area
EBFV	engineer Bradley fighting vehicle
EENT	end evening nautical twilight
EPLRS	enhanced position location and reporting system
EPW	enemy prisoner of war
FA	field artillery
FAAD	forward area air defense
FAC	forward air controller
FBCB2	Force XXI battle command brigade and below
FDC	fire direction center
FEBA	forward edge of the battle area
FFE	fire for effect
FIST	fire support team
FLIR	forward-looking infrared radar
FM	field manual; frequency modulation
FPF	final protective fire
FPL	final protective line
FO	forward observer
FOV	field of view
FRAGO	fragmentary order
FSO	fire support officer
GPS	global positioning system
GS	general support
HE	high-explosive
HEAT	high-explosive antitank
HEDP	high-explosive, dual purpose
HEI-T	high-explosive incendiary-tracer

HEMTT	heavy expanded-mobility tactical truck
HQ	headquarters
IAW	in accordance with
IBAS	improved Bradley acquisition system
ICM	improved conventional munitions
ID	identification
IN	infantry
INU	inertial navigation unit
IR	infrared
ISR	intelligence, surveillance, and reconnaissance
ISU	integrated sight unit
IV	intervisibility
KIA	killed in action
km	kilometer
LC	line of contact
LD	line of departure
LD/LC	line of departure/line of contact
LOC	line of communication
LOGPAC	logistics package
LNO	liaison officer
LZ	landing zone
MANPADS	man-portable air defense system
MBA	main battle area
MCOO	modified combined obstacle overlay
MCS	maneuver control system
MDI	modernized demolition initiator
MDMP	military decision-making process
MEDEVAC	medical evacuation
MEL	maximum engagement line
METT-TC	mission, enemy, terrain and weather, troops available, time, and civil considerations
MICLIC	mine-clearing line charge
mm	millimeter
MOGAS	motor gasoline
MOPMS	modular pack mine system
MOPP	mission-oriented protective posture
MPAT	multipurpose antitank
MRB	motorized rifle battalion
MRE	meal ready-to-eat
MRP	motorized rifle platoon

NAI	named area of interest
NATO	North Atlantic Treaty Organization
NBC	nuclear, biological, chemical
NCO	noncommissioned officer
NEO	noncombatant evacuation order
NLT	not later than
NVD	night vision device
OCOKA	obstacles, cover and concealment, observation and fields of fire, key terrain, avenues of approach
OBJ	objective
OP	observation post
OPCON	operational control
OPLAN	operations plan
OPORD	operations order
OPSEC	operations security
ORP	objective rally point
OT	observer-target
OTN	own the night
PC	personnel carrier
PCC	precombat checks
PCI	precombat inspection
PD	point of departure
PDF	principal direction of fire
PIR	priority intelligence requirements
PL	platoon leader; phase line
PLD	probable line of deployment
PLGR	precision lightweight GPS receiver
PLT	platoon
PMCS	preventive maintenance checks and services
PNS	precision navigation system
POL	petroleum, oils, and lubricants
POSNAV	position navigation
PSG	platoon sergeant
PSYOP	psychological operations
PZ	pickup zone
RATELO	radio-telephone operator
RFL	restricted fire line
RLEM	rifle-launched entry munitions
ROE	rules of engagement
ROI	rules of interaction
RP	release point; red phosphorus

SALUTE	size, activity, location, uniform, time, equipment
SEE	small earth excavator
SHORAD	short-range air defense
SINCGARS	single-channel ground and airborne radio subsystem
SITREP	situation report
SITTEMP	situational template
SLD	squad leader's display
SPOTREP	spot report
SOI	signal operating instructions
SOP	standing operation procedures
SP	start point
SVML	standard vehicle-mounted launcher
TACP	tactical command post
TF	task force
TI	tactical internet
TLP	troop-leading procedures
TM	team; technical manual
TNT	trinitrotoluene (flammable toxic compound used as a high explosive)
TOW	tube-launched, optically tracked, wire-guided (missile)
TP-T	target practice-tracer
TPU	turret processing unit
TRP	target reference point
UAV	unmanned aerial vehicle
UHF	ultra-high frequency
UO	urban operations
US	United States
USMC	United States Marine Corps
VMS	vehicle motion sensor
WARNO	warning order
WIA	wounded in action
WP	white phosphorus
WRP	weapons reference point
XO	executive officer

REFERENCES

Documents Needed

These documents must be available to the intended users of this publication.

FM 21-10*	Field Hygiene and Sanitation. 21 June 2000.
FM 21-11*	First Aid for Soldiers. 27 October 1988.
FM 21-60*	Visual Signals. 30 September 1987.
FM 21-75	Combat Skills of the Soldier. 03 August 1984.
FM 23-1	Bradley Gunnery. 18 March 1996.
FM 23-9	M16A1 Rifle and M16A2 Rifle Marksmanship. 03 July 1989.
FM 71-1	Tank and Mechanized Infantry Company Team. 26 January 1998.
FM 100-14*	Risk Management. 23 April 1998.
ARTEP 7-7J-Drill*	Battle Drills for the Bradley Fighting Vehicle Platoon, Section, and Squad. 08 December 1992.
GTA 05-08-001*	Survivability Positions. 01 August 1993.

Readings Recommended

These readings contain relevant supplemental information.

FM 1-114	Air Cavalry Squadron and Troop Operations. 01 February 2000.
FM 3-06.11*	Combined Arms Operations in an Urban Environment. 28 February 2002.
FM 3-4*	NBC Protection. 29 May 1992.
FM 3-5*	NBC Decontamination. 28 July 2000.
FM 3-23.25(FM 23-25)*	Light Antiarmor Weapons. 30 August 2001.

*This source was also used to develop this publication.

FM 3-23.30(FM 23-30)*	Grenades and Pyrotechnic Signals. 01 September 2000.
FM 3-34.2*	Combined Arms Breaching Operations. 31 August 2000.
FM 3-90	Tactics. 4 July 2001.
FM 5-34	Engineer Field Data. 30 August 1999.
FM 5-103	Survivability. 10 June 1985.
FM 6-22.5(FM 22-5)	Combat Stress. 23 June 2000.
FM 6-30*	Tactics, Techniques, and Procedures for Observed Fire. 16 July 1991.
FM 7-8*	Infantry Rifle Platoon and Squad. 22 April 1992.
FM 7-10	The Infantry Rifle Company. 14 December 1990.
FM 7-90*	Tactical Employment of Mortars. 9 October 1992.
FM 7-91*	Tactical Employment of Antiarmor Platoons, Companies, and Battalions. 30 September 1987.
FM 7-92*	The Infantry Reconnaissance Platoon and Squad (Airborne, Air Assault, Light Infantry). 23 December 1992.
FM 17-95	Cavalry Operations. 24 December 1996.
FM 21-18	Foot Marches. 01 June 1990.
FM 22-51	Leaders' Manual for Combat Stress Control. 29 September 1994
FM 22-100	Army Leadership. 31 August 1999.
FM 23-1	Bradley Gunnery. 18 March 1996.
FM 23-10	Sniper Training. 17 August 1994.
FM 23-14	M249 Light Machine Gun in the Automatic Rifle Role. 26 January 1994.
FM 23-67	Machinegun, 7.62-mm, M60. 29 February 1984.

*This source was also used to develop this publication.

FM 23-90	Mortars. 01 March 2000.
FM 27-10	The Law of Land Warfare. 18 July 1956.
FM 25-101	Battle Focused Training. 30 September 1990.
FM 34-130	Intelligence Preparation of the Battlefield. 08 July 1994.
FM 44-8*	Combined Arms for Air Defense. 01 June 1999.
FM 44-18-1	Stinger Team Operations. 31 December 1984
FM 44-43	Bradley Stinger Fighting Vehicle for Platoon and Squad Operations. 03 October 1995.
FM 44-44	Avenger Platoon, Section, and Squad Operations. 03 October 1995.
FM 90-4	Air Assault Operations. 16 March 1987.
FM 90-7	Combined Arms Obstacle Integration. 29 September 1994.
FM 101-5-1	Operational Terms and Graphics. 30 September 1997.
GTA 07-06-001	Fighting Position Construction Infantry Leader's Reference Card. 01 June 1992.
TC 7-98-1	Stability and Support Operations Training Support Package. 05 June 1997.
TC 21-24	Rappelling. 10 September 1997.
TC 24-20	Tactical Wire and Cable Techniques. 03 October 1988.
TM 9-2350-252-10-1	Operator's Manual for Fighting Vehicle, Infantry, M2; M2A1 and Fighting Vehicle Cavalry, M3; M3A1 Hull. 03 November 1986.
TM 9-2350-252-10-2	Operator's Manual for Fighting Vehicle, Infantry, M2; M2A1 and Fighting Vehicle Cavalry, M3; M3A1 Turret. 22 September 1986.

*This source was also used to develop this publication.

- TM 9-2350-284-10-1 Operator's Manual for High Survivability Fighting Vehicle, Infantry, M2A2 and Fighting Vehicle, Cavalry M3A2 Hull. 15 February 1997.
- TM 9-2350-284-10-2* Operator's Manual for High Survivability Fighting Vehicle, Infantry, M2A2 and Fighting Vehicle, Cavalry M3A2 Turret. 30 April 2001.
- TM 9-2350-294-10-1* Operator's Manual for Fighting Vehicle, Infantry, M2A3, and Fighting Vehicle, Cavalry, M3A3 Hull. 15 September 2000.

*This source was also used to develop this publication.

INDEX

- air assault, 7-10
 - air movement plan, 7-11
 - ground tactical plan, 7-10
 - landing plan, 7-10
 - loading plan, 7-11
 - staging plan, 7-11
 - task force, 7-10
- air defense, 8-22 (illus)
 - passive, 8-26
 - short-range air defense systems, 8-23
 - M6 Bradley Linebacker, 8-23, 8-24 (illus)
 - Stinger MANPADS, 8-23 through 8-25 (illus)
 - Sentinel radar, 8-25, 8-26 (illus)
 - warnings, 8-26
 - weapon control status, 8-23
- angle T, 8-9 (illus)
- automatic fire, B-3
 - characteristics, B-3
 - beaten zone, B-4
 - cone of fire, B-4
 - danger space, B-4
 - maximum ordinate, B-3
 - trajectory, B-3
- classifications of, B-4
 - enfilade, B-4
 - fixed, B-4
 - flanking, B-4
 - frontal, B-4
 - grazing, B-4
 - oblique, B-4
 - plunging, B-4
 - searching, B-4
 - traversing, B-4
 - traversing and searching, B-4
- rates of fire, B-5
 - cyclic, B-5
 - rapid, B-5
 - sustained, B-5
- techniques, B-3
 - assault, B-3
 - direct lay, B-3
 - from a defilade position B-3
 - overhead, B-3
 - types of targets, B-5
 - area, B-5
 - point, B-5
- checkpoints, 7-21
 - deliberate, 7-23 (illus)
- close-air support, 8-16
 - AC-130 gunship, 8-16
- close combat, 1-1
- combat engineer support, 8-20
 - engineer platoon, 8-20
 - assault and obstacle platoon, 8-20
- combat power, 1-2
 - capabilities, 1-3
 - firepower, 1-2
 - information, 1-3
 - leadership, 1-3
 - limitations, 1-4
 - maneuver, 1-2
 - protection, 1-2
 - tactical employment, 1-4
- combat service support, 1-3, 4-9, 5-12, 9-1
 - classes of supply, 9-2
 - development of plan, 9-1
 - resupply, 9-3 through 9-6
 - emergency, 9-5
 - prestock, 9-5
 - routine, 9-3 through 9-5
- combat support, 1-3
- command and control, 2-1
 - components, 2-1
 - leadership, 2-1
- command launch unit, F-1, F-2 (illus)
- command operational picture, 2-2, 2-3
- convoy, 7-12
 - actions at ambush, 7-16 (illus)
 - actions at obstacle, 7-19 (illus)
 - actions during halts, 7-19, 7-20 (illus)
 - actions on contact, 7-15
 - escort, 7-13, 7-14 (illus)
 - independent, 7-15 (illus)

- danger areas, 3-13 through 3-19
 - crossing (dismounted), 3-15 through 3-17
 - small open areas, 3-16, 3-17 (illus)
 - large open areas, 3-15, 3-16 (illus)
 - linear, 3-17, 3-18 (illus)
 - crossing (mounted), 3-13
 - bounding overwatch, 3-14, 3-15 (illus)
 - traveling overwatch, 3-13, 3-14 (illus)
 - enemy contact in, 31-8
 - dead space, H-2, H-7 (illus)
 - defensive operations, 5-1
 - battlefield operating systems, 5-6
 - air defense, 5-12
 - countermobility, 5-9
 - tactical obstacles, 5-9
 - protective obstacles, 5-10
 - wire obstacles, 5-10, 5-11 (illus)
 - obstacle lanes, 5-11
 - fire support, 5-8
 - maneuver, 5-6
 - depth and dispersion, 5-6
 - displacement and disengagement, 5-7, 5-8
 - flank positions, 5-7
 - mobility, 5-9
 - survivability, 5-11
 - characteristics, 5-1, 5-2
 - coordination, 5-25
 - engagement area, 5-12 through 5-16
 - fighting positions, 5-46
 - preparation of, 5-47
 - Stage 1, 5-47, 5-48 (illus)
 - Stage 2, 5-48, 5-49 (illus)
 - Stage 3, 5-49, 5-50 (illus)
 - Stage 4, 5-50, 5-51 (illus)
 - types of, 5-52
 - AT4, 5-57
 - deliberate, 5-58 (illus)
 - hasty, 5-52 (illus), 6-19
 - Javelin, 5-56 (illus)
 - machine gun, 5-55 (illus)
 - one-soldier, 5-53 (illus)
 - three-soldier, 5-54, 5-55 (illus)
 - two-soldier, 5-53, 5-54 (illus)
 - trenches, 5-60 (illus)
- positions, 5-16
 - establishment of, 5-20
 - firing position, 5-20
 - range card, 5-20
 - sector sketches, 5-21
 - occupation of, 5-16 through 5-18
 - security, 5-19
 - observation posts, 5-19
 - weapons placement, 5-22
 - individual BFVs, 5-22
 - Javelin, 5-24
 - M203, 5-25
 - M240B and M249, 5-24
 - rifleman, 5-25
 - retrograde, 5-38
 - delay, 5-46
 - from alternate positions, 5-46
 - from subsequent positions, 5-46
 - retirement, 5-46
 - withdrawal, 5-38
 - disengagement, 5-40 through 5-46
 - not under pressure, 5-38, 5-39 (illus)
 - under pressure, 5-39, 5-40 (illus)
 - sequence, 5-2 through 5-5
 - techniques, 5-26
 - battle position, 5-27 through 5-31
 - in sector, 5-26, 5-27 (illus)
 - perimeter, 5-34, 5-35 (illus)
 - reverse slope, 5-36 (illus), 5-37
 - strong point, 5-31 through 5-34, 6-19
- deviation correction, 8-8
 - deviation spotting, 8-6 (illus)
 - with binoculars, 8-8 (illus)
- formations, 3-1 through 3-9
 - dismounted, 3-5 through 3-9
 - fire team, 3-6
 - file, 3-7 (illus)
 - wedge, 3-6 (illus)
 - squad, 3-7
 - column, 3-7, 3-8 (illus)
 - file, 3-8, 3-9 (illus)
 - line, 3-8 (illus)

- mounted, 3-1 through 3-5
 - coil and herringbone, 3-4, 3-5 (illus)
 - column, 3-1, 3-2 (illus)
 - echelon, 3-4 (illus)
 - line, 3-3 (illus)
 - wedge, 3-2, 3-3 (illus)
 - platoon, 3-9
- field artillery support, 8-13 (*see also* urban operations)
- fragmentary order, 2-5, 2-7
- fratricide, D-1
- indirect fire support, 8-1
- linkup operations, 7-4
 - steps, 7-5
 - planning, 7-5
- maximum engagement line, H-2, H-8 (illus)
- mortar support, 8-12 (*see also* urban operations)
 - types of, 8-12
 - illumination, 8-12
 - smoke, 8-12
 - suppression, 8-12
- movement techniques, 3-9
 - bounding overwatch (dismounted), 3-13
 - bounding overwatch (mounted), 3-11 (illus)
 - traveling (dismounted), 3-12 (illus)
 - traveling (mounted), 3-9, 3-10 (illus)
 - traveling overwatch (dismounted), 3-12 (illus)
 - traveling overwatch (mounted), 3-10 (illus)
- observation posts, 7-21
- offensive operations, 4-1
 - actions on contact, 4-9 through 4-13
 - ambush, 4-25 through 4-32
 - category, 4-26
 - deliberate, 4-26
 - hasty, 4-26
 - formations, 4-26
 - linear, 4-26, 4-27 (illus)
 - L-shaped, 4-27 (illus)
 - type, 4-27
 - antiarmor, 4-31 (illus)
 - area, 4-30 (illus)
 - point, 4-28 through 4-30
- approach march, 4-16
 - advance guard, 4-16
 - flank or rear guard, 4-17
 - main body, 4-17
- attack, 4-18, 4-19 (illus)
 - consolidation, 4-23
 - isolate the objective, 4-22
 - movement to objective, 4-20 through 4-22
 - reconnaissance, 4-19
 - reorganization, 4-24
- battlefield operating systems, 4-8, 4-9
- characteristics, 4-1
 - audacity, 4-2
 - concentration, 4-1
 - surprise, 4-1
 - tempo, 4-2
- counterattack, 4-33
- forms of maneuver, 4-3
 - envelopment, 4-3 (illus)
 - frontal attack, 4-6
 - infiltration, 4-4, 4-5 (illus)
 - penetration, 4-5, 4-6 (illus)
 - turning movement, 4-4 (illus)
- demonstration, 4-33
- feint, 4-33
- raid, 4-32
- search and attack, 4-17
 - organization of forces, 4-17
 - finishing force, 4-18
 - fixing force, 4-18
 - reconnaissance force, 4-17
- sequence, 4-6 through 4-8
- spoiling attack, 4-33
- tactical tasks, 4-34
 - seize, 4-34 through 4-36
 - clear, 4-37 through 4-30
 - general terrain, 4-37
 - restricted terrain, 4-37
 - below ground, 4-39

- suppress, 4-40
- attack by fire, 4-41
- bypass, 4-42
- types of, 4-3
 - attack, 4-2
 - exploitations, 4-2
 - movement to contact, 4-2, 4-13
 - command and control, 4-14
 - defensive considerations, 4-16
 - developing the situation, 4-14
 - techniques, 4-14
 - approach march, 4-14,
 - search and attack, 4-14
 - pursuit, 4-2
- operations (*see also* defensive operations, linkup operations, offensive operations, and urban operations)
- order, 2-5 through 2-7
 - issue, 2-21
- passage of lines, 7-6
 - forward, 7-7
 - planning, 7-6
 - rearward, 7-7
- platoon organization, 1-4, 1-5 (illus)
 - dismounted, 1-5
 - mounted, 1-5, A-1 (illus)
- platoon responsibilities, 1-6
 - Bradley commander, 1-8
 - Bradley driver, 1-8
 - Bradley gunner, 1-8
 - platoon leader, 1-6
 - platoon sergeant, 1-7
 - master gunner, 1-7
 - rifle squad leader, 1-8
 - section leader, 1-7
 - squad members, 1-9
 - antiarmor specialist, 1-9
 - automatic rifleman, 1-9
 - grenadier, 1-9
 - rifleman, 1-9
 - team leader, 1-9
- range cards, H-1
 - completed, H-10 (illus)
- range correction, 8-10
 - bracketing, 8-10
 - hasty, 8-11 (illus)
 - successive, 8-10 (illus)
 - creeping, 8-11, 8-12 (illus)
- range spotting, 8-10
- reconnaissance, 7-1
 - before and after operations, 7-2
 - during operations, 7-2
 - execution, 7-1
 - forms of, 7-3
 - area, 7-4
 - route, 7-3
 - zone, 7-4
 - planning, 7-1
- rehearsal, 2-22
- relief in place, 7-8
 - coordination, 7-8
 - planning, 7-8
 - sequential, 7-9
 - simultaneous, 7-10
- rifle-launched entry munitions, 6-13 (illus)
- roadblocks, 7-21
- rules of engagement, G-9
- sector sketches, H-11
 - squad and section, H-12 (illus)
 - platoon, H-13, H-14 (illus)
- target reference point, G-4, G-5 (illus), H-1
- troop-leading procedures, 2-6 through 2-22
 - course of action, 2-7
 - analysis, 2-19
 - comparison and selection, 2-20
 - development, 2-17 through 2-19
 - mission analysis, 2-7 through 2-17
 - reconnaissance, 2-20
- urban operations, 6-1
 - breach, 6-7
 - ballistic, 6-7, 6-11
 - conduct of, 6-10
 - explosive, 6-7, 6-11

- locations, 6-13
- mechanical, 6-7, 6-13
- clearing techniques, 6-16
- consolidation, 6-17
- combat multipliers, 6-29
 - antiarmor weapons, 6-35
 - attack helicopters, 6-34, 8-18
 - characteristics, 8-18
 - weapon systems, 8-19
 - field artillery, 6-34
 - mortars, 6-32
 - high-explosive ammunition, 6-33
 - illumination, 6-33
 - position selection, 6-32
 - role, 6-32
 - snipers, 6-35
- fighting positions, 6-24
- hasty defense, 6-19, 6-20 (illus)
- obstacles, 6-22 (illus), 6-26
- organization, 6-2, 6-3 (illus)
 - assault element, 6-3
 - breach team, 6-4
 - support element, 6-4, 6-8
- reorganization, 6-17

- warning order, 2-4, 2-6, 2-7
- weapons reference point, H-2, H-9 (illus)

FM 3-21.71(FM 7-7J)
20 AUGUST 2002

By Order of the Secretary of the Army:

ERIC K. SHINSEKI
General, United States Army
Chief of Staff

Official:



JOEL B. HUDSON
Administrative Assistant to the
Secretary of the Army
0222110

DISTRIBUTION:

Active Army, Army National Guard, and U. S. Army Reserve: To be distributed in accordance with initial distribution number 110794, requirements for FM 3-21.71.

PIN: 065890-000